

UNIVERSITY OF TORONTO



3 1761 00192662 5

7233P

LIBRARY
OF
M. Van Buren Perley.

Nec scire fas est omnia.



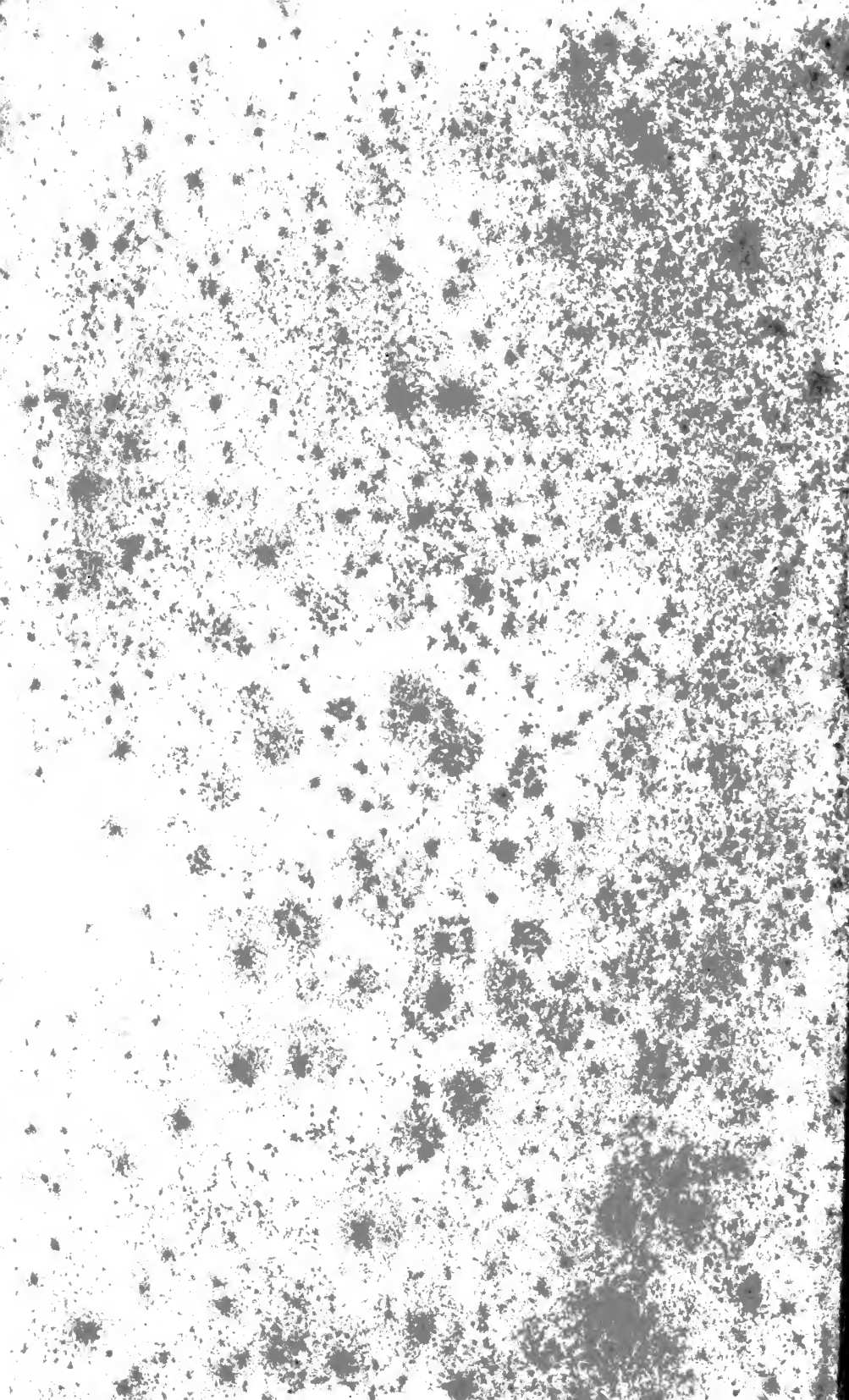



Digitized by the Internet Archive
in 2007 with funding from
Microsoft Corporation



POPULAR LECTURES

ON

SCIENCE AND ART.

VOLUME II.

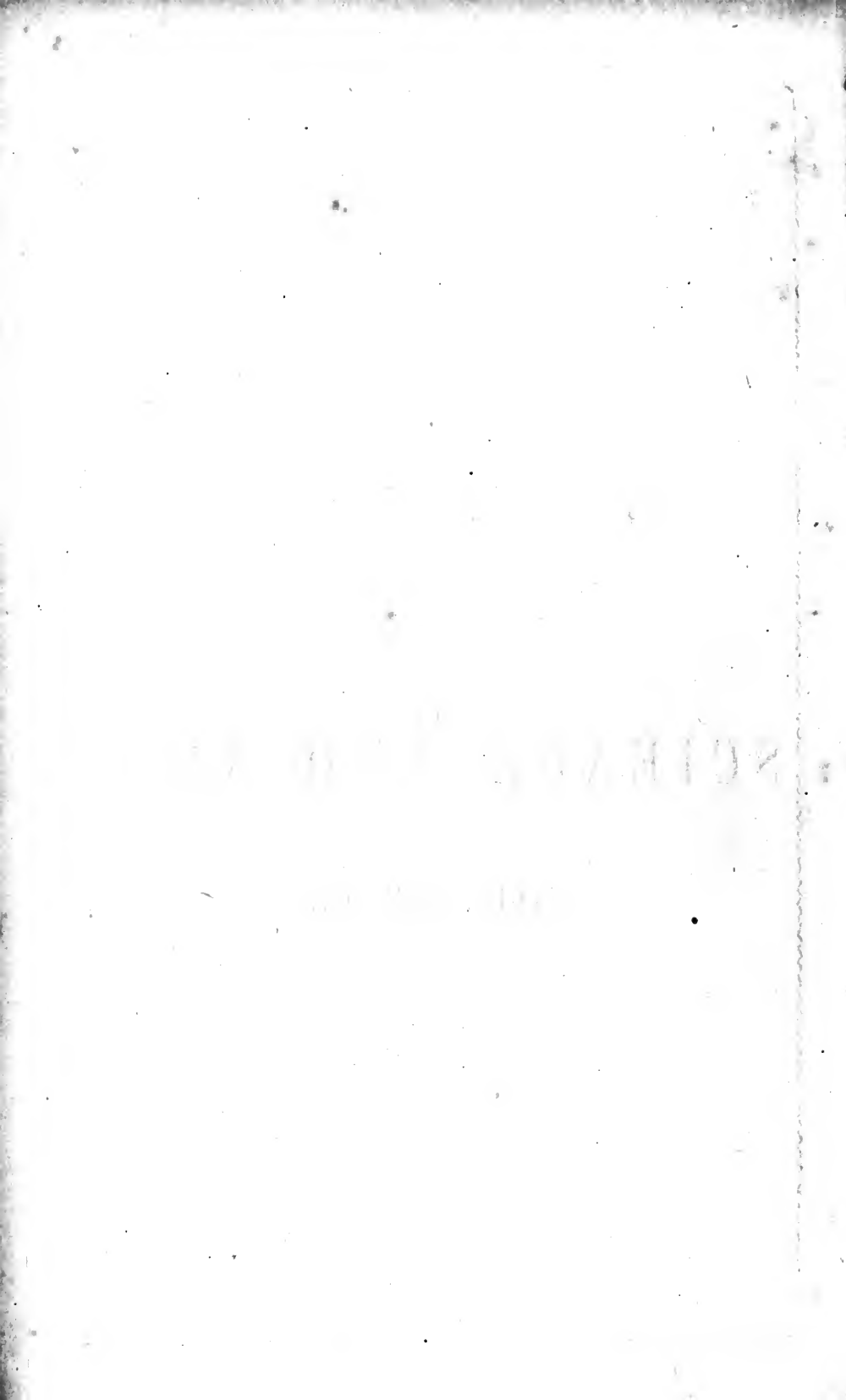

POPULAR LECTURES
ON
SCIENCE AND ART;

DELIVERED IN THE PRINCIPAL
CITIES AND TOWNS OF THE UNITED STATES.

BY
DIONYSIUS LARDNER,

DOCTOR OF CIVIL LAW, FELLOW OF THE ROYAL SOCIETIES OF LONDON AND EDINBURGH—
OF THE ROYAL IRISH ACADEMY, MEMBER OF THE PRINCIPAL EUROPEAN SOCIETIES
FOR THE ADVANCEMENT OF SCIENCE, AND FORMERLY PROFESSOR OF ASTRON-
OMY AND NATURAL PHILOSOPHY IN THE UNIVERSITY OF LONDON.

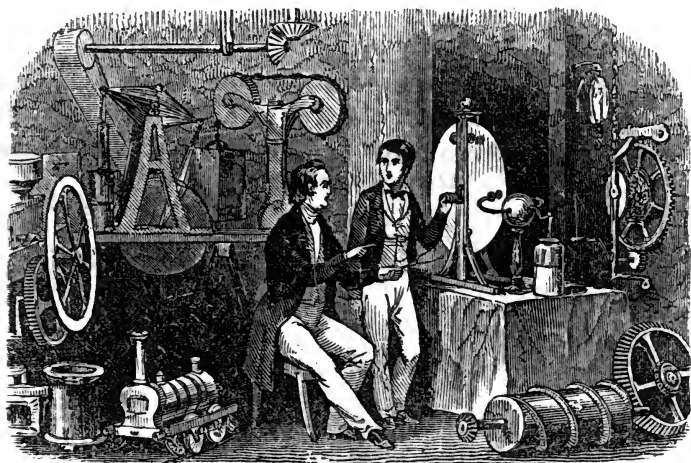

"The most obvious means of elevating the people, is to provide for them works on popular and practical science, freed from mathematical symbols and technical terms, written in simple and perspicuous language, and illustrated by facts and experiments which are level to the capacity of ordinary minds."

LONDON QUARTERLY REVIEW.

IN TWO VOLUMES.
VOL. II.

FIFTEENTH EDITION.

NEW-YORK:
BLAKEMAN AND MASON.
1859.

NOT FOR PUBLICATION

EX 171

L35

1859

V.2

Entered, according to Act of Congress, in the year 1846,

By GREELEY & McELRATH,

the Clerk's Office of the District Court of the United States, in and for the Southern District of New York.

STEREOTYPED BY REDFIELD & SAVAGE,
13 Chambers Street, N. Y.

CONTENTS OF VOLUME I.

[NOTE.—For Analytical Index, see first Volume.]

THE PLURALITY OF WORLDS	PAGE 49
Contemplation of the Firmament.—Reflections thereby suggested.—Limited Powers of the Telescope.—What it can do for us.—Its Effect on the Appearances of the Planets.—Are the Planets inhabited?—Circumstantial Evidence.—Analogies of the Planets to the Earth.—Plan of the Solar System.—Uniform Supply of Light and Warmth.—Expedient for securing it.—Different Distances of the Planets do not necessarily infer different Temperatures, nor different Degrees of Light.—Admirable Adaptation of the Rotation of the Earth to the Organization of its Inhabitants.—The same Provision exists on the Planets.—Minor and Major Planets.—Short Days on the latter.—The Seasons.—Similar Arrangement on the Planets.—The Atmosphere.—Similar Appendage to the Planets.—Many Uses of the Atmosphere.—Clouds.—Rain, Hail, and Snow.—Mountains on the Planets.—Land and Water.—Weights of Bodies on the Planets analogous to Weight on the Earth.—Appearances of the Sun.—Conclusion.	
THE SUN	65
The most interesting Object in the Firmament.—Its Distance.—How measured.—Its Magnitude.—How ascertained.—Its Bulk and Weight.—Its Density.—Form.—Time of Rotation.—Spots.—Its Physical Constitution.—Nature of the Spots.—Luminous Coating.—Its Thickness.—Probable Temperature of the Surface of the Sun.—Nature of its Luminous Matter.	
ECLIPSES	77
Lunar and Solar Eclipses.—Their Causes.—Shadow of the Earth.—Shadow of the Moon.—Magnitude of Eclipses.—When they can happen.—Central Solar Eclipse.—Great Solar Eclipse described by Halley.—Ecliptic Limits.	
THE AURORA BOREALIS	87
Origin of the Name.—Produced by Electricity.—General Phenomena of Auroras.—Various Examples of this Meteor.—Biot's Excursion to the Shetland Isles to observe the Aurora.—Lottin's Observations in 1838-'39.—Various Auroras seen by him.—Theory of Biot to explain these Meteors.—Objections to it.—Hypothesis of Faraday.—Auroras seen on the Polar Voyage of Captain Franklin.	
ELECTRICITY	101
Electric Phenomena observed by the Ancients.—Thales.—Gilbert de Magnete.—Otto Guericke's Electric Machine.—Hawkesbee's Experiments.—Stephen Grey's Discoveries on Electrics and Non-Electrics.—Wheeler and Grey's Experiments.—Dufaye discovers the Resinous and Vitreous Electricities.—Invention of the Leyden Phial.—Singular Effects of the first Electric Shocks.—Experiments of Watson and Bevis.—Experiments on Conductors.—Franklin's Experiments and Letters.—His celebrated Theory of Positive and Negative Electricity.—His Experiments on the Leyden Phial.—His Discovery of the Identity of Lightning and Electricity.—Reception of his Suggestions by the Royal Society.—His Kite Experiment.—His Right to this Discovery denied by Arago.—His Claim vindicated.—Invention of Conductors.—Death of Richmann.—Beccaria's Observations.—Canton's Experiments.—Discovery of Induction.—Invention of the Condenser.—Works of Æpinus.—Theory of Symmer.—Experiments of Coulomb.—Balance of Torsion.—Electricity of the Atmosphere.—Effects of Flame.—Experiments of Volta.—Lavoisier and Laplace.—Analytical Work of Poisson.	

THE MINOR PLANETS	PAGE 141
Classification of the Planets.—Mercury.—Transit over the Sun.—Relative Position with regard to the Sun.—Difficulty of observing it.—Venus.—Diurnal Motion of Venus and Mercury indicated by the Shadows of Mountains.—Direction of the Axis of Rotation—Seasons, Climates, and Zones—Orbits and Transits of Mercury and Venus.—Mountains on Mercury and Venus.—Influence of the Sun at Mercury and Venus.—Twilight on Mercury and Venus.—Mars.—Atmosphere of Mars.—Physical Constitution of Mars.—Has Mars a Satellite?—Appearance of the Sun at Mars.—Its close Analogy to the Earth.	
WEATHER ALMANACS	157
Merits of Weather Almanacs.—Excitability of the London Public.—Fright produced by Biela's Comet.—London Water Panic.—London Air Panic.—London Bread Panic.—Rage for Weather Almanacs.—Patrick Murphy's Pretensions.—Examination of the Predictions of the Weather Almanac.—Their Absurdity.—Comparison of the Predictions with the Event.—Morrison's Weather Almanac.—Charlatanism of these Publications.—Great Frost of 1838 in London.—Other Visitations of Cold.	
HALLEY'S COMET	169
Predictions of Science.—Structure of the Solar System.—Motion of Comets.—How to identify them.—Intervals of their Appearance.—Halley's Comet.—Its History.—Newton's Conjectures.—Sagacity of Voltaire.—Halley's Researches.—Foretells the Reappearance of the Comet in 1759.—Principle of Gravitation applied to its Motion by Clairaut.—Researches of that Mathematician.—Anecdotes of Lalande and Madame Lepaute.—Minute and circumstantial Prediction of the Reappearance of Halley's Comet.—Discovery of the Planet Herschel anticipated by Clairaut.—Reappearance of the Comet at the predicted Time.—Second Prediction of its Return in 1835.—Prediction fulfilled.—Observations on its Appearance in 1835.	
THE ATMOSPHERE	191
Atmospheric Air is material.—Its Color.—Cause of the blue Sky.—Cause of the green Sea.—Air has Weight.—Experimental Proofs.—Air has Inertia.—Examples of its Resistance.—It acquires moving Force.—Examples of its Impact.—Air is impenetrable.—Experimental Proofs.—Elastic and compressing Forces equal.—Limited Height of the Atmosphere.—Elasticity proportioned to the Density.—Experimental Proofs.—Internal and external Pressure on close Vessels containing Air.	
THE NEW PLANETS	203
Indications of a Gap in the Solar System.—Bode's Analogy.—Prediction founded upon it.—Piazzi discovers Ceres.—Dr. Olbers discovers Pallas.—Harding discovers Juno.—Dr. Olbers discovers Vesta.—Indications afforded by these Bodies of the Truth of Bode's Predictions.—Fragments of a broken Planet.—Others probably still undiscovered.—Their ultra-zodiacal Motions.—Their Eccentricities.—They are probably not globular.—Other Singularities of their Appearance.	
THE TIDES	209
Correspondence between the Tides and Phases of the Moon shown by Kepler.—Erroneous popular Notion of the Moon's Influence.—Actual Manner in which the Moon operates.—Influence of the Sun.—Combined Action of the Sun and Moon.—Spring Tides.—Counter-action of the Sun and Moon.—Neap Tides.—Priming and Lagging of the Tides.—Discussions at the British Association.—Whewell's Researches.—Effect of Continents and Islands on the Tides.—General Progress of the Great Tidal Wave.—Velocity of the Tidal Wave.—Range of the Tide.	
LIGHT	221
Structure of the Eye.—Manner in which distant Objects become visible.—Corpuscular Theory.—Undulatory Theory.—Its general Reception.—Velocity of Light.—Account of its Discovery by Roemer.—Measurement of the Waves of Light by Newton.—Color produced by Waves of different Magnitudes.—Magnitudes of Waves of different Color.—Summary View of the Corpuscular Theory.—Summary View of the undulatory Theory.—These Theories compared.—Discoveries of Dr. Young.—Discoveries of Malus, Arago, Poisson, Herschel, and Airy.—Relations of Light and Heat.	
THE MAJOR PLANETS	235
Space between MARS and JUPITER.—Jupiter's Distance and Period.—His Magnitude and Weight.—His Velocity.—Appearance of his Disk.—Day and Night on Jupiter.—Position of his Axis.—Absence of Seasons.—His telescopic Appearance.—His Belts.—Causes of his Belts.—Currents in his Atmosphere.—Mäder's telescopic Views of Jupiter.—Appearance of the Sun as seen from Jupiter.—His Satellites.—The Variety of his Months.—Magnificent Appearance of the Moons as seen from Jupiter.—Their Eclipses.—SATURN.—His diurnal Rotation.—Appearance of the Sun as seen from him.—His Atmosphere.—His Rings.—Their Dimensions.—Biot's Explanation of their Stability.—Herschel's Theory of the same.—Appearances and Disappearances of the Rings.—Various Phases of the Rings.—Saturn's Satellites.—HERSCHEL or URANUS.—His Distance and Magnitude.—His Moons.—Neptune and its wonderful discovery.	
REFLECTION OF LIGHT	257
Ray of Light.—Pencil of Light.—Reflection.—Irregular Reflection.—Regular Reflection.—Different Powers of Reflection in different Bodies.—Reflection at plane Surfaces.—Its Laws.—Image of an Object in a plane Reflector.—Reflection of curved Surfaces.—Concave Reflectors.—Convex Reflectors.—Images in spherical Reflectors.—Illusion of the Air-drawn Dagger.—Effects of com-	

mon Looking-Glasses analyzed.—A flattering Glass explained.—Metallic Specula.—Reflection in Liquids.—Image of the Banks of a Lake or River.

PROSPECTS OF STEAM-NAVIGATION PAGE 267

Paddle-Wheels.—Defects of the present Steam-Vessels as applicable to War.—Difficulty of long Ocean-Voyages.—Ericson's Propeller.—Loper's Propeller.—Advantages of Submerged Propeller.—Method of raising the Propeller out of the Water.—Fuel.—Form and Arrangement of the proposed Steam Packet-Ships.—War-Steamers.—The Princeton.—Effects to ensue from the new Steamships.—Conclusion.

THE BAROMETER..... 277

Maxim of the Ancients.—Abhorrence of a Vacuum.—Suction.—Galileo's Investigations.—Torricelli discovers the Atmospheric Pressure.—The Barometer.—Pascal's Experiment.—Requisites for a good Barometer.—Means of securing them.—Diagonal Barometer.—Wheel Barometer.—Verrier.—Uses of the Barometer.—Variation of Atmospheric Pressure.—Weather-Glasses.—Rules in common Use absurd.—Correct Rules.—Measurement of Heights.—Pressure on Bodies.—Why not apparent.—Effect of a Leather Sucker.—How Flies adhere to Ceilings and Fishes to Rocks.—Breathing.—Common Bellows.—Forge Bellows.—Vent Peg.—Teapot.—Kettle.—Ink-Bottles.—Pneumatic Trough.—Gurgling Noise in decanting Wine.

THE MOON..... 299

Popular Interest attached to the Moon.—Its Distance.—Its Rotation.—Same Face always toward the Earth.—Its Phases.—Its changes of Position with regard to the Sun.—Has it an Atmosphere?—Optical Test to determine it.—Physical Qualities of Moonlight.—Is Moonlight warm or cold?—Does Water exist on the Moon?—Does the Moon influence the Weather?—Mode of determining this.—Physical Condition of the lunar Surface.—Absence of Air and Gases.—Absence of Liquids.—Appearance of the Earth as seen from the Moon.—Prevalence of Mountains upon it.—Their general volcanic Character.—Appearance of the Mountain Tycho.—Heights of lunar Mountains and Depths of Ravines.—Telescopic Views of the Moon by Beer and Mädler.—Detached Views of the lunar Surface.—Condition of a lunar Crater deduced from Analogy.

HEAT..... 317

Heat as a Branch of elementary Physics neglected.—Has as strong Claims as Light, Electricity, or Magnetism.—Is a universal Agent in Nature.—In Art.—In Science.—Astronomy.—Chemistry.—In every Situation of Life.—Applications of it in Clothing and artificial Warming and Cooling.—Lighting.—Admits of easy explanation.—Dilatation.—Examples.—Thermometer.—Melting and boiling Points.—Evaporation.—Specific Heat.—Heat produced by Compression.—Radiation.—Conduction.—Incandescence.

GALVANISM..... 327

Origin of the Discovery.—Galvani Professor at Bologna.—Accidental Effect on Frogs.—Ignorance of Galvani.—His Experiments on the Frog.—Accidental Discovery of the Effect of metallic Contact.—Animal Electricity.—Galvani opposed by Volta.—Volta's Theory of Contact prevails.—Fabroni's Experiments.—Invention of the Voltaic Pile.—La Couronne des Tasses.—Napoleon's Invitation to Volta.—Physiological Effects of the Pile.—Anecdote of Napoleon.—Decomposition of Water.—Cruikshank's Experiments.—Davy commences his Researches.—Effect of Chemical Action discovered.—Ritter's Secondary Pile.—Calorific Effects of the Pile.—Hypothesis of Grothius.—Davy's celebrated Bakerian Lecture.—Prize awarded him by the French Academy.—His Discovery of the Transferring Power of the Pile in chemical Action.—His Electro-Chemical Theory.—Decomposition of Potash and Soda.—New Metals, Potassium and Sodium.—Discovery of Barium.—Strontium, Calcium, and Magnesium.—Rapid Discovery of the other new Metals.—Dry Piles.

THE MOON AND THE WEATHER..... 371

Ancient Prognostics of Aristotle, Theophrastus, Aratus, Theon, Pliny, Virgil.—Recent Predictions.—Theory of Lunar Attraction not in accordance with popular Opinion.—Changes of Weather compared with Changes of the Moon.—Prevalence of Rain compared with lunar Phases.—Direction of the Wind.—Height of Barometer compared with lunar Phases.—Erroneous Notions of Cycles of nineteen and nine Years.—Cycle of four and eight Years mentioned by Pliny.

PERIODIC COMETS..... 389

Encke's Comet.—Its Period and Orbit.—How its Motion shows the Existence of a resisting Medium.—This Result corroborated by the Theory of Light.—Newton's Conjectures respecting

Comets.—Biela's Comet.—Its Period and Orbit—Lexell's Comet.—Causes of its Appearance and Disappearance.—Whiston's Comet.—His Theory.—Did this Comet produce the Deluge?—Orbit of this Comet.

RADIATION OF HEAT PAGE 403
Radiation a Property of Heat.—Prismatic Spectrum.—Invisible Rays.—Two Hypotheses.—Invisible Rays alike in their Properties to luminous Rays.—Discoveries of Leslie.—Differential Thermometer.—Radiation, Reflection, and Absorption.—Effect of Screens.—Supposed Rays of Cold.—Common Phenomenon explained.—Theory of Dew.

METEORIC STONES AND SHOOTING STARS 425
Inductive Method.—Appearances accompanying Meteorites.—Theories to explain them.—Examination of these Theories.—Shooting Stars.—November and August Meteors.—Orbits and Distances.—Heights.—Chladni's Hypothesis.

THE EARTH 443
A difficult Subject of Investigation.—Form of the Earth.—How proved globular.—Its Magnitude.—Its annual Motion.—Elliptic Form of its Orbit.—Proofs of its annual Motion from the Theory of Gravitation.—From the Motion of Light.—The Earth's diurnal Motion.—Inequalities of Day and Night.—Weight of the Earth.—Maskelyne's Experiment.—Cavendish's Experiment.—Their Accordance.—Density of the Earth.—The Seasons.—Caloric Effect of the Sun's Rays.—Why the longest is not the hottest Day.—Why the shortest Day is not the coldest.—The hottest Season takes place when the Sun is farthest from the Earth.—Proofs of the diurnal Rotation.—Spheroidal Form of the Earth proved by Theory and by Observation.

LUNAR INFLUENCES 467
The red Moon.—Supposed Effect of the Moon on the Movement of Sap in Plants.—Prejudice respecting the time for felling Timber.—Extent of this Prejudice.—Its Prevalence among Transatlantic People.—Prejudices respecting Effects on Grain.—On Wine.—On the Complexion.—On Putrefaction.—On Wounds.—On the size of Oysters and Shellfish.—On the Marrow of Animals.—On the Weight of the human Body.—On the Time of Births.—On the Hatching of Eggs.—On Human Maladies.—On Insanity.—On Fevers.—On Epidemics.—Case of Vallisneri.—Case of Bacon.—On Cutaneous Diseases, Convulsions, Paralysis, Epilepsy, &c.—Observations of Dr. Olbera.

PHYSICAL CONSTITUTION OF COMETS 479
Orbital Motion of Comets.—Their Number.—Their Light.—Explanation of this.—Theory of Herschel.—Constitution of Comets.—Nebulosity.—Nucleus.—Tail.—Comets of 1811—1680—1769—1744—1843—1844.

THUNDER-STORMS 499
The Deficiency of our present Knowledge.—Of common Thunder-Clouds.—Character and electric Charge of Clouds.—Discharge between vicinal Clouds.—Conditions for such Discharge.—Discharge between the Clouds and the Earth.—Mutual Attraction or Repulsion of electrized Clouds.—Characters of the upper and of the lower Surface of Clouds.—Negative Testimony respecting Thunder from an isolated Cloud.—Cases of Lightning from an isolated Cloud.—A fresh Case related by M. Duperrey.—Obvious Inferences from the above Cases.—Of volcanic Thunder-Clouds.—Lightning from the Ashes, Smoke, and Vapor of Volcanoes.—Theoretical Ideas of its Origin.—Of the Height of stormy Clouds.—Mode of Observation.—Ascending Flashes of Lightning.—Minor Limits of the Height of Storm-Clouds.—Inefficiency of many recorded Observations.—Table of Observations as collected by Arago.—Flash of Lightning from a Cloud upward.—Of Lightning.—Varieties of Lightning.—Zigzag Lightning.—Forked Lightning.—Deficiency in our Vocabulary of Terms.—Sheet Lightning.—Table of Instances of Ball-Lightning.—Mr. Harris's Explanation of Ball-Lightning.—On the Speed of Lightning.—Theory of Vision illustrated by a rotating Disk.—Wheatstone's Experiments.—Observations of the Velocity of Lightning.—Silent Lightning.—Heat Lightning.—Thunder-Bursts.—Of luminous Clouds.—Clouds themselves faintly luminous.—Possession of the Quality in various Degrees.—Clouds visibly luminous.—Various Observations of luminous Clouds.—Sabine's Observations.—Of Thunder.—Rolling of Thunder.—Duration and Intensity of rolling Thunder.—Violent Thunder from Ball-Lightning.—Interval between Lightning and Thunder.—A Case in which they were almost simultaneous.—Thunder without Lightning.—Noise attendant on Earthquakes.—Of the Attempts to explain the Phenomena of Thunder and Lightning.—Identity of Lightning and Electricity.—Whether ponderable Matter, or a Propagation of Undulations.—Difficulties of the undulatory Hypothesis.—Ball-Lightning and the Inferences to which it leads.—Bituminous Matter accompanying a Case of Lightning Discharge.—Explanations of silent Lightnings.—Observations of silent Lightnings.—Difficulties in the Explanation of silent Lightnings.—Arago's Suggestion for Observations.—Lightning hidden by dense Clouds.—Place of the Sound of Thunder.—Greatest Distance at which Thunder is heard.—Case of Distance beyond which it was inaudible.—Distance at which other Sounds have been heard.—Effects of Heat, Cold, Wind, &c.—On the Transmission of Sound.—Thunder heard when no Cloud was visible.—Hypothesis of the Cause of Thunder from the Creation of a Vacuum.—Contractions and Dilatations of the Air assigned as the Cause.—Pouillet's Theory of Decompositions and Recompositions.—Influence of Echo in causing the Roll.—Duration of an Echo.—Duration of the Roll of Thunder at Sea.—Dr. Robison's Explanation of the Roll.—Application of the Theory to Zigzag Lightning.—Inefficiency of the Theory.—Means of obtaining a minor Limit of the Length of a Flash.

THE LATITUDES AND LONGITUDES.....	PAGE 527
Definition of the Equator and Poles.—Northern and southern Hemispheres.—Latitude of a Place.—Parallel of Latitude.—Meridian of a Place.—Longitude of a Place.—Standard Meridian.—Methods of determining Latitude and Longitude various.—To find the Latitude.—Methods applicable in Observatories.—At Sea.—Hadley's Sextant.—To determine the Longitude.—How to find the Time of Day at Land.—At Sea.—Use of Chronometers.—Lunar Method of finding the Longitude.—Apparatus provided at Greenwich for giving the exact Time to Ships leaving the Port of London.—Method of determining Longitude by Moon-culminating Stars.	
THEORY OF COLORS.....	541
Refraction of a Ray of Light.—At plane Surfaces.—By a Prism.—The Prismatic Spectrum.—The Decomposition of Light.—Newton's Discoveries.—Colors of the Spectrum.—Brewster's Discovery of three Colors.—How three Colors can produce the Spectrum.—Colors of natural Bodies.—How they are produced.	
THE VISIBLE STARS.....	551
What occupies the Space beyond the Limits of the Solar System.—Wide Vacuity between this System and the Stars.—Indications of this observable in the Motions of the Planets.—Indications in the Motions of the Comets.—The immense Distance of the Stars proved by the Earth's annual Motion.—Observations made at Greenwich.—Bessel's Discovery of the Parallax.—The consequent Distance of the Stars.—Illustrations of the Magnitude of this Distance.—The different Orders and Magnitudes of the Stars.—How accounted for.—Why those of the lowest Magnitude are most numerous.—The real Magnitude of the Stars.—The Telescope unable to magnify them.—Dr. Wollaston's Investigations of the comparative Brightness and Magnitude of the Stars in relation to the Sun.—Their stupendous Magnitude.—Application of this to the Dog Star.	
WATERSPOUTS AND WHIRLWINDS.....	567
Character and Effects of Water-Spouts.—Difference between Water and Land-Spouts.—Land Spout at Montpellier.—Land-Spout at Esclades.—Columns of Sand on the Steppes of South America.—Meteor at Carcassonne.—Meteor at Dreux and Mantes.—Land-Spout at Ossoval.—Meteor witnessed and described by M. Peltier.—Conversion of a Storm into a Land-Spout.—M. Peltier's Tables of Water-Spouts and Land-Spouts.—Analysis of the above Tables.—Water-Spouts seen by Captain Beechey.—Experimental Illustration of the Phenomena.—Illustration of the gyratory Motion of Water Spouts.—M. Peltier's Deductions concerning Water Spouts.—Action of charged Clouds on light Bodies.—Noise attending Water and Land Spouts.—Transition from direct to gyratory Motion.—Effect of Induction on watery Surfaces.—Disappearance of Pools, &c.	

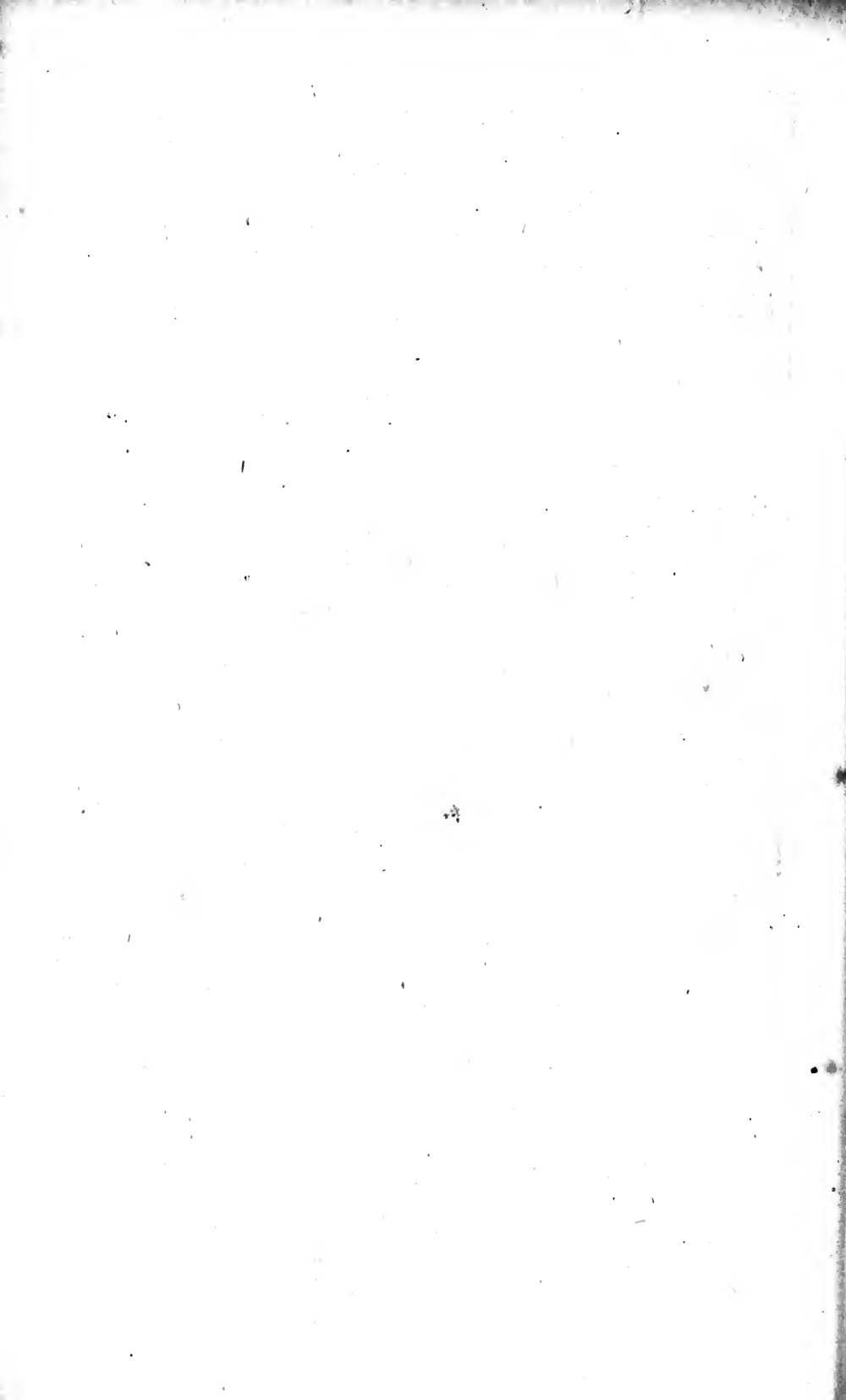

CONTENTS OF VOLUME II.

[NOTE.—For Analytical Index, see first Volume.]

MATTER AND ITS PHYSICAL PROPERTIES	PAGE 17
Divisibility.—Unlimited Divisibility.—Wollaston's Micrometric Wire.—Method of Making it.—Thickness of a Soap-Bubble.—Wings of Insects.—Gilding of Embroidery.—Globules of the Blood.—Animalcules.—Their minute Organization.—Ultimate Atoms.—Crystals.—Porosity.—Volume.—Density.—Quicksilver passing through Pores of Wood.—Filtration.—Porosity of Hydrophane.—Compressibility.—Elasticity.—Dilatability.—Heat.—Contraction of Metal used to restore the Perpendicular to Walls of a Building.—Impenetrability of Air.—Compressibility of it.—Elasticity of it.—Liquids not absolutely Incompressible.—Experiments.—Elasticity of Fluids.—Aeriform Fluids.—Domestic Fire-Box.—Evolution of Heat by compressed Air.—Inertia.—Matter incapable of spontaneous Change.—Impediments to Motion.—Motion of the Solar System.—Law of Nature.—Spontaneous Motion.—Immateriality of the thinking and willing Principles.—Language used to express Inertia sometimes faulty.—Familiar Examples of Inertia.	
ELASTICITY OF AIR	39
Exhausting Syringe.—Rate of Exhaustion.—Impossible to produce a perfect Vacuum.—Mechanical Defects.—The Air-Pump.—Barometer-Gauge.—Siphon-Gauge.—Various Forms of Air-Pump.—Pump without Suction-Valve.—Experiments with Air-Pump.—Bladder burst by atmospheric Pressure.—Bladder burst by Elasticity of Air.—Dried Fruit inflated by fixed Air.—Flaccid Bladder swells by Expansion.—Water raised by Elastic Force.—A Pump cannot act in the Absence of atmospheric Pressure.—Suction ceases when this Pressure is removed.—The Magdeburg Hemisphere.—Guinea and Feather Experiment.—Cupping.—Effervescing Liquors.—Sparkling of Champagne, &c.—Presence of Air necessary for the Transmission of Sound.—The condensing Syringe.—The Condenser.	
EFFECTS OF LIGHTNING	61
Classification of the Effects of Lightning.— <i>The sulphureous Odor revealed by Lightning</i> .—Cases collected by M. Arago.—Nature of the Odor.— <i>Chemical Changes operated by Lightning</i> .—Nitric Acid formed by the Electric Spark; also Ammonia and Nitric Acid produced during Thunder-Storms.— <i>Fusion and Contraction of Metals</i> .—Observations of the Ancients.—Franklin's cold Fusion.—Evidence against cold Fusion.—Masses of Metal melted by Lightning.— <i>Vitreifications and Fulgurites</i> .—Heights at which Vitrefactions have been found.—Facts collected by M. Arago.—Fulminary Tubes, or Fulgurites.—Characters of Fulgurites.—Variations dependent on the Nature of the Soil where they are found.—Four Hypotheses to explain their Origin.—Their Formations in some Cases are recent.—Sand fused by artificial Heat into the State of the Fulgurites.—Artificial Fulgurites formed by the Electrical Battery.—The further Condition essential to explain the Origin of Fulgurites.—Recent Formation of Fulgurites observed.— <i>Mechanical Effects</i> .—Instances of the Mechanical Action of Lightning.—The Action is exerted in all Directions.—Inductive Action of Lightning.—M. Arago's Explanation of the Effect as due to Vaporization.—Objections to the Explanation.—Decompositions of the natural Electricities of Bodies.—Induction between the Clouds and the Earth.—Upward Flashes and Mechanical Effects.—Arago's Explanation.— <i>Magnetic Effects</i> .—To be explained in ELECTRO-MAGNETISM.— <i>Effects of conducting Bodies on Lightning</i> .—Conducting Properties of Metallic Bodies.—Lightning passing along Conductors in Preference to Non-Conductors.—Protection afforded by conducting Bodies.—Lightning selects conducting Bodies from among others.—Lightning Conductors should descend to a humid Soil.—	

Necessity of Continuity in a Conductor.—*Effects proceeding from the Surface of the Earth.*—Ascent or Ebullition of Water.—Inundations from subterranean Sources.—Mosaic Account of the Deluge; Analogous natural Phenomena.—Electrical State of the Atmosphere favorable to the Process of barking Trees.—Effect of Thunder on fermented Liquors, &c.—Return Stroke reported by Brydone.—Theory of such Effects.—Flame appearing on the Ground.—Not extinguishable by Water.—Superposed Clouds not necessary to its Appearance.—Stationary luminous Appearance.—Lightning rising from the Earth like a Rocket.—Flames observed on exposed Points.—*Luminous Rain.*—Cases collected by M. Arago.—Luminous Dust.

POPULAR FALLACIES PAGE 83

Fallacious Indications of Senses.—Errors of the Sense of Feeling.—Erroneous Impressions of Heat and Cold.—Explanation of these by the Principle of Conduction.—Why a Fan is cooling.—Feats of the Fire-King explained.—Horizontal Appearance of the Sun and Moon.—Deceptive oval Disk in the Horizon.—Deceptions of Vision—of Taste—of Smelling.

PROTECTION FROM LIGHTNING 97

Danger Proportionate to the Magnitude, not to the Frequency of the Evil.—Ancient Methods of averting Lightning.—Persons in Bed not secure, as some think.—Augustus's sealkin Cloak as a Lightning Protector.—Influence of Color on the Electric Fluid.—Tiberius's Crown of Laurel as a Lightning Protector.—The Danger of taking Shelter beneath Trees.—Futility of taking Shelter in Glass Cages.—Metal about the Person destroyed by Lightning.—Metal Appendages to be laid aside.—Lightning Explosions occur at the Points where it leaves or enters a Metal.—Part of a Room which is most Safe.—Lightning more likely to discharge among a Crowd than on a single Individual.—Influence of the Vapor of Transpiration, &c.—Certain Individuals are comparative Non-Conductors.—Thunder-Clouds have been traversed with Impunity.—Thunder-Storms below the Place of Observation.—PARATONNERRES, or Lightning Conductors.—Lightning Conductors protective even when no Flash strikes them.—Sparks at the Interval where a Conductor is disjointed.—Lightning Conductors drain off the Electricity of Clouds.—Sparks or luminous Aigrettes on the Points of Conductors.—More frequent Occurrence at Sea.—Influence of Elevation of a Paratonnerre.—Experimental Illustration.—Electric Kites—Captive Balloons as Paragrèles and for Meteorological Research.—Pointed and bunt Conductors.—Quantity of Lightning drawn down by a Conductor.—Mr. Harris's Conductors for Ships.—Assumed Extent of the protecting Power of a Paratonnerre.—Not based on experimental Grounds.—Cases against its general Application.—Lightning does not always strike the highest Points.—Lightning Conductors with many Points.—A Lightning Conductor must have sufficient Capacity.—A Lightning Conductor must be in good Connexion with the moist Sub Soil.—Charcoal Beds to receive the Base of the Conductor.—Vincal metallic Conductors.—Conductors of metallic Wire-Rope; Insulation not needed.—Conductors for Powder Magazines.—Efficacy of Lightning Conductors.—Lateral or divided Discharge defined; its Cause.—More readily obtained from Conductors than from Leyden Discharges.—Line or Lines of least Resistance.—Absolute Necessity of connecting the Conductor with vicinal Bodies.—Artificial Means of producing the Electrical Odor.—Chemical Changes.—Fusion.—Fulgurites.—Mechanical Effects.—Effects of conducting Bodies.

MAGNETISM 109

Magnetic Attraction and Polarity.—Magnetic Meridian, Variation.—Dip of the Magnetic Needle.—Magnetic Attraction known to the Ancients.—Invention of the Mariner's Compass of uncertain Date.—Discovery of the Variation.—Tables of Variation constructed.—Robert Norman discovers the Dip.—Invention of the Dipping Needle.—The Variation of the Variation discovered.—Influence of Magnets on soft Iron observed.—Polarity of Magnets observed. Construction of artificial Magnets.—Magnetism imparted to Iron by the Earth.—Laws of Magnetic Attraction discovered by Coulomb.—Methods of making artificial Magnets—consequent Points.—Knight's improved Method.—Duhamel's Improvement.—Coulomb's Researches on artificial Magnets.—Influence of Heat on Magnetism.—Local and periodical Changes of the Variation.—Diurnal Variation.—Cassini's Observations at Paris.—Advancement of Magnetic Geography.—Magnetic Equator.—Magnetic Poles.

ELECTRO-MAGNETISM 117

Electro-Magnetism very recently discovered.—Oersted's Experiments at Copenhagen.—The Law according to which the Needle is deflected.—The Law of Attraction and Repulsion of Electric Currents.—Supposes Electric Currents circulating round the Globe.—Arago shows that the conducting Wire has Magnetic Properties.—Needles magnetized by the Electric Current.—The Variation of the Attraction of the Current at different Distances determined.—Laplace reduces this result to an analytical Formula.—The whole Body of Electro-Magnetic Phenomena reduced to analytical Calculation.—Faraday's Researches.—Rotation imparted to Mercury by means of the Magnet and Electric Current.—The Multiplier or Galvanometer.—Its Construction and Application.—The Earth affects Electric Currents in the same Manner as it affects Magnets.—Ampère's Theory of Terrestrial Magnetism.—Researches of M. de la Rive.—Magnetizing Power of the Current at different Distances, and the Law of its Variation.—The Effect produced by transmitting it through Metals.—The undulatory Theory of Electricity similar to that of Light.—*Thermo-Electricity*—Thermo-Electric Effects observed by Professor Seebeck.—His Experiment with Antimony and Copper.—Researches of Yelin, Marsh, and Cumming.—Oersted and Fourier construct a Thermo-Electric Pile.—Becquerel decomposes Water with such an Instrument.—Thermo-Electric Scale of Metals.

THE THERMOMETER 129

Advantages of a mercurial Thermometer.—Method of constructing one.—To purify the Mercury.—Formation of the Tube.—To fill the Tube.—Determination of the freezing and boiling Points.—

Modes of Graduation.—Alcohol Thermometers.—Difficulty of fixing the boiling Point.—Usefulness of the Thermometer.—History of its Invention.—Methods of comparing Scales of different Thermometers.

ATMOSPHERIC ELECTRICITY PAGE 147

On the Electricity of the Atmosphere in clear Weather.—Connexion between Electricity and Meteorology.—Apparatus for observing the Electricity of the Atmosphere.—Insulated elevated Rod.—Portable Apparatus made of a fishing Rod.—Saussure's Electroscope and his Mode of estimating the Value of the Divergences.—Occasional Use of the Galvanometer.—*The ordinary State of the Atmosphere.*—Volta's Theory of the Origin of Atmospheric Electricity.—Inadequacy of the Theory of Chemical Origin.—The Author's Suggestion of the probable Influence of Friction.—*Diurnal Variation of the Electricity.*—Periodical hourly Variation.—Representation of the Rate of Variation.—Maxima and Minima at a given Parallel.—Schübler's Observations.—*Annual Variation of the Electricity.*—Variation of the daily Maxima and Minima.—Arago's Repetition of Schübler's Observations.—*Local Variations of the Electricity*—Influence of particular Localities, Buildings, &c.—No satisfactory Explanation yet given of the Variations.—Correspondence between Electric and Magnetic Variations.—Becquerel's Explanation of the Phenomena of Variation.—*Distribution of Electricity of the Air.*—Negative State of the Earth.—Character of the lower Stratum of Air.—Increase of Electric Charge in the higher Strata of Air.—Decrease in the lower Strata.—Comparative Electric Character of different Strata.—Formule for the comparative Electricity of two Strata.—*Electricity of the Air in clouded Weather.*—Preliminary.—Schübler's Observations.—Table of Observations explained.

EVAPORATION 161

Erroneously ascribed to Chemical Combination.—Takes place from the Surface.—Law discovered by Dalton extended to all Liquids.—Limit of Evaporation conjectured by Faraday.—Hygrometers.—Various Phenomena explained by Evaporation.—Leslie's Method of freezing.—Examples in the useful Arts.—Methods of Cooling by Evaporation.—Dangerous Effects of Dampness.—Wollaston's Cryophorus.—Pneumatic Ink-Bottle.—Clouds.—Dew.

CONDUCTION OF HEAT 177

Conducting Powers of Bodies.—Liquids Non-Conductors.—Effect of Feathers and Wool on Animals.—Clothing.—Familiar Examples.

RELATION OF HEAT AND LIGHT 185

Probable Identity of Heat and Light.—Incandescence.—Probable Temperature of.—Gases cannot be made Incandescent.—The Absorption and Reflection of Heat depend on Color.—Burning Glass.—Heat of Sun's Rays.—Heat of artificial Light.—Moonlight.—Phosphorescence.

ACTION AND REACTION 195

Inertia in a single Body.—Consequences of Inertia in two or more Bodies.—Examples.—Effects of Impact.—Motion not estimated by Speed or Velocity alone.—Examples.—Rule for estimating the Quantity of Motion.—Action and Reaction.—Examples of.—Velocity of two Bodies after Impact.—Magnet and Iron.—Feather and Cannon-Ball impinging.—Newton's Laws of Motion.—Inutility of.

COMPOSITION AND RESOLUTION OF FORCE 205

Motion and Pressure.—Force.—Attraction.—Parallelogram of Forces.—Resultant.—Components.—Composition of Force.—Resolution of Force.—Illustrative Experiments.—Composition of Pressures.—Theorems regulating Pressures also regulate Motion.—Examples.—Resolution of Motion.—Forces in Equilibrium.—Composition of Motion and Pressure.—Illustrations.—Boat in a Current.—Motions of Fishes.—Flight of Birds.—Sails of a Vessel.—Tacking.—Equestrian Feats.—Absolute and relative Motion.

CENTRE OF GRAVITY 219

Terrestrial Attraction the combined Action of parallel Forces.—Single equivalent Force.—Examples.—Method of finding the Centre of Gravity.—Line of Direction.—Globe.—Oblate Spheroid.—Prolate Spheroid.—Cube.—Straight Wand.—Flat Plate.—Triangular Plate.—Centre of Gravity not always within the Body.—A Ring.—Experiments.—Stable, instable, and neutral Equilibrium.—Motion and Position of the Arms and Feet.—Effect of the Knee-Joint.—Positions of a Dancer.—Porter under a Load.—Motion of a Quadraped.—Rope Dancing.—Centre of Gravity of two Bodies separated from each other.—Mathematical and experimental Examples.—The Conservatism of the Motion of the Centre of Gravity.—Solar System.—Centre of Gravity sometimes called Centre of Inertia.

THE LEVER AND WHEEL-WORK 241

Simple Machine.—Statics.—Dynamics.—Force.—Power.—Weight.—The Lever.—Cord.—Inclined Plane.—Arms.—Fulcrum.—Three kinds of Lever.—Crow-Bar.—Handspike.—Oar.—Nut-Crackers.—Turning Lathe.—Steelyard.—Rectangular Lever.—Hammer.—Load between two Bearers.—Combination of Levers.—Equivalent Lever.—Wheel and Axle.—Thickness of the Rope.—Ways of applying the Power.—Projecting Pina.—Windlass.—Winch.—Axle.—Horizontal Wheel.—Tread-Mill.—Crane.—Water-Wheels.—Paddle-Wheel.—Ratchet-Wheel.—Rack.—Spring of a Watch.—Fusee.—Straps or Cords.—Examples of.—Turning Lathe.—Revolving Shafts.—Spinning Machinery.—Saw-Mill.—Pinion.—Leaves.—Crane.—Spur-Wheels.—Crown-Wheels.—Bevelled Wheels.—Huntin'-Dog.—Chronometers.—Hair-Spring.—Balance-Wheel.

THE PULLEY PAGE 269
 Cord.—Sheave.—Fixed Pulley.—Fire-Escapes.—Single moveable Pulley.—Systems of Pulleys.—Smeaton's Tackle.—White's Pulley.—Advantage of.—Runner.—Spanish Bartons.

THE INCLINED PLANE, WEDGE, AND SCREW 281
 Inclined Plane.—Effect of a Weight on.—Power of.—Roads.—Power oblique to the Plane.—Plane sometimes moves under the Weight.—Wedge.—Sometimes formed of two inclined Planes.—More powerful as its Angle is acute.—Where used.—Limits to the Angle.—Screw.—Hunter's Screw.—Examples.—Micrometer Screw.

EBULLITION 295
 Process of boiling.—Vaporization and Condensation.—Latent Heat of Steam.—Experiments of Black.—Effect of atmospheric Pressure on the boiling Point.—Ebullition under increased Pressure—under diminished Pressure.—Relation between the Barometer and boiling Point.—Effect of the Altitude of the Station of the boiling Point.—Elasticity of Steam.—Its Lightness.—Sum of the latent and sensible Heat always the same.—Effect of the Compression of Steam without Loss of Heat.—Steam cannot be liquefied by mere Pressure.—Boiling Points and latent Heat of other Liquids.—Condensation of Vapor.—Principle of the Steam-Engine.—Nature of permanent Gases.—Examples of the Application of the Properties of Steam.

COMBUSTION 319
 Flame produced by chemical Combination.—Supporters of Combustion and Combustibles.—Oxygen chief Supporter.—Heat of Combustion.—Flame.—Its illuminating Powers.—Combustion without Flame.—Property of spongy Platinum.—Table of Heat evolved in Combustion.—Theory of Lavoisier.—Of Hook and others.—Electric Theory.

HOW TO OBSERVE THE HEAVENS 329
 Interesting Nature of the Subject.—Diurnal Rotation.—Circumpolar Stars.—*Ursa Major*.—Forms of the Constellations.—The Pointers.—The Pole-Star.—*Cassiopeia*.—*Capella*.—The Swan.—Equatorial Constellations.—*Orion*.—*Sirius*, or the Dogstar.—*Aldebaran*.—*Procyon*.—*Auriga*.—*Columba*.—Herschel's Observations on *Sirius*.—Dr. Wollaston's Observations.—Aspect of the Heavens at different Seasons of the Year.—Uses of the Celestial Globe.—To Ascertain the Aspect of the Heavens on any Night—at any Hour.—Effect of the Telescope on Fixed Stars.—Relative Brightness of the Stars.—Theory of refracting and reflecting Telescopes, as applied to the Stars.—Manner in which Sir W. Herschel applied it.—Method of estimating the Brightness of small Stars.—Method of observing variable Stars.—Double Stars.—Description of the Micrometer.

THE STELLAR UNIVERSE—FIRST LECTURE 355
 Range of Vision.—Augmented by the Telescope.—*Periodic Stars*.—Examples of this Class.—Various Hypotheses to explain these Appearances.—Their Insufficiency.—*Temporary Stars*.—Remarkable Examples of this Class.—These may possibly be periodic Stars.—*Double Stars*.—Their vast Number.—They are physically connected.—Telescopic Views of them.—How they may indicate the annual Parallax.—Researches of Sir W. Herschel.—Discovery of the orbital Motions of double Stars.—Binary Stars.—Extension of Gravitation to the Stars.—Their elliptic Orbits discovered.—Effects of double and colored Suns.—*Proper Motions of the Stars*.—Probable Motion of the Solar System.—Analysis of its Effects.—Suggestion of Mr. Pond.—Independent Motions of the Stars.—*Proper Motions of double Stars*.—Probable Amount of the real Motions of the Stars.

THE STELLAR UNIVERSE—SECOND LECTURE 375
 Form and Arrangement of the Mass of visible Stars.—Sir W. Herschel's Analysis of the Heavens.—The Milky Way.—The vast Numbers of Stars in it.—Form and Dimensions of this Mass of Stars.—Nebulæ and Clusters.—Various Forms and Appearance of Nebulæ.—Great Nebula in Orion.—Megallanic Clouds.—Planetary Nebulæ.—Vast Number of Nebulæ.—Herschel's Catalogue.—Structure of the Universe.—Laplace's nebular Hypothesis.—Examination of its moral Tendency.

THE STEAM-ENGINE—FIRST LECTURE 397
 The Steam-Engine a Subject of popular Interest.—Effects of Steam.—Great Power of Steam.—Mechanical Properties of Fluids.—Elastic and inelastic Fluids.—Elasticity of Gases.—Effects of Heat.—Savery's Engine.—Boilers and their Appendages.—Working Apparatus.—Mode of Operation.—Defects of Savery's Engine.—Newcomen and Cawley's Patent.—Accidental Discovery of Condensation by Injection.—Potter's Invention of the Method of working the Valves.—His Contrivance improved by the Substitution of the Plug-Frame.

THE STEAM-ENGINE—SECOND LECTURE 417
 Mechanical Force of Steam.—Facts to be remembered.—Watt finds Condensation in the Cylinder incompatible with a due Economy of Fuel.—Conceives the Notion of Condensing out of the Cylinder.—Discovers separate Condensation.—Invents the Air-Pump.—Substitutes Steam Pressure for Atmospheric Pressure.—Invents the Steam Case or Jacket.—His first Experiments to realize these Inventions.—His Experimental Apparatus.—His Models at Delft House.—Difficulties of bringing the improved Engines into Use.—Watt employed by Roebuck.—His Partnership.—His first Patent.—His Single-Acting Engine.—Discovery of the Expansive Action of Steam.—Its Mechanical Effects.—Its Variable Action.—Methods of Equalizing it.—Its extensive Application in the Cornish Engines.—Extension of the Steam Engine to Manufactures.—Attempts of Papin, Savery, Hull, Champion, Stewart, and Washborough.—Watt's second Patent.—Sun and Planet Wheels.—Valves of Double-Acting Engine.

THE STEAM-ENGINE—THIRD LECTURE	451
Methods of Connecting the Piston-Rod and Beam in the Double-Acting Engine.—Rack and Sector.—Parallel Motion.—Connexion of Piston-Rod and Beam.—Connecting Rod and Crank.—Fly-Wheel.—Throttle-Valve.—Governor.—Construction and Operation of the Double-Acting Engine.—Eccentric.—Cocks and Valves.—Single-Clack Valves.—Double-Clack Valves.—Conical Valves.—Slide Valves.—Murray's Slides.—The D Valves.—Seaward's Slides.—Single Cock.—Two-way Cock.—Four-way Cock.—Pistons.—Common hemp packed Piston.—Woolf's Piston.—Metallic Pistons.—Cartwright's Engine.—Cartwright's Piston.—Barton's Piston.	
THE STEAM-ENGINE—FOURTH LECTURE	451
Analysis of Coal.—Process of Combustion.—Heat evolved in it.—Form and Structure of Boiler.—Wagon-Boiler.—Furnace.—Method of Feeding it.—Combustion of Gas in Flues.—Williams's Patent for Method of Consuming unburned Gases.—Construction of Grate and Ash-Pit.—Magnitude of Heating Surface of Boiler.—Steam-Space and Water-Space in Boiler.—Position of Flues.—Method of Feeding Boiler.—Method of Indicating the Level of Water in the Boiler.—Lever Gauges.—Self-Regulating Feeders.—Steam-Gauge.—Barometer-Gauge.—Watt's Invention of the Indicator.—Counter.—Safety-Valve.—Fusible Plugs.—Self-Regulating Damper.—Brunton's Self-Regulating Furnace.—Gross and Useful Effect of an Engine.—Power and Duty of Engines.—Horse-Power of Steam-Engines.—Table exhibiting the Mechanical Power of Water converted into Steam at various Pressures.—Evaporation proportional to Horse-Power.—Sources of Loss of Power.—Absence of good Practical Rules for Power.—Common Rules followed by Engine-Makers.—Duty distinguished from Power.—Duty of Boilers.—Proportion of Stroke to Diameter of Cylinder.—Duty of Engines.—Cornish System of Inspection.—Table showing the Improvement of Cornish Engines.—Beneficial Effects of Cornish Inspection.—Successive Improvements on which the increased Duty of Engines depends, traced by John Taylor in his "Records of Mining."	
THE STEAM-ENGINE—FIFTH LECTURE	525
Railways.—Effects of Railway Transport.—History of the Locomotive Engine.—Construction of Locomotive Engine by Blinkinsop.—Messrs. Chapman's Contrivance.—Walking Engine.—Mr. Stephenson's Engines at Killingworth.—Liverpool and Manchester Railway.—Experimental Trial of the "Rocket," "Sanspareil," and "Novelty."—Method of Subdividing the Flue into Tubes.—Progressive Improvement of Locomotive Engines.—Adoption of Brass Tubes.—Detailed Description of the most Improved Locomotive Engines.—Power of Locomotive Engines.—Position of the Eccentrics.—Pressure of Steam in the Boiler.—Dr. Lardner's Experiments in 1838.—Resistance to Railway Trains.—Dr. Lardner's Experiments on the Great-Western Railway.—Experiments on Resistance.—Restrictions on Gradients.—Compensating Effect of Gradients.—Experiment with the "Hecla."—Disposition of Gradients should be Uniform.—Methods of surmounting Steep Inclinations.	

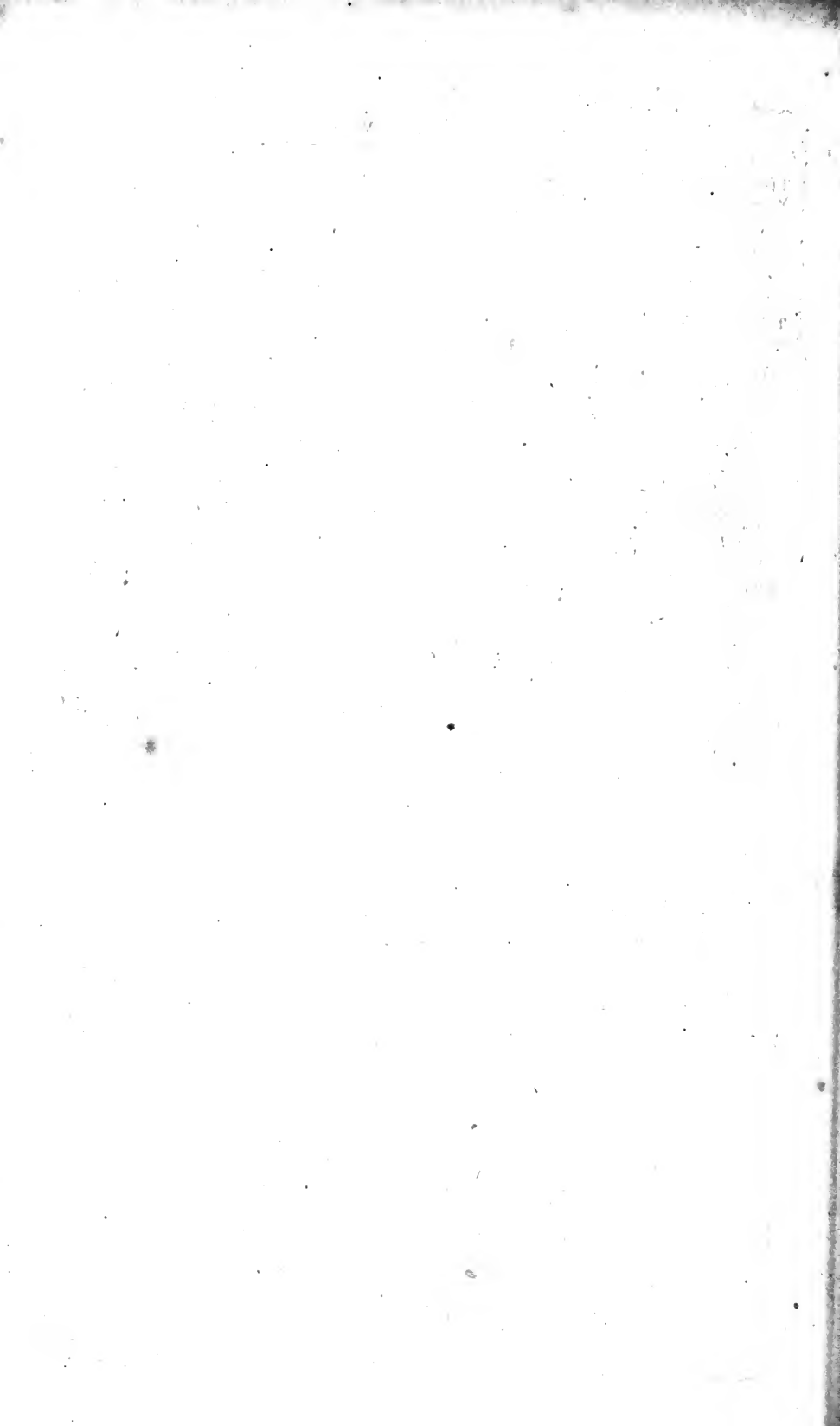

MATTER & ITS PHYSICAL PROPERTIES.

Divisibility.—Unlimited Divisibility.—Wollaston's Micrometric Wire.—Method of making it.—Thickness of a Soap-Bubble.—Wings of Insects.—Gilding of Embroidery.—Globules of the Blood.—Animalcules.—Their minute Organization.—Ultimate Atoms.—Crystals.—Porosity.—Volume.—Density.—Quicksilver passing through Pores of Wood.—Filtration.—Porosity of Hydrophane.—Compressibility.—Elasticity.—Dilatability.—Heat.—Contraction of Metal used to restore the Perpendicular to Walls of a Building.—Impenetrability of Air.—Compressibility of it.—Elasticity of it.—Liquids not absolutely Incompressible.—Experiments.—Elasticity of Fluids.—Aëri-form Fluids.—Domestic Fire Box.—Evolution of Heat by compressed Air.—Inertia.—Matter incapable of spontaneous Change.—Impediments to Motion.—Motion of the Solar System.—Law of Nature.—Spontaneous Motion.—Immateriality of the thinking and willing Principles.—Language used to express Inertia sometimes faulty.—Familiar Examples of Inertia.

1773

1773
1774
1775
1776
1777
1778
1779
1780

1773

MATTER & ITS PHYSICAL PROPERTIES.

PLACED in the material world, man is continually exposed to the action of an infinite variety of objects by which he is surrounded. The body, to which the thinking and living principles have been united, is an apparatus exquisitely contrived to receive and to transmit these impressions. Its various parts are organized with obvious reference to the several external agents by which it is to be affected. Each organ is designed to convey to the mind immediate notice of some peculiar action, and is accordingly endowed with a corresponding susceptibility. This adaptation of the organs of sense to the particular influences of material agents, is rendered still more conspicuous when we consider that, however delicate its structure, each organ is wholly insensible to every influence except that to which it appears to be specially appropriated. The eye, so intensely susceptible of impressions from light, is not at all affected by those of sound; while the fine mechanism of the ear, so sensitively alive to every effect of the latter class, is altogether insensible to the former. The splendor of excessive light may occasion blindness, and deafness may result from the roar of a cannonade; but neither the sight nor the hearing can be injured by the most extreme action of that principle which is designed to affect the other.

Thus the organs of sense are instruments by which the mind is enabled to determine the existence and the qualities of external things. The effects which these objects produce upon the mind through the organs, are called *sensations*, and these sensations are the immediate elements of all human knowledge. **MATTER** is the general name that has been given to that substance which, under forms infinitely various, affects the senses. Metaphysicians have differed in defining this principle. Some have even doubted of its existence. But these discussions are beyond the sphere of mechanical philosophy, the conclusions of which are in no wise affected by them. Our investigations here relate, not to matter as an abstract existence, but to those qualities which we discover in it by the senses, and of the existence of which we are sure, however the question as to matter itself may be decided. When

we speak of "bodies," we mean those things, whatever they be, which excite in our minds certain sensations; and the powers to excite those sensations are called "properties," or "qualities."

To ascertain, by observation, the properties of bodies, is the first step toward obtaining a knowledge of nature. Hence man becomes a natural philosopher the moment he begins to feel and to perceive. The first stage of life is a state of constant and curious excitement. Observation and attention, ever awake, are engaged upon a succession of objects new and wonderful. The large repository of the memory is opened, and every hour pours into it unbounded stores of natural facts and appearances, the rich materials of future knowledge. The keen appetite for discovery, implanted in the mind for the highest ends, continually stimulated by the presence of what is novel, renders torpid every other faculty, and the powers of reflection and comparison are lost in the incessant activity and unexhausted vigor of observation. After a season, however, the more ordinary classes of phenomena cease to excite by their novelty. Attention is drawn from the discovery of what is new, to the examination of what is familiar. From the external world the mind turns in upon itself, and the feverish astonishment of childhood gives place to the more calm contemplation of incipient maturity. The vast and heterogeneous mass of phenomena collected by past experience is brought under review. The great work of comparison begins. Memory produces her stores, and reason arranges them. Then succeed those first attempts at generalization which mark the dawn of science in the mind.

To compare, to classify, to generalize, seem to be instinctive propensities peculiar to man. They separate him from inferior animals by a wide chasm. It is to these powers that all the higher mental attributes may be traced, and it is from their right application that all progress in science must arise. Without these powers, the phenomena of nature would continue a confused heap of crude facts, with which the memory might be loaded, but from which the intellect would derive no advantage. Comparison and generalization are the great digestive organs of the mind, by which only nutrition can be extracted from this mass of intellectual food, and without which, observation the most extensive, and attention the most unremitting, can be productive of no real or useful advancement in knowledge.

Upon reviewing those properties of bodies which the senses most frequently present to us, we observe that very few of them are essential to, and inseparable from, matter. The greater number may be called *particular* or *peculiar qualities*, being found in some bodies, but not in others. Thus the property of attracting iron is peculiar to the loadstone, and not observable in other substances. One body excites the sensation of green, another of red, and a third is deprived of all color. A few characteristic and essential qualities are, however, inseparable from matter in whatever state or under whatever form it exist. Such properties alone can be considered as tests of materiality. Where their presence is neither manifest to sense, nor demonstrable by reason, *there* matter is not. The principal of these qualities are *magnitude* and *impenetrability*.

MAGNITUDE.

Every body occupies space; that is, it has magnitude. This is a property observable by the senses in all bodies which are not so minute as to elude them, and which the understanding can trace to the smallest particle of matter. It is impossible, by any stretch of imagination, even to conceive a portion of matter so minute as to have no magnitude.

The quantity of space which a body occupies is sometimes called its magnitude. In colloquial phraseology, the word size is used to express this notion: but the most correct term, and that which we shall generally adopt, is volume. Thus we say, the volume of the earth is so many cubic miles, the volume of this room is so many cubic feet.

The external limits of the magnitude of a body are lines and surfaces, lines being the limits which separate the several surfaces of the same body. The linear limits of a body are also called edges. Thus the line which separates the top of a chest from one of its sides is called an edge.

The quantity of a surface is called its area, and the quantity of a line is called its length. Thus we say, the area of a field is so many acres, the length of a rope is so many yards. The word "magnitude" is, however, often used indifferently for volume, area, and length. If the objects of investigation were of a more complex and subtle character, as in metaphysics, this unsteady application of terms might be productive of confusion, and even of error; but in this science, the meaning of the term is evident, from the way in which it is applied, and no inconvenience is found to arise.

IMPENETRABILITY.

This property will be most clearly explained by defining the positive quality from which it takes its name, and of which it merely signifies the absence. A substance would be penetrable if it were such as to allow another to pass through the space which it occupies, without disturbing its component parts. Thus, if a comet, striking the earth, could enter it at one side, and, passing through it, emerge from the other without separating or deranging any bodies on or within the earth, then the earth would be penetrable by the comet. When bodies are said to be impenetrable, it is therefore meant that one cannot pass through another without displacing some or all of the component parts of that other. There are many instances of apparent penetration; but in all these the parts of the body which seem to be penetrated are displaced. Thus, if the point of a needle be plunged in a vessel of water, all the water which previously filled the space into which the needle enters will be displaced, and the level of the water will rise in the vessel to the same height as it would by pouring in so much more water as would fill the space occupied by the needle.

FIGURE.

If the hand be placed upon a solid body, we become sensible of its impenetrability, by the obstruction which it opposes to the entrance of the hand within its dimensions. We are also sensible that this obstruction commences at certain places; that it has certain determinate limits; that these limitations are placed in certain directions relatively to each other. The mutual relation which is found to subsist between these boundaries of a body, gives us the notion of its figure. The figure and volume of a body should be carefully distinguished. Each is entirely independent of the other. Bodies having very different volumes may have the same figure; and in like manner bodies differing in figure may have the same volume. The figure of a body is what in popular language is called its shape or form. The volume of a body is that which is commonly called its size. It will hence be easily understood that one body (a globe, for example) may have ten times the volume of another (globe), and yet have the same figure; and that two bodies (as a die and a globe) may have figures altogether different, and yet have equal volumes. What we have here observed of volumes will also be applicable to lengths and areas. The arc of a circle

and a straight line may have the same length, although they have different figures; and, on the other hand, two arcs of different circles may have the same figure, but very unequal lengths. The surface of a ball is curved, that of the table plane; and yet the area of the surface of the ball may be equal to that of the table.

ATOMS—MOLECULES.

Impenetrability must not be confounded with inseparability. Every body which has been brought under human observation is separable into parts; and these parts, however small, are separable into others still more minute. To this process of division no practical limit has ever been found. Nevertheless, many of the phenomena which the researches of those who have successfully examined the laws of nature have developed, render it highly probable that all bodies are composed of elementary parts which are indivisible and unalterable. The component parts, which may be called atoms, are so minute as altogether to elude the senses, even when improved by the most powerful aids of art. The word molecule is often used to signify component parts of a body so small as to escape sensible observation, but not ultimate atoms, each molecule being supposed to be formed of several atoms, arranged according to some determinate figure. Particle is used also to express small component parts, but more generally is applied to those which are not too minute to be discoverable by observation.

FORCE.

If the particles of matter were endued with no property in relation to one another, except their mutual impenetrability, the universe would be like a mass of sand, without variety of state or form. Atoms, when placed in juxtaposition, would neither cohere, as in solid bodies; nor repel each other, as in aeriform substances. We find, on the other hand, that, in some cases, the atoms which compose bodies are not simply placed together, but a certain effect is manifested in their strong coherence. If they were merely placed in juxtaposition, their separation would be effected as easily as any component particle could be removed from one place to another. Take a piece of iron, and attempt to separate its parts: the effort will be strongly resisted, and it will be a matter of much greater facility to remove the whole mass. It appears, therefore, that in such cases the parts which are in juxtaposition *cohere*, and resist their mutual separation. This effect is denominated force; and the constituent atoms are said to cohere with a greater or less degree of force, according as they oppose a greater or less resistance to their mutual separation.

The coherence of particles in juxtaposition is an effect of the same class as the mutual approach of particles placed at a distance from each other. It is not difficult to perceive that the same influence which causes the bodies A and B to approach each other, when placed at some distance asunder, will, when they unite, retain them together, and oppose a resistance to their separation. Hence this effect of the mutual approximation of bodies toward each other is also called force.

Force is generally defined to be "whatever produces or opposes the production of motion in matter." In this sense, it is a name for the unknown cause of a known effect. It would, however, be more philosophical to give the name, not to the *cause*, of which we are ignorant, but to the *effect*, of which we have sensible evidence. To observe and to classify is the whole business of the natural philosopher. When *causes* are referred to, it is implied that effects of

the same class arise from the agency of the same cause. However probable this assumption may be, it is altogether unnecessary. All the objects of science, the enlargement of mind, the extension and improvement of knowledge, the facility of its acquisition, are obtained by generalization alone, and no good can arise from tainting our conclusions with the possible errors of hypotheses.

It may be here, once for all, observed, that the phraseology of causation and hypotheses has become so interwoven with the language of science, that it is impossible to avoid the frequent use of it. Thus we say, "The magnet *attracts* iron:" the expression *attract* intimating the cause of the observed effect. In such cases, however, we must be understood to mean the *effect itself*, finding it less inconvenient to continue the use of the received phrases, modifying their signification, than to introduce new ones.

Force, when manifested by the mutual approach or cohesion of bodies, is also called attraction, and it is variously denominated, according to the circumstances under which it is observed to act. Thus the force which holds together the atoms of solid bodies is called cohesive attraction. The force which draws bodies to the surface of the earth, when placed above it, is called the attraction of gravitation. The force which is exhibited by the mutual approach or adhesion of the loadstone and iron, is called magnetic attraction, and so on.

When force is manifested by the remotion of bodies from each other, it is called repulsion. Thus, if a piece of glass, having been briskly rubbed with a silk handkerchief, touch, successively, two feathers, these feathers, if brought near each other, will move asunder. This effect is called repulsion, and the feathers are said to repel each other.

The influence which forces have upon the form, state, arrangement, and motions, of material substances, is the principal object of physical science. In its strict sense, MECHANICS is a term of very extensive signification. According to the more popular usage, however, it has been generally applied to that part of physical science which includes the investigation of the phenomena of motion and rest, pressure, and other effects developed by the mutual action of solid masses. The consideration of similar phenomena, exhibited in bodies of the liquid form, is consigned to HYDROSTATICS, and that of aeriform fluids to PNEUMATICS.

DIVISIBILITY.

Observation and experience prove that all bodies of sensible magnitude, even the most solid, consist of parts which are separable. To the practical subdivision of matter there seems to be no assignable limit. Numerous examples of the division of matter, to a degree almost exceeding belief, may be found in experimental inquiries instituted in physical science; the useful arts furnish many instances not less striking; but perhaps the most conspicuous proofs which can be produced, of the extreme minuteness of which the parts of matter are susceptible, arise from the consideration of certain parts of the organized world.

The relative places of stars in the heavens, as seen in the field of view of a telescope, are marked by fine lines of wire placed before the eyeglass, and which cross each other at right angles. The stars appearing in the telescope as mere lucid points without sensible magnitude, it is necessary that the wires which mark their places should have a corresponding tenuity. But these wires, being magnified by the eyeglass, would have an apparent thickness, which would render them inapplicable to this purpose, unless their real dimensions were of a most uncommon degree of minuteness. To obtain wire for this purpose, Dr. Wollaston invented the following process: A piece of fine

platinum wire is extended along the axis of a cylindrical mould. Into this mould, molten silver is poured. Since the heat necessary for the fusion of platinum is much greater than that which retains silver in the liquid form, the platinum wire remains solid, while the mould is filled with the silver. When the metal has become solid by being cooled, and has been removed from the mould, a cylindrical bar of silver is obtained, having a platinum wire in its axis. This bar is then wiredrawn, by forcing it successively through holes diminishing in magnitude, the first hole being a little less than the wire at the beginning of the process. By these means, the platinum is wiredrawn at the same time and in the same proportion with the silver; so that whatever be the original proportion of the thickness of the platinum wire to that of the mould, the same will be the proportion of the platinum wire to all the successive thicknesses to which it is reduced. If we suppose the mould to be ten times the thickness of the platinum wire, then the silver wire throughout the whole process will be ten times the thickness of the platinum wire which it includes within it: The silver wire may be drawn to a thickness not exceeding the three hundredth of an inch. The platinum will thus not exceed the three thousandth of an inch.

It now remains to disengage this fine filament of platinum from the surrounding silver. For this purpose, the wire is bent into the form of a loop, as represented in the figure, with hooks at A B for suspending it. The part C D E



is now immersed in nitric acid, by which the silver is dissolved, and the platinum remains suspended in a thread so fine as to be invisible without the aid of the microscope.

By this method, Dr. Wollaston succeeded in obtaining wire the diameter of which did not exceed the eighteen thousandth of an inch. A quantity of this wire, equal in bulk to a common die used in games of chance, would extend from New York to New Orleans.

Newton succeeded in determining the thickness of very thin laminae of transparent substances by observing the colors which they reflect. A soap-bubble is a thin shell of water, and is observed to reflect different colors from different parts of its surface. Immediately before the bubble bursts, a black spot may be observed near the top. At this part the thickness has been proved not to exceed the two million five hundred thousandth of an inch.

The transparent wings of certain insects are so attenuated in their structure, that fifty thousand of them placed over each other would not form a pile a quarter of an inch in height.

In the manufacture of embroidery it is necessary to obtain very fine gilt silver threads. To accomplish this, a cylindrical bar of silver, weighing three hundred and sixty ounces, is covered with about two ounces of gold. This gilt

bar is then wiredrawn, as in the first example, until it is reduced to a thread so fine that thirty-four hundred feet of it weigh less than an ounce. The wire is then flattened, by passing it between rollers under a severe pressure, a process which increases its length, so that about four thousand feet shall weigh one ounce. Hence one foot will weigh the four thousandth part of an ounce. The proportion of the gold to the silver in the original bar was that of two to three hundred and sixty, or one to one hundred and eighty. Since the same proportion is preserved after the bar has been wiredrawn, it follows that the quantity of gold which covers one foot of the fine wire is the one hundred and eightieth part of the four thousandth of an ounce: that is the seven hundred and twenty thousandth part of an ounce.

The quantity of gold which covers one inch of the wire will be twelve times less than that which covers one foot. Hence this quantity will be the eight million six hundred and forty thousandth part of an inch. If this inch be again divided into one hundred equal parts, every part will be distinctly visible without the aid of microscopes. The gold which covers this small but visible portion is the eight hundred and sixty-four millionth part of an ounce.

But we may proceed even further. This portion of the wire may be viewed by a microscope which magnifies five hundred times, so that the five hundredth part of it will thus become visible. In this manner, therefore, an ounce of gold may be divided into four hundred and thirty-two thousand million parts. Each of these parts will possess all the characters and qualities which are found in the largest masses of the metal. It retains its solidity, texture, and color; it resists the same agents, and enters into combination with the same substances. If the gilt wire be dipped in nitric acid, the silver within the coating will be dissolved, but the hollow tube of gold which surrounded it will still cohere and remain suspended.

The organized world offers still more remarkable examples of the inconceivable subtlety of matter.

The blood which flows in the veins of animals is not, as it seems to be, a uniformly red liquid. It consists of small red globules, floating in a transparent fluid called serum. In different species these globules differ both in figure and in magnitude. In man, and all animals which suckle their young, they are perfectly round or spherical; in birds and fishes, they are of an oblong spheroidal form. In the human species, the diameter of the globules is about the four thousandth part of an inch. Hence it follows that in a drop of blood which would remain suspended from the point of a fine needle, there must be about a million of globules.

Small as these globules are, the animal kingdom presents beings whose whole bodies are still more minute. Animalcules have been discovered, whose magnitude is such, that a million of them do not exceed the bulk of a grain of sand, and yet each of these creatures is composed of members as curiously organized as those of the largest species; they have life and spontaneous motion, and are endued with sense and instinct. In the liquids in which they live, they are observed to move with astonishing speed and activity; nor are their motions blind or fortuitous, but evidently governed by choice and direction to an end. They use food and drink, from which they derive nutrition, and are therefore furnished with a digestive apparatus. They have great muscular power, and are furnished with limbs and members of strength and flexibility. They are susceptible of the same appetites, and obnoxious to the same passions, the gratification of which is attended with the same results as in our own species. Spallanzani observes that certain animalcules devour others so voraciously that they fatten, and become indolent and sluggish, by over-feeding.

After a meal of this kind, if they be confined in distilled water, so as to be

deprived of all food, their condition becomes reduced ; they regain their spirit and activity, and amuse themselves in the pursuit of the more minute animals which are supplied to them ; they swallow these without depriving them of life, for, by the aid of the microscope, the one has been observed moving within the body of the other. These singular appearances are not matters of idle and curious observation. They lead us to inquire what parts are necessary to produce such results. Must we not conclude that these creatures have heart, arteries, veins, muscles, sinews, tendons, nerves, circulating fluids, and all the concomitant apparatus of a living organized body ? And if so, how inconceivably minute must not those parts be ! If a globule of their blood bears the same proportion to their whole bulk as a globule of our blood bears to our magnitude, what powers of calculation can give an adequate notion of its minuteness ?

These and many other phenomena observed in the immediate productions of nature, or developed by mechanical and chemical processes, prove that the materials of which bodies are formed are susceptible of minuteness which infinitely exceeds the powers of sensible observation, even when those powers have been extended by all the aids of science. Shall we, then, conclude that matter is infinitely divisible, and that there are no original constituent atoms of determinate magnitude and figure at which all subdivision must cease ? Such an inference would be unwarranted, even had we no other means of judging the question except those of direct observation ; for it would be imposing that limit on the works of nature which she has placed upon our powers of observing them. Aided by reason, however, and a due consideration of certain phenomena which come within our immediate powers of observation, we are frequently able to determine other phenomena which are beyond those powers. The diurnal motion of the earth is not perceived by us, because all things around us participate in it, preserve their relative position, and appear to be at rest. But reason tells us that such a motion must produce the alternations of day and night, and the rising and setting of all the heavenly bodies—appearances which are plainly observable, and which betray the cause from which they arise. Again, we cannot place ourselves at a distance from the earth, and behold the axis on which it revolves, and observe its peculiar obliquity to the orbit in which the earth moves ; but we see and feel the vicissitudes of the seasons, an effect which is the immediate consequence of that inclination, and by which we are able to detect it.

So it is in the present case. Although we are unable by direct observation to prove the existence of constituent material atoms of determinate figure, yet there are many observable phenomena which render their existence in the highest degree probable, if not morally certain. The most remarkable of this class of effects is observed in the crystallization of salts. When salt is dissolved in a sufficient quantity of pure water, it mixes with the water in such a manner as wholly to disappear to the sight and touch, the mixture being one uniform transparent liquid like the water itself before its union with the salt. The presence of the salt in the water may, however, be ascertained by weighing the mixture, which will be found to exceed the original weight of the water by the exact amount of the weight of the salt. It is a well-known fact that a certain degree of heat will convert water into vapor, and that the same degree of heat does not effect any change in the form of salt. The mixture of salt and water being exposed to this temperature, the water will gradually evaporate, disengaging itself from the salt with which it has been combined. When so much of the water has evaporated that what remains is insufficient to keep in solution the whole of the salt, a part of it thus disengaged from the water will return to the solid state. The saline particles will not in this case collect in irregular solid molecules, but will exhibit themselves in regular fig-

ures, terminated by plane surfaces, the figures being always the same for the same species of salt, but different for different species. There are several circumstances in the formation of these crystals which merit attention.

If one of the crystals be detached from the others, and the process of its formation observed, it will be found gradually to increase, always preserving its original figure. Since its increase must be caused by the continued accession of saline particles disengaged by the evaporation of the water, it follows that these particles must be so formed, that, by attaching themselves successively to the crystal, they maintain the regularity of its bounding planes, and preserve their mutual inclinations unvaried.

Suppose a crystal to be taken from the liquid during the progress of crystallization, and a piece broken from it so as to destroy the regularity of its form; if the crystal thus broken be restored to the liquid, it will be observed gradually to resume its regular form, the atoms of salt successively dismissed by the vaporizing water filling up the irregular cavities produced by the fracture. Hence it follows that the saline particles which compose the surface of the crystal, and those which form the interior of its mass, are similar, and exert similar attractions on the atoms disengaged by the water.

All these details of the process of crystallization are very evident indications of a determinate figure in the ultimate atoms of the substances which are crystallized. But besides the substances which are thus reduced by art to the form of crystals, there are larger classes which naturally exist in that state. There are certain planes, called *planes of cleavage*, in the directions of which natural crystals are easily divided. These planes, in substances of the same kind, always have the same relative position, but differ in different substances. The surfaces of the planes of cleavage are quite invisible before the crystal is divided; but when the parts are separated, these surfaces exhibit a most intense polish, which no effort of art can equal.

We may conceive crystallized substances to be regular mechanical structures formed of atoms of a certain figure, on which the figure of the whole structure must depend. The planes of cleavage are parallel to the sides of the constituent atoms, and their directions therefore form so many conditions for the determination of its figure. The shape of the atoms being thus determined, it is not difficult to assign all the various ways in which they may have been arranged, so as to produce figures which are accordingly found to correspond with the various forms of crystals of the same substance.

When these phenomena are duly considered and compared, little doubt can remain that all substances susceptible of crystallization consist of atoms of determinate figure. This is the case with all solid bodies whatever which have come under scientific observation, for they have been severally found in, or reduced to, a crystallized form. Liquids crystallize in freezing; and if aeriform fluids could by any means be reduced to the solid form, they would probably also manifest the same effect. Hence it appears reasonable to presume that all bodies are composed of atoms; that the different qualities with which we find different substances endued, depend on the magnitude and figure of these atoms; and these atoms are indestructible and immutable by any natural process, for we find the qualities which depend on them unchangeably the same under all the influences to which they have been submitted since their creation; that these atoms are so minute in their magnitude, that they cannot be observed by any means which human art has yet contrived, but still that there are limits of magnitude which they do not exceed.

It is proper, however, to observe here, that the various theories of mechanical science do not rest upon any hypotheses concerning these atoms as a basis. They are not inferred from this or any other supposition, and therefore their

truth would not be in anywise disturbed, even though it should be established that matter is physically divisible *ad infinitum*. The basis of mechanical science is *observed facts*; and since the reasoning is demonstrative, the conclusions have the same degree of certainty as the facts from which they are deduced.

POROSITY.

The *volume* of a body is the quantity of space included within its external surface. The *mass* of a body is the collection of atoms or material particles of which it consists. Two atoms or particles are said to be in contact, when they have approached each other until arrested by their mutual impenetrability. If the component particles of a body were in contact, the *volume* would be completely occupied by the mass. But this is not the case. We shall presently prove that the component particles of no known substance are in absolute contact. Hence it follows that the volume consists partly of material particles and partly of interstitial spaces, which spaces are either absolutely void and empty or filled by some substance of a different species from the body in question. These interstitial spaces are called *pores*.

In bodies which are constituted uniformly throughout their entire dimensions, the component particles and the pores are uniformly distributed through the volume; that is, a given space in one part of the volume will contain the same quantity of matter and the same quantity of pores as an equal space in another part.

The proportion of the quantity of matter to the magnitude is called the *density*. Thus, if of two substances, one contains in a given space twice as much matter as the other, it is said to be "twice as dense." The density of bodies is therefore proportionate to the closeness or proximity of their particles, and it is evident that the greater the density, the less will be the porosity.

The pores of a body are frequently filled with another body of a more subtle nature. If the pores of a body on the surface of the earth, and exposed to the atmosphere, be greater than the particles of air, then the air will pervade the pores. This is found to be the case of many sorts of wood which have open grains. If a piece of such wood, or of chalk, or of sugar, be pressed to the bottom of a vessel of water, the air which fills the pores will be observed to escape in bubbles, and to rise to the surface, the water pervading the pores and taking its place.

If a tall vessel or tube, having a wooden bottom, be filled with quicksilver, the liquid metal will be forced by its own weight through the pores of the wood, and will be seen escaping in a silver shower from the bottom.

The process of filtration in the arts depends on the presence of pores of such a magnitude as to allow a passage to the liquid, but to refuse it to those impurities from which it is to be disengaged. Various substances are used as filters; but whatever be used, this circumstance should always be remembered, that no substance can be separated from a liquid by filtration except one whose particles are larger than those of the liquid. In general, filters are used to separate *solid* impurities from a liquid. The most ordinary filters are soft-stone paper and charcoal.

All organized substances in the animal and vegetable kingdoms are, from their very nature, porous in a high degree. Minerals are porous in various degrees. Among the silicious stones is one called *hydropbane*, which manifests its porosity in a very remarkable manner. The stone in its ordinary state is semi-transparent. If, however, it be plunged in water, when it is withdrawn it is as translucent as glass. The pores in this case previously filled

with air, are pervaded by the water, between which and the stone there subsists a physical relation by which the one renders the other perfectly transparent.

Larger mineral masses exhibit degrees of porosity not less striking. Water percolates through the sides and roofs of caverns and grottoes; and being impregnated with calcareous and other earths, forms stalactites or pendent protuberances, which present a curious appearance.

COMPRESSIBILITY.

That quality in virtue of which a body allows its volume to be diminished without diminishing its mass, is called *compressibility*. This effect is produced by bringing the constituent particles more closely together, and thereby increasing the density and diminishing the pores. This effect may be produced in several ways, but the name compressibility is applied to it when it is caused by the agency of mechanical force, as by pressure or percussion. All known bodies, whatever be their nature, are capable of having their dimensions reduced without diminishing their mass, and this is one of the most conclusive proofs that all bodies are porous, or that the constituent atoms are not in contact; for the space by which the volume may be diminished, must, before the diminution, consist of pores. Some bodies, when compressed by the agency of mechanical force, will resume their former dimensions with a certain force when relieved from the operation of the force which has compressed them. This property is called *elasticity*, and it follows from this definition that all elastic bodies must be compressible, although the converse is not true compressibility—not necessarily implying elasticity.

DILATABILITY.

This quality is the opposite of compressibility. It is the capability observed in bodies to have their volume enlarged without increasing their mass. This effect may be produced in several ways. In ordinary circumstances, a body may exist under the constant action of a pressure by which its volume and density are determined. It may happen that on the occasional removal of that pressure the body will *dilate*, by a quality inherent in its constitution. This is the case with common air. Dilatation may also be the effect of heat, as will presently appear. The several qualities of bodies which we have noticed in this chapter, when viewed in relation to each other, present many circumstances worthy of attention. It is a physical law, to which there is no *real* exception, that an increase in the temperature or degree of heat by which a body is affected, is accompanied by an increase of volume, and that a diminution of temperature is accompanied by a diminution of volume. The apparent exceptions to this law will be noticed and explained in our discourses on *heat*. Hence it appears that the reduction of temperature is an effect which, considered mechanically, is equivalent to compression or condensation, since it diminishes the volume without altering the mass; and since this is an effect of which all bodies whatever are susceptible, it follows that all bodies whatever have *pores*.

The fact that the elevation of temperature produces an increase of volume, is manifested by numerous experiments.

If a flaccid bladder be tied at the mouth so as to stop the passage of air, and be then held before a fire, it will gradually swell and assume the appearance of being fully inflated. The small quantity of air contained in the bladder is,

in this case, so much dilated by the heat, that it occupies a considerably increased space, and fills the bladder, of which it before only occupied a small part. When the bladder is removed from the fire, and allowed to resume its former temperature, the air returns to its former dimensions, and the bladder becomes again flaccid.

Let a glass tube, with the bulb at the end, have the bulb and a part of the tube filled with any liquid, colored so as to be visible. If the bulb be exposed to heat, by being plunged in hot water, the level of the liquid will rapidly rise. This effect is produced by the dilatation of the liquid in the bulb, which, filling a greater space, a part of it is forced into the tube. This experiment may easily be made with a common glass tube and a little port wine.

Thermometers are constructed on this principle, the ascent of the liquid in the tube being used as an indication of the degree of heat which causes it. A particular account of these useful instruments will be found in our discourse on them.

The change of dimensions of solids produced by changes of temperature being much less than that of bodies in the liquid or aeriform state, is not so easily observable. A remarkable instance occurs in the process of shoeing the wheels of carriages. The rim of iron with which the wheel is to be bound is made in the first instance of a diameter somewhat less than that of the wheel; but being raised by the application of fire to a very high temperature, its volume receives such an increase, that it will be sufficient to embrace and surround the wheel. When placed upon the wheel, it is cooled, and suddenly contracting its dimensions, binds the parts of the wheel firmly together, and becomes securely seated in its place upon the face of the felloes.

It frequently happens that the stopper of a glass bottle or decanter becomes fixed in its place so firmly, that the exertion of force sufficient to withdraw it would endanger the vessel. In this case, if a cloth wetted with hot water be applied to the neck of the bottle, the glass will expand, and the neck will be enlarged so as to allow the stopper to be easily withdrawn.

The contraction of metal consequent upon change of temperature has been applied some time ago in Paris to restore the walls of a tottering building to their proper position. In the *Conservatoire des Arts et M^{ét}iers*, the walls of a part of the building were forced out of the perpendicular by the weight of the roof, so that each wall was leaning outward. M. Molard conceived the notion of applying the irresistible force with which metals contract in cooling, to draw the walls together. Bars of iron were placed in parallel directions across the building, and at right angles to the direction of the walls. Being passed through the walls, nuts were screwed on their ends outside the building. Every alternate bar was then heated by lamps, and the nuts screwed close to the walls. The bars were then cooled, and the lengths being diminished by contraction, the nuts on their extremities were drawn together, and with them the walls were drawn through an equal space. The same process was repeated with the intermediate bars, and so on alternately, until the walls were brought into a perpendicular position.

Since there is a continual change of temperature in all bodies on the surface of the globe, it follows that there is also a continual change of magnitude. The substances which surround us are constantly swelling and contracting under the vicissitudes of heat and cold. They grow smaller in winter, and dilate in summer; they swell their bulk in a warm day, and contract it in a cold one. These curious phenomena are not noticed, only because our ordinary means of observation are not sufficiently accurate to appreciate them. Nevertheless, in some instances, the effect is very obvious. In warm weather, the flesh swells, the vessels appear filled, the hand is plump, and the skin distended. In cold

weather, when the body has been exposed to the open air, the flesh appears to contract, the vessels shrink, and the skin shrivels.

The phenomena attending change of temperature are conclusive proofs of the universal porosity of material substances, but they are not the only proofs. Many substances admit of compression by the mere agency of mechanical force. Let a small piece of cork be placed floating on the surface of water in a basin or other vessel, and an empty glass goblet be inverted over the cork so that its edge just meets the water. A portion of air will then be confined in the goblet and detached from the remainder of the atmosphere. If the goblet be now pressed downward so as to be entirely immersed, it will be observed that the water will not fill it, being excluded by the *impenetrability* of the air enclosed in it. This experiment, therefore, is decisive of the fact that air, one of the most subtle and attenuated substances we know of, possesses the quality of impenetrability. It absolutely excludes every other body from the space which it occupies at any given moment.

But although the water does not fill the goblet, yet if the position of the cork which floats upon its surface be noticed, it will be found that the level of the water within has risen above its edge or rim. In fact, the water has partially filled the goblet, and the air has been forced to contract its dimensions. This effect is produced by the pressure of the incumbent water forcing the surface in the goblet against the air, which yields until it is so far compressed that it acquires a force able to withstand this pressure. Thus it appears that air is capable of being reduced in its dimensions by mechanical pressure, independently of the agency of heat. It is *compressible*.

That this effect is the consequence of the pressure of the liquid, will be easily made manifest by showing that, as the pressure is increased, the air is proportionally contracted in its dimensions; and as it is diminished, the dimensions are, on the other hand, enlarged. If the depth of the goblet in the water be increased, the cork will be seen to rise in it, showing that the increased pressure at the greater depth causes the air in the goblet to be more condensed. If, on the other hand, the goblet be raised toward the surface, the cork will be observed to descend toward the edge, showing that as it is relieved from the pressure of the liquid, the air gradually approaches to its primitive dimensions.

These phenomena also prove that air has the property of *elasticity*. If it were simply compressible, and not elastic, it would retain the dimensions to which it was reduced by the pressure of the liquid; but this is not found to be the result. As the compressing force is diminished, so in the same proportion does the air, by its elastic virtue, exert a force by which it resumes its former dimensions.

That it is the air alone which excludes the water from the goblet in the preceding experiments, can easily be proved. When the goblet is sunk deep in the vessel of water, let it be inclined a little to one side until its mouth is presented toward the side of the vessel; let this inclination be so regulated that the surface of the water in the goblet shall just reach its edge. Upon a slight increase of inclination, air will be observed to escape from the goblet, and to rise in bubbles to the surface of the water. If the goblet be then restored to its position, it will be found that the cork will rise higher in it than before the escape of the air. The water in this case rises and fills the space which the air, allowed to escape, has deserted. The same process may be repeated until all the air has escaped, and then the goblet will be completely filled by the water.

Liquids are compressible by mechanical force in so slight a degree, that they are considered in all hydrostatical treatises as incompressible fluids. They

are, however, not absolutely incompressible, but yield slightly to very intense pressure.

The question of the compressibility of liquids was raised at a remote period in the history of science. Nearly two centuries ago an experiment was instituted at the *Academy del Cimento* in Florence, to ascertain whether water be compressible. With this view, a hollow ball of gold was filled with the liquid, and the aperture exactly and firmly closed. The globe was then submitted to a very severe pressure, by which its figure was slightly changed. Now, it is proved in geometry that a globe has this peculiar property, that any change whatever in its figure must necessarily diminish its volume or contents. Hence it was inferred that if the water did not issue through the pores of the gold, or burst the globe, its compressibility would be established. The result of the experiment was that the water *did* ooze through the pores, and covered the surface of the globe, presenting the appearance of dew or of steam cooled by the metal. But this experiment was inconclusive. It is quite true that if the water *had not* escaped, upon the change of figure of the globe, the *compressibility* of the liquid would have been established. This escape of the water does not, however, prove its *incompressibility*. To accomplish this, it would be necessary first to measure accurately the volume of water which transuded by compression, and next to measure the diminution of volume which the vessel suffered by its change of figure. If this diminution were greater than the volume of water which escaped, it would follow that the water remaining in the globe had been compressed, notwithstanding the escape of the remainder. But this could never be accomplished with the delicacy and exactitude necessary in such an experiment, and consequently, as far as the question of the compressibility of water was concerned, nothing was proved. It forms, however, a very striking illustration of the porosity of so dense a substance as gold, and proves that its pores are larger than the elementary particles of water, since they are capable of passing through them.

It has since been proved that water and other liquids are compressible. In the year 1761, Canton communicated to the Royal Society the results of some experiments which proved this fact. He provided a glass tube with a bulb, like that of a common thermometer, and filled the bulb and a part of the tube with the liquid well purified from air. He then placed this in an apparatus called a condenser, by which he was enabled to submit the surface of the liquid in the tube to a very intense pressure of condensed air. He found that the level of the liquid in the tube fell in a perceptible degree upon the application of the pressure. The same experiment established the fact that liquids are *elastic*; for, upon removing the pressure, the liquid rose to its original level, and therefore resumed its former dimensions.

Elasticity does not always accompany compressibility. If lead or iron be submitted to the hammer, it may be hardened and diminished in its volume, but it will not resume its former volume after each stroke of the hammer.

There are some bodies which maintain the state of density in which they are commonly found by the continual agency of mechanical pressure, and such bodies are endued with a quality in virtue of which they would enlarge their dimensions without limit if the pressure which confines them were removed. Such bodies are called *elastic fluids or gases*, and always exist in the form of common air, in whose mechanical properties they participate. They are hence called *aeriform fluids*.

Those who are provided with an air-pump can easily establish this property experimentally. Take a flaccid bladder and place it under the glass receiver of an air-pump. By this instrument we shall be able to remove the air which surrounds the bladder under the receiver so as to relieve the small quantity of

air which is enclosed in the bladder from the pressure of the external air. When this is accomplished, the bladder will be observed to swell as if it were inflated, and will become perfectly distended. The air contained in it, therefore, has a tendency to dilate, which takes effect when it ceases to be resisted by the pressure of surrounding air.

It has been stated that the increase or diminution of temperature is accompanied by an increase or diminution of volume. Related to this there is another phenomenon, too remarkable to pass unnoticed, although this is not the proper place to dwell upon it: it is the converse of the former, viz., that all increase or diminution of bulk is accompanied by a diminution or increase of temperature. As the application of heat from some foreign source produces an increase of dimensions, so, if the dimensions be increased from any other cause, a corresponding portion of the heat which the body had before the enlargement will be absorbed in the process, and the temperature will be thereby diminished. In the same way, since the abstraction of heat causes a diminution of volume, so, if that diminution be caused by any other means, the body will give out the heat which in the other case was abstracted, and will rise in its temperature.

Numerous and well-known facts illustrate these observations. A smith, by hammering a piece of bar iron, and thereby compressing it, will render it red hot. When air is violently compressed, it becomes so hot as to ignite cotton and other substances. An ingenious instrument for producing a light for domestic uses has been constructed, consisting of a small cylinder, in which a solid piston moves air tight; a little tinder, or dry sponge, is attached to the bottom of the piston, which is then violently forced into the cylinder. The air between the bottom of the cylinder and the piston becomes intensely compressed, and evolves so much heat as to light the tinder.

In all the cases where friction or percussion produces heat or fire, it is because they are means of compression. The effects of flints—of pieces of wood rubbed together—the warmth produced by friction on the flesh—are all to be attributed to the same cause.

INERTIA.

The quality of matter which is of all others the most important in mechanical investigations, is that which has been called inertia.

Matter is incapable of spontaneous change. This is one of the earliest and most universal results of human observation; it is equivalent to stating that mere matter is deprived of life; for spontaneous action is the only test of the presence of the living principle. If we see a mass of matter undergo any change, we never seek for the cause of that change in the body itself; we look for some external cause producing it. This inability for voluntary change of state or qualities is a more general principle than inertia. At any given moment of time, a body must be in one or other of two states, rest or motion. Inertia, or inactivity, signifies the total absence of power to change this state. A body endued with inertia cannot of itself, and independent of all external influence, commence to move from a state of rest; neither can it, when moving, arrest its progress, and become quiescent.

The same property by which a body is unable by any power of its own to pass from a state of rest to one of motion, or *vice versa*, also renders it incapable of increasing or diminishing any motion which it may have received from an external cause. If a body be moving in a certain direction at the rate of ten miles per hour, it cannot, by any energy of its own, change its rate of motion to eleven or nine miles an hour. This is a direct consequence of that manifestation of inertia which has just been explained. For the same power

which would cause a body moving at ten miles an hour to increase its rate to eleven miles, would also cause the same body at rest to commence moving at the rate of one mile an hour; and the same power which would cause a body moving at the rate of ten miles an hour to move at the rate of nine miles in the hour, would cause the same body moving at the rate of one mile an hour to become quiescent. It therefore appears that to increase or diminish the motion of a body is an effect of the same kind as to change the state of rest into that of motion, or *vice versa*.

The effects and phenomena which hourly fall under our observation afford unnumbered examples of the inability of lifeless matter to put itself into motion, or to increase any motion which may have been communicated to it. But it does not happen that we have the same direct and frequent evidence of its inability to destroy or diminish any motion which it may have received. And hence it arises, that, while no one will deny to matter the former effect of inertia, few will at first acknowledge the latter. Indeed, even so late as the time of Kepler, philosophers themselves held it as a maxim, that "matter is more inclined to rest than to motion;" we ought not, therefore, to be surprised if, in the present day, those who have not been conversant with physical science are slow to believe that a body once put in motion would continue for ever to move with the same velocity, if it were not stopped by some external cause.

Reason, assisted by observation, will, however, soon dispel this illusion. Experience shows us in various ways that the same causes which destroy motion in one direction are capable of producing as much motion in the opposite direction. Thus, if a wheel, spinning on its axis with a certain velocity, be stopped by a hand seizing one of the spokes, the effort which accomplishes this is exactly the same as, had the wheel been previously at rest, would have put it in motion in the opposite direction with the same velocity. If a carriage drawn by horses be in motion, the same exertion of power in the horses is necessary to stop it, as would be necessary to *back* it, if it were at rest. Now, if this be admitted as a general principle, it must be evident that a body which can destroy or diminish its own motion must also be capable of putting itself into motion from a state of rest, or of increasing any motion which it has received. But this latter is contrary to all experience, and therefore we are compelled to admit that a body cannot diminish or destroy any motion which it has received.

Let us inquire why we are more disposed to admit the inability of matter to produce than to destroy motion in itself. We see most of those motions which take place around us on the surface of the earth subject to gradual decay, and if not renewed from time to time, they at length cease. A stone rolled along the ground, a wheel revolving on its axis, the heaving of the deep after a storm, and all other motions produced in bodies by external causes, decay, when the exciting cause is suspended; and if that cause do not renew its action, they ultimately cease.

But is there no exciting cause, on the other hand, which thus gradually deprives those bodies of their motion?—and if that cause were removed, or its intensity diminished, would not the motion continue, or be more slowly retarded? When a stone is rolled along the ground, the inequalities of its shape, as well as those of the ground, are impediments which retard and soon destroy its motion. Render the stone round, and the ground level, and the motion will be considerably prolonged. But still small asperities will remain on the stone, and on the surface over which it rolls: substitute for it a ball of highly polished steel, moving on a highly polished steel plane, truly level, and the motion will continue without sensible diminution for a very long period; but even here, and in every instance of motions produced by art, minute asper-

ities must exist on the surfaces which move in contact with each other, which must resist, gradually diminish, and ultimately destroy, the motion.

Independently of the obstructions to the continuation of motion arising from friction, there is another impediment to which all motions on the surface of the earth are liable—the resistance of the air. How much this may affect the continuation of motion, appears by many familiar effects. On a calm day, carry an open umbrella with its concave side presented in the direction in which you are moving, and a powerful resistance will be opposed to your progress, which will increase with every increase of the speed with which you move.

We are not, however, without direct experience to prove that motions when unresisted will for ever continue. In the heavens we find an apparatus, which furnishes a sublime verification of this principle. There, removed from all casual obstructions and resistances, the vast bodies of the universe roll on in their appointed paths, with unerring regularity, preserving without diminution all that motion which they received at their creation from the Hand which launched them into space. This alone, unsupported by other reasons, would be sufficient to establish the quality of inertia; but viewed in connexion with the other circumstances previously mentioned, no doubt can remain that this is a universal law of nature.

Organized bodies endued with the living principle, seem to be the only exceptions to this law. But even in these their members and all their component parts, separately considered, are inert, and are subject to the same laws as all other forms of matter. The quality of animation, from which they derive the power of spontaneous action or voluntary motion, does not belong to the parts, but to the whole, and not to the whole by any obvious or necessary connexion, because it is absent in sleep, and totally removed by death, even while the organization of every part remains, to all appearance, without derangement. Seeing, then, the whole visible material universe partaking in the common quality of inertia, unable to trace the conditions of *life* to any material phenomena, it is impossible not to conclude that the will of animated beings is the result of an immaterial principle, which, during the period of life, governs their organized bodies. In what this principle consists, what is its seat, or by what modes of action it moves the body, we are wholly unable to decide. But the same principle—analogy—which guides our investigations in every other part of physical science, ought to govern us in this; and by that principle, the spontaneous motion found in animated beings, but which in no instance is manifested by mere matter, must be attributed, not to the matter which composes the bodily forms of these beings, but to something of altogether a different nature.

Independently of this, which may be considered as the reasoning proper to physical science, philosophers have given another reason for assigning animation to an immaterial principle. The will, from the very nature of its acts, *m.s.* belong to a simple, uncompounded, and indivisible being, and consequently can never be an attribute of a thing which in its essence is the very reverse of this.

It has been proved that an inability to change the *quantity* of motion is a consequence of *inertia*. The inability to change the *direction* of motion is another consequence of this quality. The same cause which increases or diminishes motion, would also give motion to a body at rest; and therefore we inferred that the same inability which prevents a body from moving itself, will also prevent it from increasing or diminishing any motion which it has received. In the same manner we can show that any cause which changes the direction of motion would also give motion to a body at rest; and therefore if a body change the direction of its own motion, the same body might move itself

from a state of rest; and therefore the power of changing the direction of any motion which it may have received is inconsistent with the quality of inertia.

If a body moving from A to B, receive at B a blow in the direction C B E,

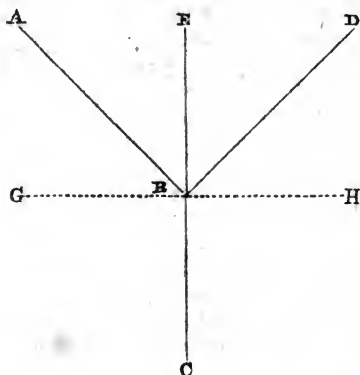

it will immediately change its direction to that of another line B D. The cause which produces this change of direction would have put the body in motion in the direction B E, had it been quiescent at B when it sustained the blow.

Again, suppose G H to be a hard plane surface; and let the body be supposed to be perfectly inelastic. When it strikes the surface at B, it will commence to move along it in the direction B H. This change of direction is produced by the resistance of the surface. If the body, instead of meeting the surface in the direction A B, had moved in the direction E B, perpendicular to it, all motion would have been destroyed, and the body reduced to a state of rest.

By the former example it appears that the deflecting cause would have put a quiescent body in motion, and by the latter it would have reduced a moving body to a state of rest. Hence the phenomenon of a change of direction is to be referred to the same class as the change from rest to motion, or from motion to rest. The quality of inertia is, therefore, inconsistent with any change in the direction of motion which does not arise from an external cause.

From all that has been here stated, we may infer generally, that an inanimate parcel of matter is incapable of changing its state of rest or motion; that, in whatever state it be, in that state it must for ever persevere, unless disturbed by some external cause; that if it be in motion, that motion must always be *uniform*, or must proceed at the same rate, the equal spaces being moved over in the same time; any increase of its rate must betray some impelling cause, any diminution must proceed from an impeding cause, and neither of these causes can exist in the body itself; that such motion must not only be constantly of the same uniform rate, but also must be always in the same direction, any deflection from its course necessarily arising from some external influence.

The language sometimes used to explain the property of inertia in popular works, is eminently calculated to mislead the student. The terms resistance and stubbornness to move are faulty in this respect. Inertia implies absolute passiveness, a perfect indifference to rest or motion. It implies as strongly the absence of all resistance to the reception of motion, as it does the absence of all power to move itself. The term *vis inertiae*, or *force of inactivity*, so fre-

quently used even by authors pretending to scientific accuracy, is still more reprehensible. It is a contradiction in terms : the term *inactivity* implying the absence of all force.

Before we close this subject, it may be advantageous to point out some practical and familiar examples of the general law of inertia. The student must, however, recollect that the great object of science is generalization, and that his mind is to be elevated to the contemplation of the *laws* of nature, and to receive a habit the very reverse of that which disposes us to enjoy the descent from generals to particulars. Instances, taken from the occurrences of ordinary life, may, however, be useful in verifying the general law, and in impressing it upon the memory ; and, for this reason, we shall occasionally, in the present treatise, refer to such examples : always, however, keeping them in subservience to the general principles of which they are manifestations, and on which the attention of the student should be fixed.

If a carriage, a horse, or a boat, moving with speed, be suddenly retarded or stopped by any cause which does not at the same time affect passengers, riders, or any loose bodies which are carried, they will be precipitated in the direction of the motion ; because, by reason of their inertia, they persevere in the motion which they share in common with that which transported them, and are not deprived of that motion by the same cause.

If a passenger leap from a carriage in rapid motion, he will fall in the direction in which the carriage is moving at the moment his feet meet the ground ; because his body, on quitting the vehicle, retains, by its inertia, the motion which it had in common with it. When he reaches the ground, this motion is destroyed by the resistance of the ground to the feet, but is retained in the upper and heavier part of the body ; so that the same effect is produced as if the feet had been tripped.

When a carriage is once put in motion with a determinate speed on a level road, the only force necessary to sustain the motion is that which is sufficient to overcome the friction of the road ; but at starting, a greater expenditure of force is necessary, inasmuch as not only the friction is to be overcome, but the force with which the vehicle is intended to move must be communicated to it. Hence we see that horses make a much greater exertion at starting than subsequently, when the carriage is in motion ; and we may also infer the inexpediency of attempting to start at full speed, especially with heavy carriages.

Coursing owes all its interest to the instinctive consciousness of the nature of inertia which seems to govern the measures of the hare. The greyhound is a comparatively heavy body moving at the same or greater speed in pursuit. The hare *doubles*, that is, suddenly changes the direction of her course, and turns back at an oblique angle with the direction in which she had been running. The greyhound, unable to resist the tendency of its body to persevere in the rapid motion it had acquired, is urged forward many yards before it is able to check its speed and return to the pursuit. Meanwhile the hare is gaining ground in the other direction, so that the animals are at a very considerable distance asunder when the pursuit is recommenced. In this way, a hare, though much less fleet than a greyhound, will often escape it.

In racing, the horses shoot far beyond the winning-post before their course can be arrested.

Remarkable effects of the inertia of matter are constantly exhibited in the accidents from collision which take place on railways. In England, where the speed is much greater than is customary in this country, such instances are more frequent and fatal. The evenness and perfection of the roads and carriages conspire with the extraordinary speed to render it difficult to stop

the cars. When moving at thirty or forty miles an hour, the steam must generally be cut off a mile before arriving at a station. Accidental obstacles, not foreseen or expected, are therefore almost always the cause of collisions.

ELASTICITY OF AIR.

Exhausting Syringe.—Rate of Exhaustion.—Impossible to produce a perfect Vacuum.—Mechanical Defects.—The Air-Pump.—Barometer Gauge.—Siphon Gauge.—Various Forms of Air-Pump.—Pump without Suction-Valve.—Experiments with Air-Pump.—Bladder burst by atmospheric Pressure.—Bladder burst by Elasticity of Air.—Dried Fruit inflated by fixed Air.—Flacid Bladder swells by Expansion.—Water raised by Elastic Force.—A Pump cannot act in the Absence of atmospheric Pressure.—Suction ceases when this Pressure is removed.—The Magdeburg Hemisphere.—Guinea and Feather Experiment.—Cupping.—Effervescing Liquors.—Sparkling of Champagne, &c.—Presence of Air necessary for the Transmission of Sound.—The condensing Syringe.—The Condenser.

THE HISTORY OF THE

1792
1793
1794
1795
1796
1797
1798
1799
1800

ELASTICITY OF AIR.

WHEN a part of the air enclosed in any vessel is withdrawn, that which remains expanding by its elastic property, fills the dimensions of the vessel as effectually as before. Under these circumstances, however, it is obvious that any given space within the vessel contains a less quantity of air than it did previously, inasmuch as while the whole dimensions of a vessel remain the same, the total quantity of air diffused through them is diminished. When the same quantity of air in this manner is caused to expand into a greater space, it is said to be *rarefied*.

But on the other hand, when a vessel containing any quantity of air is caused to receive an increased quantity by additional air being forced into it, then any given portion of its dimensions will contain a proportionally greater quantity of air than it did before the additional air had been forced in. Under these circumstances, the air contained in the vessel is said to be *condensed*, and it is our purpose in the present lecture to describe the mechanical instruments by which these processes of *rarefaction* and *condensation* are practically effected.

THE EXHAUSTING SYRINGE.

The most simple form of instrument for producing the rarefaction of air, is that which is called *the exhausting syringe*. In order to comprehend the construction and operation of this instrument, let us suppose A, B, fig. 1, a cylinder, or barrel, furnished with a stop-cock C, inserted in a small aperture in the bottom. Let the end of this tube be screwed upon the vessel R, in which the rarefaction is to be made.

From the side of the barrel near the bottom, let another tube, D, proceed, also furnished with a stop-cock. Let us suppose the piston P, at the bottom of the barrel, both stop-cocks being closed. Let the piston P be now drawn from the bottom to the top, as represented in fig. 2, this piston being supposed to move air-tight in the barrel. A vacuum will remain between the piston P

Fig. 1.

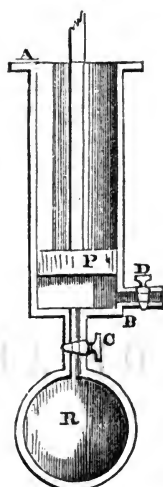
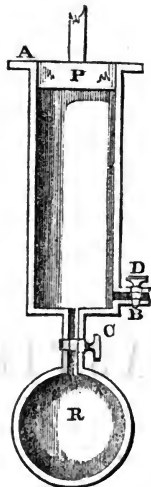

Fig. 2.



and the bottom B. If the stop-cock C be opened, the air contained in the vessel R, will, by its elastic force, rush through the open stop-cock C, and expand so as to fill the barrel. Thus the air which previously occupied the dimensions of the vessel R, has now expanded through the dimensions of R and A, B. Let the stop-cock C, be now closed, and the stop-cock D opened, and let the piston P be pressed to the bottom of the barrel. The air contained in the barrel will thus be forced out at the open stop-cock D, and driven into external atmosphere. Let the stop-cock D be next closed, and the piston again elevated, as in fig. 2. A vacuum will once more be produced in the barrel, and on opening the stop-cock C, the air in R will again expand into the barrel, occupying the extended dimensions as before. Let the stop-cock C be again closed, and the stop-cock D opened. If the piston be pressed to the bottom of the barrel as before, the air contained in the cylinder will again be expelled through the stop-cock D. By continuing this process, alternately opening and closing the two stop-cocks, and elevating and depressing the piston, a quantity of air will rush from the vessel R, on each ascent of the piston, and the same quantity will be expelled through the tube D, on each descent of the piston.

It is evident that this process may be continued so long as the air which remains in R, is capable of expanding, by its elasticity, through the open tube, C, into the barrel above.

A slight degree of attention only is necessary to perceive that the quantity of air expelled from R, at each ascent of the piston, is continually diminished; and it will not be difficult even to explain the exact rate at which this diminution proceeds. Let us suppose the magnitude of the barrel A, B, to have any given proportion to the dimensions of the vessel R; suppose, for example, that the dimensions of the barrel are the ninth part of those of the vessel. When the piston is first raised from the bottom to the top, the air which previously occupied the vessel expands so as to occupy the dimensions of the vessel and barrel together. The barrel, therefore, will contain a tenth part of the whole of the enclosed air; for, since the vessel R contains nine times as much as the barrel, the vessel and barrel together contain ten times as much as the barrel. Consequently, the air enclosed in the barrel will necessarily be a tenth of the

whole. On depressing the piston, this tenth part is expelled through the tube D. On elevating the piston, the air remaining in the vessel R, which is nine tenths of the original quantity, now expands through the vessel and barrel, and, for the reason already assigned, the barrel will contain a tenth part of this remaining nine tenths; that is, it will contain nine hundredth parts of the original quantity. On the second descent of the piston, this nine hundredth parts will be expelled. The nine tenths which remain in the cylinder after the first stroke of the piston, have now lost nine hundredth parts of the whole, and since nine tenths are the same as ninety hundredths, nine hundredths being deducted from that leave a remainder of eighty-one hundredths.

This, therefore, is the proportion of the original quantity which now remains in the vessel R. When the piston is next raised, this portion will expand as before into the enlarged space, and the tenth part of it will rise into the barrel. But a tenth part of eighty-one hundredths is eighty-one thousandths. Accordingly, on the next descent, this eighty-one thousandths will be expelled. The eighty-one hundredths which remain in the vessel R before this diminution, are thus diminished by eighty-one thousandths. This eighty-one hundredths are equivalent to eight hundred and ten thousandths, and therefore the quantity remaining in the vessel R, will be found by subtracting eighty-one thousandths from eight hundred and ten thousandths.

The remainder will therefore be seven hundred and twenty-nine thousandths, which will be the proportion of the original quantity of air which remains in the vessel after the third stroke of the piston. It will not be difficult to continue this reasoning further, and to discover, not only the quantity of air expelled at each successive stroke, but also the quantity remaining in the vessel R; and we may without difficulty compute the following table:—

Number of Strokes.	Proportion of the original quantity of air expelled at each stroke.	Proportion of the original quantity of air remaining after each stroke.	Total quantity of air expelled.
1	$\frac{1}{10}$	$\frac{9}{10}$	$\frac{1}{10}$
2	$\frac{9}{100}$	$\frac{81}{100}$	$\frac{19}{100}$
3	$\frac{81}{1,000}$	$\frac{729}{1,000}$	$\frac{271}{1,000}$
4	$\frac{729}{10,000}$	$\frac{6,491}{10,000}$	$\frac{3,509}{10,000}$
5	$\frac{6,491}{100,000}$	$\frac{58,419}{100,000}$	$\frac{41,5^*1}{100,000}$
6	$\frac{58,419}{1,000,000}$	$\frac{525,771}{1,000,000}$	$\frac{474,229}{1,000,000}$
7	$\frac{52,771}{10,000,000}$	$\frac{4,731,939}{10,000,000}$	$\frac{5,268,061}{10,000,000}$

To make this table more intelligible, let us suppose that the vessel, R, contains in the first instance, ten million grains of air. The first stroke of the piston expels a tenth part of this quantity, that is, one million grains. There remain in the vessel, R, nine million grains. The tenth part of this nine million is expelled by the second stroke, that is nine hundred thousand grains

of air. There now remain in the vessel eight million, one hundred thousand grains. Of this again a tenth part is expelled by the third stroke, that is, eight hundred and ten thousand grains. The quantity remaining in the receiver will then be seven million, two hundred and ninety thousand grains. The tenth part of this is expelled by the fourth stroke, that is, seven hundred and twenty-nine thousand grains, and there remain in the vessel six million, four hundred and ninety-one thousand grains. The fifth stroke expels a tenth part of this, or six hundred forty-nine thousand, one hundred grains, and there then remain in the vessel five million, eight hundred forty-one thousand, nine hundred grains. A tenth part of this again is expelled by the sixth stroke, that is, five hundred eighty-four thousand, one hundred and ninety grains, and the remainder in the vessel is five million, two hundred and fifty-seven thousand, seven hundred and ten grains. A tenth of this again, or five hundred twenty-five thousand, seven hundred and seventy-one grains, is expelled by the seventh stroke. The following table exhibits these results:—

Number of Strokes.	Grains expelled at each Stroke.	Grains remaining under Pressure.	Total number of grains Expelled.
1	1,000,000	9,000,000	1,000,000
2	900,000	8,100,000	1,900,000
3	810,000	7,290,000	2,710,000
4	729,000	6,491,000	3,439,000
5	649,100	5,841,900	4,158,100
6	584,190	5,257,710	4,742,290
7	525,771	4,731,939	5,268,061

By attending to the numbers in the third column of the above table, it will be perceived that each succeeding number is nine tenths of the preceding one. It follows, therefore, that after each stroke of the piston, the quantity of air which remains in the vessel R, will be nine tenths of the quantity which it contained before the stroke. From a due consideration of this circumstance it will be perceived that, however long the process of rarefaction be continued, the vessel R, can never be completely exhausted of air, for a determinate quantity being contained in it, nine tenths of this will remain after the first stroke. After the second stroke, nine tenths of this again will remain, and however long the operation be continued, still a determinate quantity will remain after every succeeding stroke of the piston, this quantity being nine tenths of what the vessel R contained after the preceding stroke. But, although a perfect exhaustion can never be attained by these means, yet if the instrument now described could be constructed as perfect in practice as it is in theory, there would be no limit whatever to the degree to which the air in the vessel R might be rarefied. Thus, by a determinate and finite number of descents of the piston, it might be reduced in weight to the millionth part of a grain, or even to a quantity millions of times less than this. Still, however small the quantity which may remain in the vessel R, so long as the elastic force by which the particles repel each other exceeds the weight of the final or ultimate particles of the air, so long that repulsive energy will cause it to expand through the tube C, into the cylinder, A, B.

Fig. 3.

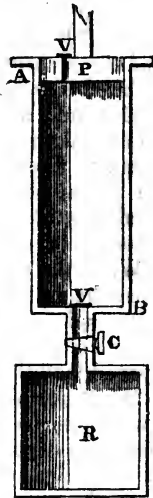

The exhausting syringe used in practice differs in some particulars from that which we have here described with a view to illustrate the principle of its operation. The stop-cocks C and D, which would require constant manipulation while the process of rarefaction is going forward, are dispensed with in practice, and the elastic pressure of the air itself is made to act upon valves which serve the purposes of these cocks. Let A, B, fig. 3, represent an exhausting syringe, having a tube and stop-cock, C, proceeding from the lower part, as already described. The tube C, is screwed to a very small aperture in the bottom of the barrel. Across this aperture is stretched a small piece of oiled silk, which is impervious to air. It is extended across the aperture so loosely, that a slight pressure from below will produce an open space between it and the surface of the bottom near the aperture capable of admitting air from below, and yet so tight, that a pressure from above will cause it to lie close against the bottom round the aperture, so as to stop the passage of air from above.

By this arrangement it is possible for air pressed with a sufficient force to enter the barrel through the valve V, when the stop-cock C is opened; but it is impossible, on the other hand, for air pressing above the valve to escape through it, since the pressure of the air only serves to render more close the contact between the valve and the surface surrounding the aperture which it covers. A small hole is pierced through the piston, extending from the lower to the upper surface, and this hole at the upper surface is covered with an oiled silk valve V', in the same manner as the aperture V, in the bottom. For the reasons already assigned, it is, therefore, possible for air to pass up through this hole in the piston, and escape at the upper surface; but it is impossible for air, by any pressure, to pass in the contrary direction, since such pressure only renders the contact of the valve more intimate, and consequently causes it to be more impervious to air.

Let us suppose an instrument thus constructed to be attached to a vessel, R, in which the rarefaction is to be produced, and the stop-cock C to be opened. On raising the piston P, a vacuum will be produced between it and the valve V. The piston-valve V' will now be pressed downward by the

weight of the atmosphere, and will be subject to no pressure from below, because of the absence of air beneath it. It will then stop the admission of air from above the aperture, and will maintain the vacuum below. The elastic force of the air contained in the vessel R, now acting upward against the exhausting valve V, will raise it, and the air will escape through the space between it and the surface surrounding the aperture, and will thus fill the barrel above; but the air having expanded into an increased space will have an elastic force less than that of the external air, and consequently the piston-valve V' will be pressed down by a greater force than it is pressed up, and will therefore remain closed. Let the piston be now depressed; as it descends, the air enclosed in the cylinder acquires increased elastic force, and pressing upon the exhausting-valve V, causes it to close, so as to intercept the air in the cylinder from the vessel R. When the piston has descended in the barrel through such a space as to condense the air beneath it, so as to give it a greater elastic force than the external atmosphere, it will press the piston-valve V' upward with a greater force than the external air presses it downward. Consequently the valve V' will be opened, and the air confined beneath the piston will begin to escape through it. When the piston has arrived at the bottom of the barrel, the whole of the air will thus be expelled. This process is repeated whenever the piston is raised and depressed, and thus the valves, which in the form adapted for explanation, required constant manipulation, acquire a self-acting property. This form of the instrument, which is that commonly used, is attended with an obvious limit to its operation, which does not exist in the theoretical form represented in fig. 1. It is evident that the operation of the valves depends upon the presence of air of a certain determinate elastic force, in the vessel R, which elastic force it is the purpose of the instrument to reduce indefinitely. When the elastic force of the air contained in R, is so far diminished that it is only equal to the force required to raise the valve V, the action of the machine must stop, for any further diminution would render the air confined in R unable to open the valve, and therefore no more air could pass into the barrel A, B. This is a practical limit of the power of the exhausting syringe. The degree of perfection of which the instrument is susceptible, therefore, depends upon making the valve V, offer as little resistance to being raised as is consistent with its being perfectly air-tight when closed.

But we have another limit to the operation of this instrument, arising from the piston-valve V'. This valve is closed, not only by its own tension, but also by the weight of the incumbent atmosphere above it. When the piston is depressed, the air included in the barrel must first attain a degree of elastic force by condensation equal to the pressure of the atmosphere, before it can open the valve V'. But this is not sufficient: it must acquire a further increased elastic force equal to the tension of the valve V', over the aperture, in order to raise that valve and escape, and therefore the perfection of this valve also depends on having as little tension as is consistent with being perfectly air-tight from above.

The efficiency of the instrument will also depend upon the accuracy with which the piston fits the bottom and sides of the barrel. When the piston is depressed to the bottom, it is considered in theory to be in absolute contact, so as to exclude every particle of air from the space between it and the bottom. But in practice, this perfection can never be obtained. It may, however, be very accurately fitted, and the air retained between it and the bottom may be reduced almost without limit. The small hole which passes from the valve V' to the bottom of the piston, will still remain, however, and will continue to be a receptacle for air, even when the piston is in close contact with the bottom. This space, therefore, produces a defect in the machine which is not

removed. If we suppose the magnitude of this hole, together with whatever space may remain unfilled between the lower surface of the piston and the bottom of the barrel, to be the ten thousandth part of a solid inch, then the valve V' will cease to act when the air which fills the barrel, the piston being at the top, is such that if condensed into the ten thousandth part of an inch, its elastic force will exceed the atmospheric pressure by a quantity less than the force required to open the valve V' . This source of imperfection will evidently be diminished by diminishing the depth of the aperture below the valve V' , and by increasing the size of the cylinder; for if the air in the barrel be as many times rarer than the external atmosphere, as the magnitude of the barrel is greater than the magnitude of the space below the valve V' , then this air, when condensed into that space, will exert a pressure equal to that of the atmosphere. Suppose the barrel contains ten cubic inches of air, and that the magnitude of the hole is the hundredth part of a cubic inch, then the magnitude of the cylinder will be one thousand times the magnitude of the space which remains between the valve V' and the bottom of the barrel, when the piston is pressed to the bottom. Consequently the process of rarefaction would be deduced, until the air in the receiver would be rendered one thousand times rarer than the external atmosphere.

The vessel R , being connected with a tube furnished with a stop-cock C , may be detached from the syringe, together with the stop-cock, by unscrewing the tube C ; and if the stop-cock be previously closed, the interior of the vessel will continue to contain the rarefied air.

In various branches of physical science, inquiries continually arise, respecting qualities and effects of material substances, which are subject to considerable modification by the pressure or other qualities of the air which surrounds them; and it is often necessary in such investigations to discover what these qualities and effects may be, if the substances were not exposed to the mechanical pressure or other effects consequent upon the presence of the atmosphere. Although we do not possess any means of removing altogether the presence of this fluid, yet, from what has been already stated, it is plain that it may be so attenuated in an enclosed chamber, such as the vessel R , that these effects may be diminished in intensity to any degree which experimental inquiry may demand.

With these views it is necessary, however, not only to be able to introduce the substances which are submitted to experimental investigation, into the chamber in which the rarefaction has been accomplished, but also to be able to observe them when so situated. The latter purpose could be accomplished by constructing the receptacle R , of glass; but still it would be necessary to have access to the interior, and to construct it of a convenient form to receive the subjects of experiment, and even in many cases to be able to manipulate or produce changes of position on the object thus enclosed.

For these purposes, the form of the vessel R , and the mode of connecting it with the syringe, must be somewhat changed, and the arrangement which is given, in order to adapt them thus to all the exigencies of experimental investigation, is called *the air-pump*, an instrument which we will now proceed to explain.

THE AIR-PUMP.

The vessel in which the rarefaction is produced by an air-pump, is called a receiver, and is usually constructed of glass in a cylindrical form, with an arched or round top, furnished with a ball as a convenient handle. A section, R , of this is represented in fig. 4. The mouth, or lower part, is open, and it

Fig. 4.

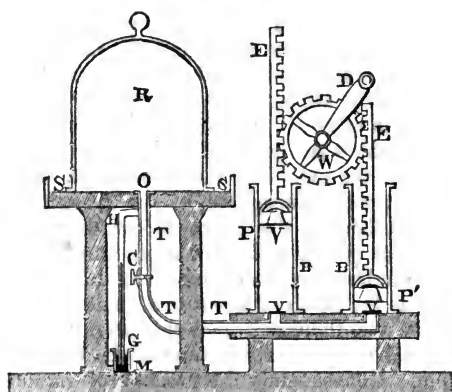

is ground to a perfectly smooth and flat edge. A circular brass plate is constructed, also ground truly plane, and perfectly smooth, and its magnitude is accommodated to the size of the largest receiver intended to be used; a section of this plate is represented at S, S.

When the receiver is placed on the plate with its mouth downward, the edge of the mouth and the surface of the plate should be so truly plane and smooth that they may rest in air-tight contact. This may always be insured by smearing the ground edge of the receiver with a little lard or unctuous matter. When the receiver is thus laid on the plate, it becomes an enclosed chamber, similar to R, fig. 3, but with this convenience, that any substance or object to be submitted to experiment may be previously placed under it, and observed through it after the air has been rarefied. In the centre of the plate S, S, a small aperture O, communicates with a tube T, analogous to the tube inserted in the bottom of the syringe in fig. 3. This tube is furnished with a stop-cock at C, which, when closed, cuts off all communication between the receiver and the syringe, and when open allows the syringe to act on the receiver as already described.

The syringe B, furnished with a piston P, is fixed on a firm stand, and the tube T, is carried in such a direction as to open a communication with the valve V, in the bottom of the syringe. To facilitate the operation, it is usual to raise and depress the piston, not by the hand applied at the extremity of the piston-rod, as formerly described, but by a winch, D, which turns a toothed wheel, W, working in corresponding teeth, formed on the edged of the piston-rod E.

It is not necessary again to describe the operation of the syringe, since it is exactly what has been already explained with reference to fig. 3. The piston P, is elevated and depressed by alternately turning the wheel W, in opposite directions, and the piston-valve V', and the exhausting-valve V, have the property and work in the manner already described. This instrument, and that represented in fig. 3, differ in nothing except the length and shape of the communicating-tube T, the shape of the receiver R, and the mechanical method of working the piston.

To expedite the process of rarefaction, it is usual to provide two syringes worked by the same wheel, as represented in the figure, each being drawn up while the other is depressed. By these means a given degree of rarefaction is produced in half the time which would be required with a single syringe.

In using this instrument, it is always desirable and frequently necessary to ascertain the degree of rarefaction which has been accomplished within the receiver. This is indicated with great precision, by an apparatus called a barometric-gauge, represented at H, G. This consists of a glass tube H, G, the upper end, H, of which has free communication with the receiver, or rather with the tube T, at some point above the stop-cock C. The tube H, G, is more than thirty inches in length, and its lower extremity is plunged into a small cistern of mercury. As the rarefaction proceeds in the receiver, the elastic force of the air pressing upon the mercury in the tube H, G, is diminished, and immediately becomes less than the pressure of the external atmosphere on the surface of the mercury in the cistern M; consequently this external pressure prevails, and forces mercury up to a certain height in the tube H, G. As the rarefaction of the air in the receiver increases, its elastic force being diminished, the atmospheric pressure will prevail with increased effect, and will cause the column sustained in the tube to rise. The weight of this column, combined with the elastic pressure of the air remaining in the receiver, is equal to the atmospheric pressure, because they are balanced by it, and it is therefore apparent that the elastic pressure of the air in the receiver must be equal to the excess of the atmospheric pressure above the weight of the mercurial column in the tube. Let us suppose that the common barometer stands at thirty inches, and that the column in the gauge measures twenty-seven inches, the difference between these, namely, three inches of mercury, will express the elastic force of the rarefied air in the receiver, for the column of thirty inches in the barometer measures the atmospheric pressure, and the column of twenty-seven inches in the gauge must be added to the pressure of the rarefied air, in order to obtain the force which balances this pressure; therefore the force of the rarefied air must be equivalent to the pressure of three inches, by which the barometric column exceeds the mercurial column suspended in the gauge.

In small pumps, which are used on the table, gauges of this form are rejected in consequence of their inconvenient dimensions. An instrument called a siphon-gauge is then used, the principle of which is easily understood. A

Fig. 5.

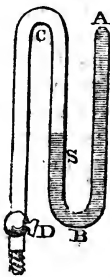

small glass tube, of eight or ten inches in length, is bent into the form A, B, C, D, represented in fig. 5. The extremity A, is closed, and the extremity D, opened, and furnished with a screw, by which it may be attached to a tube connected with the tube T, fig. 4, above the stop-cock C. Pure mercury is poured into the tube A, B, C, D, fig. 5, until the leg A, B, is completely filled, and the mercury rises to S, about half an inch above the inflection B. The pressure of the atmosphere communicating freely with the surface S, through D, C, will maintain the mercury in the space S, B, A, and will prevent the surface S, from rising toward C, by the pressure of the column B, A. When D

is screwed to the pump, and put in communication with the exhausting-tube T, fig. 4, above the stop-cock C, then the surface S, will be pressed by the elastic force of the air in the receiver R, with which it communicates. So long as that elastic force is capable of sustaining the column of mercury in the leg B, above the level of the surface S, this instrument will give no indication of the degree of rarefaction; but when by the operation of the syringe, the air in the receiver is so far exhausted that its elastic force is unable to sustain the mercurial column in B, A, above the level S, then the mercury will begin to fall in the leg B, A, and the surface S will rise in the leg B, C. The column suspended in the leg B, A, above the level S, will now be the exact measure of the elastic force of the air in the receiver which sustains it. In this respect the siphon-gauge must be regarded as a more direct measure of the elastic force of the air in the receiver than the barometer-gauge. The latter, in fact, measures not the elastic force of the air in the receiver, but the difference between that elastic force and the pressure of the atmosphere.

To obtain the elastic force of the air in the receiver, it is necessary also to ascertain the indications of the barometer. The siphon-gauge, however, gives at once the pressure of the air in the receiver.

The air-pump has been constructed from time to time in a great variety of forms, the details of which it would not be proper to introduce into the present treatise. The general principle in all is the same; they differ from each other chiefly in the construction of the piston and valves.

In the form which has been above described, the air effects its escape from the receiver at each stroke of the piston by opening the suction-valve V, fig. 4. Now in whatever way this valve is constructed, it must require some determinate force to raise it, and this force, in the case already described, is the elastic force of the rarefied air remaining in the receiver. Thus the operation of the machine is accomplished by the presence in the receiver of the very agent which it is the object of the machine itself to remove, and from the very construction of the instrument it must cease to act while yet air of a determinate pressure remains in the receiver.

This defect has been sometimes attempted to be removed by causing the suction-valve to open, not by the pressure of the rarefied air, but by some mechanical means acted upon by the piston. Such contrivances, however, are found to be attended with peculiar inconveniences which more than outweigh their advantages. Probably the most simple and the best contrivance is one in which the suction-valve is altogether dispensed with and the air passes freely through the open tubes from the receiver to the pump-barrel. Let T, fig. 6, be the exhausting-tube which is carried from the receiver, and enters the pump-barrel at a point distant from the bottom of the barrel by a space equal to the thickness of the piston. The piston P, is a solid plug which moves air-tight in the barrel, and is propelled by a polished cylindrical rod which slides in an air-tight collar C, in the top of the cylinder, which in this case is closed. A valve is placed in the top of the cylinder, which opens outward, and which may be constructed in the same manner as the silk-valves already described. When the piston descends it leaves a vacuum above it—the external air not being allowed admission through the valve at the top; and when the piston arrives at the bottom of the barrel, it has passed the mouth of the exhausting-tube T, and fills the space below it. The air in the receiver then expands into the empty pump-barrel, and when the piston is raised, having passed the mouth of the tube T, the air which has expanded into the barrel is confined between the piston and the top, where, as the piston rises, it is condensed. When it acquires sufficient elastic force it opens the valve at the top and is discharged into the atmosphere.

Fig. 6.

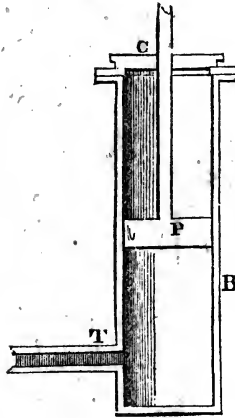

The valve in the top of the barrel is in this case continually under the atmospheric pressure, and therefore the air confined in the pump can never be driven through it, until it is condensed by the piston, so that its force shall be greater than that of the atmosphere. From the causes already explained, arising from inaccuracy of mechanical construction, some small space must inevitably remain between the piston and the top of the barrel, even when the piston is drawn upward as far as possible. This small space will contain condensed air, and the valve at C will cease to act when the air which occupies this space exceeds the atmospheric pressure by a force less than the tension of the valve.

When the piston is pressed to the bottom, a small space will likewise remain between the piston and the bottom, which will be occupied by air, but at each ascent of the piston this air expands, and is subject to constant diminution as the working of the pump is continued. The principal source of imperfection in such an instrument, independently of that which arises from mechanical inaccuracy of its construction, depends on the tension of the valve in the top, and the pressure of the atmosphere upon it. To diminish this imperfection, the valve in the top is sometimes made to communicate by a pipe with a small subsidiary exhausting-syringe, by which the pressure of the atmosphere on the valve may be partially withdrawn, so that a less force acting under the valve may open it.

A perspective view of an air-pump, with all its accompaniments, constructed upon this principle, is exhibited in fig 7, where the several parts of the machine are marked with the same letters as the corresponding part in the sectional diagram, fig. 4. The subsidiary syringe just alluded to, is also represented at G. It is worked by a handle, H.

EXPERIMENTS WITH THE AIR-PUMP.

The pressure and elasticity of air are capable of being strikingly illustrated in various ways by experiments with the air-pump.

If a glass receiver, open at both ends, have a strong bladder tied upon one end so as to be air-tight, and be placed upon the open end on the plate of an air-pump, when the air is exhausted from the receiver, the pressure of the external atmosphere on the bladder will immediately cause its upper surface to be con-

Fig. 7.

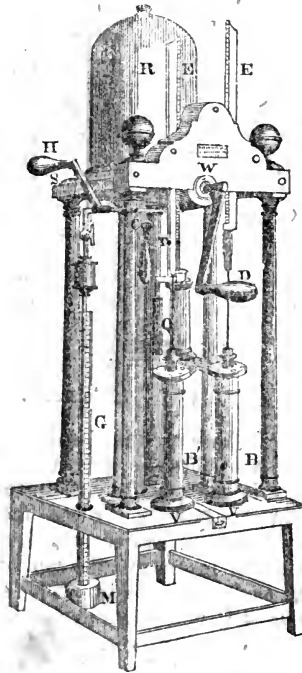

cave, and when the air is sufficiently rarefied within the receiver, the pressure on the bladder will burst it, producing a loud noise like the discharge of a pistol. Again, if a large glass bowl, having a bladder tied firmly on its mouth so as to be perfectly air-tight, be placed under the receiver of the air-pump, on withdrawing the air, the elastic force of the air confined in the bowl being still undiminished, and being no longer balanced by the atmospheric pressure on the outside, the bladder will be blown into a convex form, and when the air in the receiver is so rarefied that the elasticity of the air confined in the bowl suffers little resistance, the bladder will burst, and the air confined in the bowl will expand through the receiver.

Fruit, when dried and shrivelled, contains within it particles of air, which are held in its pores by the pressure of the external atmosphere. If, therefore, this pressure be removed, we may expect that the air thus confined will expand, and if there is no aperture in the skin of the fruit for its escape, it will distend the skin. Fruit, in this case, placed under a receiver, will assume the appearance of ripeness, by exhausting the air; for the expansion of the air contained in the fruit, by inflating the skin, will give it a fresh, ripe appearance. Thus a shrivelled apple will appear to grow suddenly ripe and fresh, and a bunch of raisins will be converted into a bunch of ripe grapes.

A flaccid bladder closed so as to be air-tight at the mouth, contains within it a small portion of air. This air presses, by its elasticity, on the inner surface, which is resisted by the atmospheric pressure from without. If such a bladder be placed under the receiver of a pump, and the air exhausted, the external pressure being thus removed, the elasticity of the air included will cause the bladder to swell, and it will take all the appearance of being fully inflated.

Such a bladder, placed under several heavy weights will raise them by the expansion of the air.

Fig. 8.



Let a close glass vessel, A, B, fig. 8, be partially filled with water B, and let the tube C D be inserted through its neck, the end D being below the surface of the water; the air above the surface will thus be confined. If such a vessel be placed under a receiver, and the air be withdrawn, the elastic force of the air confined in A, B, above the surface of the water, will press the water up in the tube D, C, from which it will issue in a stream at C, when the pressure of the atmosphere is removed by rarefaction.

By means of an air-pump, we are enabled to demonstrate that the power which causes water to follow the piston in a pump is the atmospheric pressure, by showing that the water will not follow the piston when that atmospheric pressure is removed. Let a small exhausting-syringe, with its lower end in a vessel of water, be placed on the plate of the air-pump, and let a glass receiver, open at the top, be placed over it. On the top of this receiver let a brass cap fitting it air-tight be placed, through a hole in the centre of which a metal rod, terminating in a hook, passes air-tight. Let the hook be attached to the end of the piston-rod, so that by drawing the rod up through the air-tight collar, the piston may be drawn from the bottom of the cylinder toward the top. If this be done before the air has been exhausted from the receiver, the water will be found to rise after the piston as in the common pump; but as soon as the air in the receiver has been highly rarefied, it will be found that although the piston may be drawn up in the syringe, the water will not follow it. This effect may be rendered visible by constructing the barrel of the pump or syringe of glass, through which the water will be seen to rise in the one case and not in the other. If an air-tight piston be placed in close contact with the bottom of a syringe not furnished with a valve, any attempt to draw it up will be resisted by the atmospheric pressure; and if it be forced to the top of the cylinder and there discharged, it will be immediately urged with considerable force, to the bottom. The atmospheric pressure above the piston, acting with a force of about fifteen pounds on the square inch, produces this effect, for the space between the piston and the bottom of the cylinder not containing any air, this pressure is unresisted. Now if this piston be introduced under the receiver of an air-pump, and be drawn up as already described, it will be found that in proportion as the air is withdrawn from the receiver, less and less force will be required to produce the effect; and at length, the rarefaction will become so great, that the pressure of the remaining air is incapable of overcoming the friction

of the piston with the cylinder, and it will when drawn to the top remain there, without returning to the bottom. In this state let the air be readmitted to the receiver, the piston will then be immediately pressed to the bottom of the cylinder.

The celebrated experiment of the Magdeburgh hemispheres may be performed by means of an air-pump. Two hollow hemispheres constructed of brass as represented in fig. 9, are so formed that when placed mouth to mouth

Fig. 9.



they shall be in air-tight contact. They are furnished with handles, one of which may be screwed off. In the neck to which this handle is screwed is a tube furnished with a stop-cock. The handle being screwed off, let the hemisphere be screwed on the pump-plate, and the other hemisphere being placed over it, let the stop-cock be opened so as to leave a free communication between the interior of the sphere and the exhausting-tube of the air-pump. The pump being now worked, the interior of the sphere will form the receiver, from which all communication with the external air is cut off, and rarefaction will be produced in it to any degree which may be desired. This being effected, let the stop-cock be closed; and let the sphere be detached from the pump-plate, and the handle screwed upon it. If then the two handles be drawn in opposite directions, so as to pull the hemispheres from one another, it will be found that they will resist with considerable force. If the diameter of the sphere be six inches, its section through the centre will be about twenty-eight square inches. The hemispheres will be pressed together by a force amounting to fifteen pounds for every square inch in the section. If twenty-eight be multiplied by fifteen, we shall obtain four hundred and twenty-two, which is the amount of the force with which the hemispheres will be held together. If one of the handles be placed on a strong hook, and a weight of four hundred pounds be suspended from the other, the weight will be supported by the pressure of the atmosphere.

This was one of the earliest experiments in which the effects of atmospheric pressure were exhibited. Otto Guericke, the inventor of the air-pump, constructed, in 1654, a pair of such hemispheres, one foot in diameter. The section through the centre of these was about one hundred and thirteen square inches, which multiplied by fifteen gives a pressure amounting to about seventeen hundred pounds. If the exhaustion were complete, the hemispheres would be held together by this force; but, even though incomplete, they were still able to resist a prodigious force tending to draw them asunder.

It is a consequence of the general theory of gravitation, that under the same circumstances, bodies are attracted in proportion to their mass; and hence it

would follow that all bodies, whatever be their masses, should fall at the same rate. Now the instances which most commonly come under our observation seem to contradict this inference, for we find a piece of metal and a piece of paper fall at very different rates, and still more different is the rate at which a piece of metal and a feather would fall. The cause of this circumstance, however, is easily explained. The resistance offered by the air is proportional to the quantity of surface which the body presents in the direction of its motion. Now the metal may present a considerably less surface than the feather, while the force which it exerts to overcome the resistance is many times greater, because of its greater weight. Hence, it follows that the resistance of the air produces a different effect on the metal compared with the effect which it produces on the feather; but all doubt will be removed if the feather and the metal are allowed to fall in a chamber from which the air has been withdrawn. A glass receiver is represented in fig. 10, which may be

Fig. 10.



placed on the plate of an air-pump, and on the top is placed a brass cover, which is air-tight. Under this several brass stages are attached, constructed in the manner of trap-doors on the hinges, and supported by small pins, which project from the sides of a metal rod, passing through an air-tight collar in the brass cover. By turning this metal rod, the pins may be removed from under the trap-doors, and they will fall, disengaging whatever may be placed upon them. Suppose a piece of coin and a feather be placed upon one of these stages, supported by a projecting pin. This arrangement being made, let the brass cover be placed on the receiver, so as to be air-tight, and let the receiver be then exhausted by the pump. When a high degree of rarefaction has been produced, let the rod be turned by the handle at the top, so as to remove the pin from under the stage; the coin and the feather will be immediately let fall, and it will be observed that they will both descend at exactly the same rate, and strike the bottom at the same instant. This is the experiment commonly known as "the guinea and feather experiment."

The surgical process called cupping, consists in removing the atmospheric pressure from the part of the body submitted to the operation. A vessel with

an open mouth is connected with an exhausting syringe. The mouth is applied in air-tight contact with the skin, and by working the syringe, a part of the air is withdrawn from the vessel, and consequently the skin within the mouth of the vessel is relieved from its pressure. All the other parts of the body, however, being still subject to the atmospheric pressure, and the elastic force of the fluids contained in the body having an equal degree of tension, that part of the skin which is thus relieved from the pressure will be swelled out, and will have the appearance of being sucked into the cupping-glass. If the skin be punctured by lancets, the blood will thus be drawn from it in a peculiar manner.

That the presence of air is necessary for the transmission of sound, may be strikingly illustrated by the air-pump. A small apparatus, fig. 11, which, by

Fig. 11.

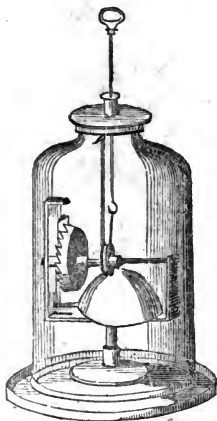

being drawn upward and downward alternately, causes a bell to ring, is placed on the pump-plate, and covered by a receiver with an open top. A brass cover, furnished with a sliding rod, is placed upon this. The sliding rod is terminated in a hook, which catches the apparatus, and by which it may be alternately raised and lowered, without allowing any air to pass into the receiver. The apparatus being thus suspended in the receiver by a silken thread, so that it shall not touch the bottom or sides, let the air be exhausted by the pump. When the rarefaction has been carried to a sufficient extent, let the rod be alternately raised and lowered, so that the bell shall ring. It will be found to be inaudible.

If the air be now gradually admitted, the sound will at first be barely audible, but will become louder by degrees, until the receiver is again filled with air, in the same state as the external atmosphere. In this experiment care must be taken not to let the sounding apparatus rest on the pump-plate, for it will then communicate a vibration to that, which will finally affect the external air and produce a sound.

THE CONDENSING SYRINGE.

The condensing syringe is an instrument by which a greater quantity of air may be forced into a vessel than that vessel contains when it has a free communication with the external atmosphere.

Let A, B, fig. 12, be a cylinder furnished with a piston P, which moves air-tight in it. Let C be a tube proceeding from the bottom, and furnished with a stop-cock. Let us suppose this tube to communicate with the receiver or vessel R, in which it is intended to condense the air. Let another tube, D, proceed from the cylinder, also furnished with a stop-cock. Let the piston be now drawn to the top of the cylinder, both stop-cocks being open. The receiver R, being in free communication with the atmosphere, will contain air of the same density and pressure as the external atmosphere. Let the stop-cock D be now closed, and let the piston be pressed to the bottom of the cylinder; the air confined in the cylinder below the piston will thus be forced through the tube C into the vessel R, while the piston is pressed against the bottom B. Let the stop-cock C be closed so as to prevent the escape of the air from the

Fig. 12.

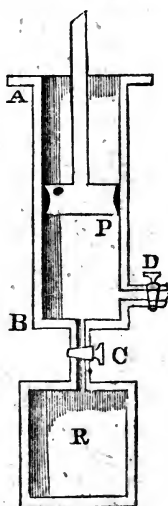

vessel R, and let the stop-cock D be opened, so as to allow a free communication between the cylinder A, B, and the external atmosphere. Let the piston be again drawn to the top of the cylinder. The cylinder will then be filled with atmospheric air of the same density as the external atmosphere. Let the stop-cock D be closed, and C opened, and let the piston be once more forced to the bottom of the cylinder; the contents of the cylinder will be thus again discharged and forced into the receiver R. Let the stop-cock C be again closed, and let the process be repeated. It is evident that at each stroke of the piston a volume of atmospheric air will be forced into the receiver equal to the dimensions of the cylinder A, B, and there is no limit to the degree of condensation, except that which depends on the strength of the receiver R, and the cylinder and tubes, and on the power by which the piston is urged.

After each stroke of the piston, the density of the air in R is increased by the admission of as much atmospheric air as fills the cylinder A, B, and therefore the density, as the process advances, receives equal increments at each stroke of the piston. Let us suppose that the receiver R has ten times the capacity of the cylinder A, B, and let us suppose that the elastic pressure of the air in R, at the commencement of the operation is expressed by the number 10. After the first stroke this pressure will be expressed by the number 11,

inasmuch as the quantity of air in R has been increased by one tenth part of its volume. After the second stroke the pressure will be expressed by the number 12. After the third by the number 13, and so on.

In the form given in practice to the condensing syringe, the necessity for manipulation by the stop-cocks here represented is removed. A silk-valve, such as that described in the exhausting syringe, is placed in the tube C, fig. 13, but opening downward. The neck of the receiver R is furnished with a stop-cock and a tube, which terminates in a screw. This screw is connected

Fig. 13.

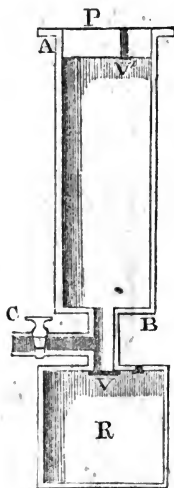

with a corresponding one proceeding from the bottom of the syringe. By this arrangement, the air is capable of passing through the silk-valve from the syringe to the receiver, but not in a contrary direction. A small hole is made through the piston, extending from the upper to the lower surface, and the silk-valve is extended across this hole on the lower surface, so that air is capable of passing through this valve to the cylinder below it, but not in a contrary direction.

Now let us suppose that the air in the receiver has the same pressure and density as the external atmosphere, and let the piston P be at the top of the cylinder, the air in the cylinder A, B, also having the same pressure and density as the external air. By pressing the piston toward the bottom of the cylinder, the air enclosed will become condensed, and by its increased pressure will open the valve V, and as the piston descends will be forced into the receiver R. When the piston has arrived at the bottom, all the air contained in the cylinder will be transferred into the receiver. It will be retained there, because the valve V, opening downward, will not permit its return. If the piston be now drawn up it will leave a vacuum below it when it begins to ascend, but the pressure of the atmosphere above will open the valve V', and the air rushing through will fill the cylinder as the piston ascends, and when the piston has arrived at the top of the cylinder, the space below it will again be filled with atmospheric air. By the next descent of the piston this air is forced into the receiver R as before, and so the process is continued.

It should be observed, that when the piston P is drawn to the top of the cylinder, the air which has passed into A B has not quite so great a pressure

as the external atmosphere. This arises from the valve V' requiring some definite force, however small, to open it. When the air which has passed into the chamber A, B , requires a pressure which is less than the atmospheric pressure, by an amount equal to the tension of the valve V' , then the excess of the pressure of the atmosphere over the resistance of the air contained in A, B will be insufficient to open the valve V' , and no more air can pass into the cylinder. It should also be observed, that the valve V being pressed upward by the elastic force of the air condensed in the receiver, requires a still greater pressure than this to open it, and therefore, before the valve V can be opened, the air enclosed below the piston P must always be condensed by the pressure of the piston in a higher degree than the air is condensed in the receiver. The observations which have been made respecting the limit of the operation of the exhausting syringe, arising from mechanical imperfections and other causes, will also be applicable here. However nicely the piston P and the cylinder in which it plays may be constructed, there will still be some small space remaining between it and the silk-valve V , when it is pressed to the bottom of the cylinder. Into this space the air contained in the cylinder may finally be condensed, and when the pressure of the air contained in the receiver becomes equal to the pressure of the air condensed into the space between the piston at the bottom of the cylinder and the silk-valve, the operation of the instrument must necessarily cease; for then the utmost degree of condensation which can be produced above the silk-valve V will be insufficient to open the valve, and therefore the syringe cannot introduce more air into the receiver.

THE CONDENSER.

The condenser has the same relation to the apparatus just described as the air-pump has to the exhausting syringe. The condenser consists of a receiver firmly and conveniently fixed, communicating by a tube with one or two condensing-syringes, which may be worked in the same manner as the exhausting-syringe described in the air-pump.

In the use of such an instrument, it is convenient to possess the means of indicating the degree of condensation which has been effected. For this purpose a mercurial gauge is used analogous to that which is applied to the air-pump. A bent tube, A, B, C , fig. 14, contains a small quantity of mercury,

Fig. 14.



S, B, S' , in the curved part. When the ends of the tube are open, and in free communication with the atmosphere, the surfaces S, S' , will stand at the same level. The extremity C is furnished with a stop-cock, by which a com-

munication with the atmosphere may be permitted or intercepted. The extremity A communicates by a tube with the receiver in which the air is to be condensed. At the commencement of the process, before any condensation has taken place, the stop-cock C is closed, and the air included between it and the surface S' has then the same pressure as the external atmosphere. The air in the receiver having also that pressure, the two surfaces S and S' necessarily stand at the same level. When the condensation of air in the receiver commences, the pressure on the surface S is increased, therefore that surface falls, and the surface S' rises. The pressure of the air condensed in the receiver will thus be balanced by the weight of the column of mercury between the levels S and S', together with the pressure of the air enclosed between S' and C. The pressure of the air enclosed in S' C is increased in the same proportion as the space S' C has been diminished. Now, as the original pressure of the air contained in this space was equal to the pressure of the atmosphere, it is always easy to find the pressure of the air reduced in bulk by increasing the amount of atmospheric pressure in the same proportion as the space S' C has been diminished. Thus if the air enclosed in the tube be reduced to half its original bulk, then the pressure it exerts will be double the atmospheric pressure. If it be reduced to two thirds of its bulk, then the pressure of the enclosed air will be the atmospheric pressure in the proportion of three to two, and so on. The pressure thus computed being added to the pressure arising from the column of mercury between the levels of the surfaces S and S', will give the whole pressure of the air condensed in the receiver.

Although the condenser is not without its use in experimental physics, yet it is an instrument far less important than the air-pump, to which it is so analogous. The cases are innumerable in which it is necessary to inquire what effect would take place in the absence of the atmosphere; but they are comparatively few in which it is necessary to investigate what effects would be produced under increased atmospheric pressure. We do not, therefore, think it necessary to enter into further details concerning the condenser.

EFFECTS OF LIGHTNING.

Classification of the Effects of Lightning.—*The sulphureous Odor developed by Lightning.*—Cases collected by M. Arago.—Nature of the Odor.—*Chemical Changes operated by Lightning.*—Nitric Acid formed by the Electric Spark; also Ammonia and Nitric Acid produced during Thunder Storms.—*Fusion and Contraction of Metals.*—Observations of the Ancients.—Franklin's cold Fusion.—Evidence against cold Fusion.—Masses of Metal melted by Lightning.—*Vitrefactions and Fulgurites.*—Heights at which Vitrefactions have been found.—Facts collected by M. Arago.—Fulminary Tubes, or Fulgurites.—Characters of Fulgurites.—Variations dependant on the Nature of the Soil where they are found.—Four Hypotheses to explain their Origin.—Their Formations in some Cases are recent.—Sand fused by artificial Heat into the State of the Fulgurites.—Artificial Fulgurites formed by the Electrical Battery.—The further Condition essential to explain the Origin of Fulgurites.—Recent Formation of Fulgurites observed.—*Mechanical Effects.*—Instances of the Mechanical Action of Lightning.—The Action is exerted in all Directions.—Inductive Action of Lightning.—M. Arago's Explanation of the Effect as due to Vaporization.—Objections to the Explanation.—Decompositions of the natural Electricities of Bodies.—Induction between the Clouds and the Earth.—Upward Flashes and Mechanical Effects.—Arago's Explanation.—*Magnetic Effects.*—To be explained in ELECTRO-MAGNETISM.—*Effects of conducting Bodies on Lightning.*—Conducting Properties of Metallic Bodies.—Lightning passing along Conductors in Preference to Non-Conductors.—Protection afforded by conducting Bodies.—Lightning selects conducting Bodies from among others.—Lightning Conductors should descend to a humid Soil.—Necessity of Continuity in a Conductor.—*Effects proceeding from the Surface of the Earth.*—Ascent or Ebullition of Water.—Inundations from subterranean Sources.—Mosaic Account of the Deluge; Analogous natural Phenomena.—Electrical State of the Atmosphere Favorable to the Process of barking Trees.—Effect of Thunder on fermented Liquors, &c.—Return Stroke reported by Brydone.—Theory of such Effects.—Flame appearing on the Ground.—Not extinguishable by Water.—Superposed Clouds not necessary to its Appearance.—Stationary luminous Appearance.—Lightning rising from the Earth like a Rocket.—Flames observed on exposed Points.—*Luminous Rain.*—Cases collected by M. Arago.—Luminous Dust.

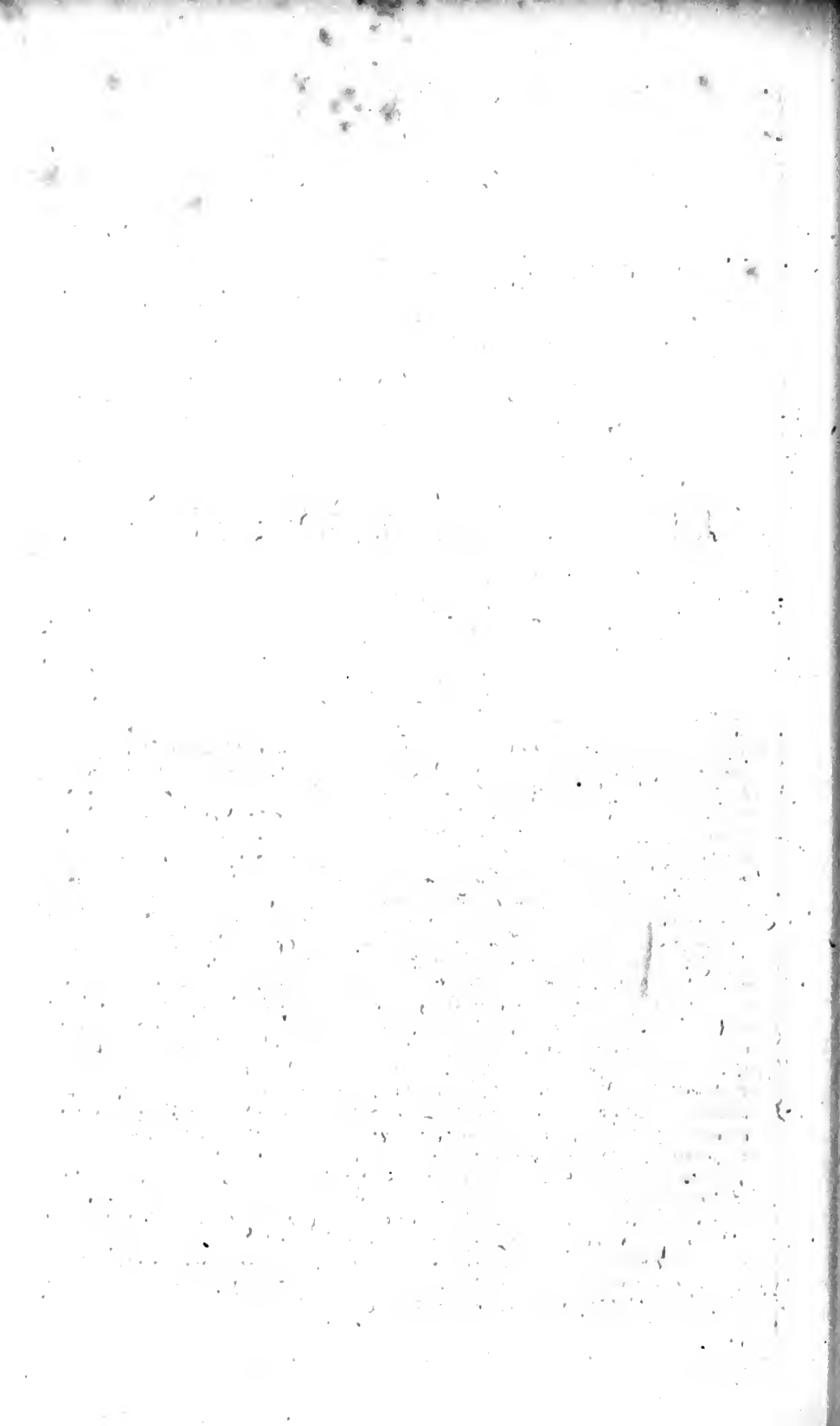

THE EFFECTS OF LIGHTNING.

THE effects which have been observed to attend the transmission of lightning through bodies which it strikes are so various, and apparently unconnected, that any classification of them is extremely difficult. I shall here adopt that which M. ARAGO has given. The chief effects of lightning may, then, be enumerated as follows :—

1. The diffusion of smoke occasionally, and a sulphureous odor almost invariably.

2. The production of chemical changes in the atmosphere itself, and in substances suspended in it.

3. The fusion of metals, and sometimes the contraction of their dimensions without fusion.

4. The vitrifications of earthy substances, and the formation of *fulgurites*, or thunder-tubes.

5. Mechanical effects in piercing, splitting, and transporting from place to place, the parts of bodies which it strikes.

6. The production of magnetic effects.

7. It passes along certain substances in preference to others, and in general its effects are dependant on the nature of the bodies it strikes.

8. The existence of a storm in the atmosphere is accompanied by a state of the surface of the earth beneath it in which lightning issues upward from it, and objects upon it are struck from below.

9. Luminous rain.

10. Rain, snow, and hail, falling in a storm, sometimes emit light when the drops strike each other, or strike the earth.

We shall consider these classes of effects in succession.

I. THE SULPHUREOUS ODOR DEVELOPED BY LIGHTNING.

The following instances have been collected by M. Arago :—

In a thunder-storm on the isthmus of Darien, Wafer, a surgeon, observed

that the air was infected with a sulphureous odor so strong as to check respiration, especially in the woods.

On another occasion, the same observer, crossing a hill after sunset, was overtaken by rain so terrible, that it seemed as though heaven and earth were coming together. There were loud claps of thunder, and the lightning was attended by an odor of sulphur so intense that the travellers were nearly suffocated by it.

Boyle, in his memoirs for a general history of the air, relates that in a thunder-storm which he encountered on the borders of the lake of Geneva, the air was impregnated with a sulphureous odor so strong, that a sentinel stationed near the lake was nearly suffocated.

Legentil witnessed a storm in the Isle of France, in February, 1771, in which a strong sulphureous odor was perceived.

On the 4th of November, 1749, in north latitude forty-two degrees and forty-eight minutes, and west longitude three degrees, the ship *Montague* was struck by lightning. It seemed as if the vessel was filled with burning sulphur.

On the 19th of April, 1827, the packet-ship *New York*, in north latitude thirty-eight degrees, and west longitude fifty-three degrees, was twice struck by lightning, being nearly five hundred miles from land. When first struck, the paratonnerre was not put up; yet the lightning, finding metallic bodies in its route, was conducted to the water, having done much injury to the vessel. The cabins were filled with a thick sulphureous smoke. When she was struck the second time, the paratonnerre was in its place, and no damage was done; nevertheless, various parts of the ship, and the ladies' cabin in particular, was filled with sulphureous vapor so thick that objects could not be seen through it.

On the 31st of December, 1778, at three o'clock, P. M., the India Company's ship *Atlas*, lying in the Thames, was struck by lightning, and a sailor was killed in the rigging. The ship for a moment seemed to be on fire, but in fact suffered no damage; a strong sulphureous odor was, however, diffused through it, which continued during the day and ensuing night.

On the 18th of July, 1707, lightning passed down the flues of six chimneys of a house in the *Rue Plumet* in Paris. A suffocating odor was diffused through the house.

On the 18th of February, 1770, the church of St. Kevern, Cornwall, was struck with lightning during Divine service, when the whole congregation were struck senseless. The church was filled with a suffocating sulphureous odor.

On the 11th of July, 1819, the church at Châteauneuf-les-Monstiers (*Basses Alfes*) being struck by lightning, was filled with a dense black smoke, which rendered it so dark that one could walk in it only by groping.

That the sulphureous odor developed by lightning arises from the actual presence of some vaporous matter, seems to be demonstrated by those observations in which an opaque cloudy vapor filled the rooms. Whether the matter diffused through the air is transported from the upper regions of the atmosphere by the lightning, or is developed by the action of the lightning on the bodies which it strikes, is still undecided. The possibility of matter being brought by the lightning from the clouds is countenanced by the phenomena of ball-lightning, and by the results of the investigations of M. Fusinieri. Although the odor diffused by lightning has been generally compared to that produced by the combustion of sulphur, some observers have assimilated it to phosphorus, and others to nitrous gas. If the last were its true description, an easy explanation of it would be obtained by considering the effects of electricity on the constituents of the atmosphere.

II. CHEMICAL CHANGES OPERATED BY LIGHTNING.

The experiment formerly alluded to, in which, by transmitting the electric spark through atmospheric air confined in a glass tube, a combination took place between a portion of its constituents and liquid nitric acid was formed, was due to the celebrated Cavendish. After the identity of lightning and electricity was established, no doubt was entertained that the same process took place in the atmosphere whenever lightning was transmitted through it. The direct demonstration of this important fact was made by Professor Liebig in 1827.

That philosopher submitted seventy-seven samples of rain-water, collected on different occasions, to the process of slow distillation. Of these samples, seventeen were collected during or immediately after thunder-storms. In the residue obtained from these seventeen, nitric acid was found in greater or less quantities, in combination with lime, or with ammonia. In fifty-eight of the other samples, these substances were not found; and in the remaining two, mere traces of nitric acid were just discoverable.

The formation of nitric acid in the atmosphere during thunder-storms suggests to philosophical observers various important objects of attention and inquiry. Under what circumstances of season, locality, height, and temperature, of the clouds, does the quantity of nitric acid thus formed vary? In tropical regions, where thunder-storms are phenomena of daily occurrence for entire months, is the quantity of nitric acid generated in the air sufficient to feed the natural veins of nitre found in certain localities where the absence of animal matter has rendered such formations a matter of great theoretical difficulty? The researches may also lead to the solution of the origin of the other substances, such as lime and ammonia, detected by Liebig in the pluvial waters falling from stormy clouds, and possibly for the sulphureous gas, of which the odor is so remarkable in places where lightning penetrates.

It would be a curious and interesting result of scientific investigation to demonstrate that the thunder of heaven elaborates in the clouds the chief ingredient of the counterfeit thunder which man has invented for the destruction of his fellows.

III. THE FUSION AND CONTRACTION OF METALS.

The power of lightning to effect the fusion of metals was observed by the ancients. Aristotle, Lucretius, Seneca, and Pliny, mention this property, but in a manner and attended by circumstances which, in the judgment of many, cast doubts on the truth of their statements. Aristotle mentions the copper on a shield being fused by lightning, while the wood which it covered was uninjured. Seneca states that the coin contained in a purse was fused, while the purse was unchanged; that a sword was liquefied, while the scabbard in which it lay was untouched; and that the iron points of spears being melted, flowed along the wood to which they were attached without burning it. Pliny relates that coins of gold, silver, and copper, sealed up in a bag, were melted by lightning, the bag not being burnt, nor the wax which sealed it softened.

If the fusion or liquefaction here referred to were understood to mean the complete fusion of the various pieces of metal mentioned by these several writers, there would be undoubtedly great difficulty in reconciling their statements with the known properties of matter. But if, on the other hand, partial or superficial fusion be meant, the well-ascertained results of modern observation corroborate this ancient evidence.

In 1781, M. D'Aussac and the horse on which he was mounted were killed

by lightning in the neighborhood of Castres. The blade of the sword which he wore was fused upon its surface at several places, while the scabbard containing it was not burned. This circumstance is not inconsistent with the known properties of bodies. The part of the blade not fused being a good conductor of heat, abstracted the heat from the fused part before it had time to burn the scabbard.

The statements of the ancient writers above quoted being taken literally, led Franklin to adopt the hypothesis of *cold fusion*. To admit the possibility of a wooden scabbard containing the heavy mass of incandescent liquid metal which must have resulted from the fusion of a Roman sword without being burnt, was impossible. He therefore proposed to remove the difficulty by admitting that lightning possesses the property of melting metals *without heating them*. This affords one of the many instances of the errors which arise from framing hypotheses to explain phenomena, the existence and nature of which are not accurately ascertained. The strict rules of philosophical reasoning required that Franklin should demonstrate as a *matter of fact* that the metal liquefied by lightning is actually cold while in the state of fusion.

That lightning fuses metals by raising their temperature to the point of fusion, is proved by the fact that metal fused by lightning falling in liquid drops on a wooden floor, or on the deck of a vessel, has burnt holes in the wood.

The fusion effected by lightning is not confined to that of thin wire or to the slight superficial fusion above mentioned. Considerable masses of metal have been on various occasions melted. When the power has not sufficient energy to produce fusion, the iron is often rendered incandescent and soft, and reduced to the state necessary for welding it. With a still more feeble power, it is only raised to a temperature more or less elevated. The following facts are collected by M. Arago in illustration of these principles:—

On the 20th of April, 1807, at Great Mouton, in Lancashire, a windmill was struck with lightning, which, having passed along a large iron chain, softened the links, so that by their own weight they were welded together, and the chain was converted into a rod of iron.

In June, 1829, the same occurrence took place in a windmill at Lothill, in Essex.

On the 5th of April, 1807, at Vezinet, near Paris, lightning struck a key, and softened it so that, by its weight, it was welded to its ring.

In March, 1772, lightning struck a bar of iron inserted at the most elevated part of the dome of St. Paul's cathedral, which was intended by the architect to be in metallic connexion with the pipe by which the water is conducted from the roof to the ground. This connexion was accidentally interrupted at a certain point, and *there* it was found that the bar had been rendered *red hot*. This bar was four inches broad, and half an inch thick.

In August, 1777, the weathercock of a tower in Cremona was struck by lightning, and the marble stones of the tower broken and scattered. The thunder was the most violent ever heard in that place. The iron rod of the weathercock, which was half an inch in diameter, was broken, but showed no mark of fusion.

On the 12th of July, 1770, lightning struck the house of Mr. J. Moulde, in Philadelphia, and fused a rod of copper six inches long, but of unascertained diameter.

In 1754, the steeple at Newbury, in the United States, was struck by lightning, after which it was examined by Franklin, who found that the lightning had passed along an iron wire twenty feet long, and about the thickness of a knitting-needle, which it reduced to smoke. The course of the wire along the walls and floors was marked by a black line, like that left by a train

of gunpowder which has been fired. In this case the wire was probably burned. Another wire, in the same tower, of the thickness of a goosequill, transmitted the lightning without being fused.

When Captain Cook was anchored in the roadstead of Batavia, his ship was struck by lightning, which produced a shock like that of an earthquake. An iron wire, a quarter of an inch in diameter, extending from the mast-top to the water, appeared for a moment to be on fire. No damage was sustained.

On the 18th of June, 1782, lightning struck the house of Mr. Parker, at Stoke-Newington, near London, and having passed down one of the pipes, provided to conduct the fluvial waters from the roof, from that it passed into a bed-chamber, where it followed the course of a wire which connected a cord at the bedside with a night-bolt at the door, by which a person could bolt or unbolt the door without leaving the bed. Such a bolt passes through two rings attached to the doorframe, which, in this case, served as a gauge for the length of the connecting wire. After the lightning had passed along it, the wire was found so much *shortened* that the bolt could not be let fall.

Wire extended between two fixed points is often broken by lightning, which may be explained by the contraction just mentioned, and the fixed points not allowing the wire to yield.

IV. OF VITRIFICATIONS AND FULGURITES.

As evidence of the heights at which the presence of lightning has been manifested, the vitrifications observed in certain places have been already mentioned. Saussure, in 1787, observed these effects on the Dôme de Gouté, one of the summits of Mont-Blanc. Ramond observed them on several summits of the Pyrenees, especially the Pic du Midi and Mont-Perdu, and on the rock Sana-doire, in the Puy-de-Dôme. Humboldt and Bonpland found similar appearances on the rock El Frayle, at the top of Teluca, one of the Cordilleras, near the city of Mexico.

These several observers merely *saw* the vitrifications; they *inferred* their cause by the form of reasoning called, in logic, a disjunctive syllogism; that is, by severally rejecting every other possible cause, they concluded that lightning must have been the true one. That a question so important may not rest solely on such negative proof, M. Arago has collected the following facts in support of it:—

On the 3d of July, 1725, at Mixbury, in Northamptonshire, lightning struck on an open field, and killed a shepherd and five sheep. Close to the body of the man were found two holes, five inches in diameter and forty inches deep. Near the bottom of one of them was found a very hard stone, measuring ten inches long, six inches broad, and four inches thick, with its surface *vitrified*.

In the year 1750 lightning struck the tower of Asinelli, at Bologna, and did some injury to it. Beccaria, who examined it, found the bricks at the place, where the lightning struck *vitrified*.

On the 3d of September, 1789, lightning struck an oak in the park of Lord Aylesford, and killed a man who sought shelter under it. This person carried a walking-stick, which apparently conducted the lightning to the ground, for at its point was found a hole five inches in depth and two inches and a half in diameter; and below this, to a depth of twelve inches, were found marks of vitrification.

The fact last mentioned leads to the consideration of *fulminary tubes*, or *fulgurites*, of which it may almost be regarded as an example.

The tubes were first discovered in 1711, by Heman, a shepherd, at Massel, in Silesia. Specimens of them were sent to the mineralogical museum at

Dresden, and are still preserved there. Nearly a century elapsed before they were seen again, when, in 1805, Dr. Hentzen found them in Paderhorn, commonly called La Senne. This philosopher first assigned their origin. They have been since found in great numbers at Pillau, near Königsberg; at Nietleben, near Halle upon Saale; at Drigg, in Cumberland; in the sandy country at the foot of Regenstein, near Blankenburg; and in the sands of Bahia, in Brazil.

At Drigg the fulgurites are found in hillocks of moveable sand, about forty feet high, close to the sea. At La Senne they are usually discovered at the brow of hills of sand about the same height; sometimes also in a cavity, formed like a basin, one hundred feet in circumference, and fifteen feet deep.

Fulgurites are usually hollow tubes. At Drigg their diameter is generally two and one fourth inches. Those at La Senne vary from one fiftieth of an inch to half an inch in diameter, and contract as they descend, terminating frequently in a point. The thickness of their sides varies from the fiftieth of an inch to an inch. These tubes usually descend in the vertical direction, being occasionally, however, inclined at an angle of 40° to the horizon. Their total length sometimes amounts to above thirty feet. Numerous transversal fissures divide them into fragments, the lengths of which vary from half an inch to six inches. The sand by which they are surrounded dries and falls off after a lapse of time, and these fragments are then seen on the surface of the ground, the sport of the wind.

Most commonly, in clearing away the surrounding sand, the fulgurite is found to consist of a single tube. On following it to a certain depth, this is divided into two or three branches, each of which again divides into small lateral ramifications, varying from one inch to twelve inches in length. These final ramifications are conical, and terminate in points, which are gradually inclined downward.

The interior surface of the tubes is coated with a perfect and very brilliant glass, resembling vitreous opale, or *hyalite*. It cuts glass and strikes fire with steel. Whatever be the form of these tubes, they are always surrounded by a crust composed of grains of *quartz* agglutinated together. This crust is sometimes round; it is oftenest like the bark of a stump of an old birch-tree. The interior and exterior surfaces correspond in form, as if the tube were soft and flexible, and acquired hardness after being bent.

When examined with a microscope, the exterior crust presents marks of fusion. At a certain distance from the centre of the tube the grains or globules acquire a reddish tint. The color of the material of the tube, and especially of the exterior parts, depends on the nature of the sandy soil in which it has been formed. In the superior strata, which consists of common soil, the exterior of the tube is usually black; deeper, it is a yellowish gray; and deeper still, a grayish white. Finally, where the sand is pure and white, the tube exhibits nearly perfect whiteness.

Such being the appearances presented by *fulgurites*, the question is presented: Whence do they originate, and by what natural process have they been formed? Four hypotheses were proposed to explain them: 1. They might have been incrustations formed round roots, which disappeared after the operation; 2. They might be stalactites or other mineral formations; 3. They might be cells belonging to ancient marine animals of the worm species; 4. They might be produced by lightning penetrating the ground.

The first three of these hypotheses include, as a necessary condition, the formation of the fulgurites at an epoch more or less remote from the present time. If it can be shown, then, that, whatever be their origin, it must, in some cases at least, be recent, these hypotheses must be severally rejected. The

phenomena at Drigg are conclusive as to the recency of the formation of the fulgurites, and are therefore fatal to these hypotheses.

The hillocks of sand in which the fulgurites at Drigg are formed are *shifting*, being subject to constant change by the wind. The tubes in them must, therefore, be of recent formation.

But it is necessary to show that the state in which the sand is found in the internal and external coating of the tube, as well as in every part of its thickness, *can be* produced by intense heat.

This has accordingly been done. The sand in which the tubes have been formed has been exposed to the action of various degrees of heat by means of the blowpipe, and effects have been produced which correspond with the state of the tubes, and prove that intense heat *can* produce the observed effects.

Since we have in the electricity of the machines another lightning infinitely less in its degree, but still the same in *kind*, a further corroboration of this hypothesis would be obtained, if by means of this artificial lightning artificial fulgurites could be formed. MM. Savart, Hachette, and Beudant, transmitted the charge of a powerful electrical battery through a mass of glass reduced to powder, and obtained fulgurites an inch in length, and having an external diameter varying from an eighth to a tenth of an inch, with an internal diameter of about the twenty-fifth of an inch.

One step more is necessary to establish the origin of fulgurites. This step would consist in producing an example of the lightning being actually seen to strike the ground where a fulgurite was afterward found, none having been there before. This step is not wanting.

Dr. Fiedler, who has published a work in German on fulgurites, supplies the following facts:—

An apothecary of Frederichsdorf was brought to two men who had been struck with lightning. He found in the ground where they lay two fulgurites, like those of La Senne.

On the confines of Holland, in a sandy country, a shepherd, after having seen the lightning strike a hillock of sand, found in the very point where it struck a fulgurite.

On the 13th of July, 1823, lightning struck a birch-tree near the village of Rauschen, in the province of Samlande, on the shores of the Baltic, and at the same time set fire to a juniper-bush. The inhabitants ran to the spot, and found near the tree two narrow and deep holes. One of them, notwithstanding the cooling effect of the rain which was falling, was hot to the touch. Professor Hagen, of Königsberg, examined these holes, and found them, after excavation, to have all the usual characters of fulgurites.

The origin of fulgurites may then be considered as demonstrated.

V. MECHANICAL EFFECTS.

The mechanical effects of lightning, seen in piercing solid bodies with holes, in splitting them in pieces, and in projecting their fragments (sometimes of enormous weight) to great distances, are so well known, and so generally admitted, that it will be needless to multiply instances in proof of it; but a circumstantial statement of some remarkable cases of this kind may throw light upon the manner in which the electric fluid acts.

In the autumn of 1778 lightning struck the house of Casselli, an engineer, at Alexandria. It did no damage, but pierced the panes of glass in the windows with several small holes about the sixth of an inch in diameter. Small cracks in the glass diverged from these holes as centres.

In August, 1777, lightning struck the steeple of the parish church of St.

Sepulchre at Cremona, broke the iron cross which surmounted the tower, and projected to a distance the weathercock, which revolved under the cross, and which was made of copper, tinned, and coated with oil-paint.

This weathercock was found to have been pierced with *eighteen holes*, nine of which were very prominent on one side, and the other nine on the other. As there was no appearance of more than one stroke of lightning, all these holes must be supposed to have been pierced at once. The position of the holes are such as would have been produced by blows imparted simultaneously in opposite directions on parts of the metal nearly contiguous, and the inclination of the beards or projecting edges of the holes on one side correspond exactly with those on the other, the directions of all the eighteen beards being parallel.

On the 3d of July, 1821, lightning struck a house at Geneva, and pierced the tin which covered a part of the roof with several holes, leaving evident marks of fusion. One piece of tin in particular, which covered the angle made by a chimney with the surface of the roof near it, was pierced with three nearly circular holes, about an inch and three quarters in diameter, and about five inches apart, measured from centre to centre. The metal at the edges of these holes was bent, as it would have been by a force bursting through it in one direction or the other. The edges of the two holes were bent on contrary sides.

On the night between the 14th and 15th of April, 1718, the church of Gouesnon, near Brest, was struck by lightning with such force that it shook as if by an earthquake. The stones of the walls were projected in all directions to a distance of from fifty to sixty yards.

The lightning which formerly struck the château of Clermont, in Beauvoisis, made a hole twenty-six inches wide and the same depth in the wall; the date of the building of which was so far back as the time of Cæsar, and which was so hard that a pickaxe could with difficulty make any impression upon it.

On the night between the 21st and 22d of June, 1723, lightning struck a tree in the forest of Nemours. The trunk was split into two fragments, one seventeen and the other twenty-two feet long. These fragments, so heavy, that one of them would require the combined strength of four men, and the other that of eight men, to lift it, were, nevertheless, projected by the lightning to the distance of about seventeen yards.

In January, 1762, lightning struck the church of Breag, in Cornwall, the southwest pinnacle of the tower of which it destroyed. A stone, weighing one hundred and seventy pounds, was projected from the roof of the church to a distance of sixty yards in the direction of the south. Another fragment of stone was, projected to the north to a distance of four hundred yards. A third was projected to the southwest.

About the middle of the last century, a rock of micaceous schist, measuring 105 feet long, 10 feet wide, and about 4 feet thick, was struck by lightning at *Funzie in Fellar*, in *Scotland*, and was broken into three principal fragments, not counting smaller pieces. One of these fragments twenty-six feet long, ten feet wide, and four feet thick, had been merely inverted in its position. Another twenty-eight feet long, seven feet wide, and five feet thick, was projected over the hill to a distance of fifty yards. The remaining piece, forty feet long, was projected in the same direction, with still greater force, and fell in the sea.

On the 6th of August, 1809, at *Swinton*, about five miles from *Manchester*, lightning struck the house of Mr. Chadwick, at 2, P. M. A sulphureous vapor immediately filled the house. The external wall of a building erected against the house as a coal-shed, was torn from its foundations, and raised in a mass. It was transported, maintaining its vertical position, to some distance from its

original place; one of its ends was transported nine and the other four feet. This wall thus raised and transported, was composed of seven thousand bricks, which, independent of the mortar by which they were cemented together, would have weighed about twenty-six tons. This wall was eleven feet high and three feet thick, and its foundation was about a foot below the level of the ground. Above this coal-shed was a cistern, which, at the time of the phenomenon, contained a quantity of water, and the shed contained about a ton of coals.

If these mechanical effects could be explained by supposing them to be produced by the moving force of the electric fluid itself impinging on the bodies which are struck, no difficulty would arise from the extreme lightness and tenuity of the electric fluid, for the momentum of a body depends as much on its velocity as on its weight, and however subtle the electric fluid may be, it is possible to imagine a velocity by which it may acquire any proposed moving force. There are, however, circumstances among the observed effects, which cannot be explained by the mere impact of any fluid upon the bodies struck. One of those is, that the fragments of bodies struck by lightning are usually dispersed *in all directions*, and this is the case even when the fragments are large and heavy masses. If the pinnacle of the church at Breag had been struck by the mechanical force of a body moving in a determinate direction, it could not have happened that two large and heavy masses of stone would be driven, one to a distance of sixty yards south, and the other four hundred yards north. If the circumstances attending bodies struck by lightning be attentively considered, it will be apparent that they are such as would be produced by a force suddenly called into action, and directed outward from the internal dimensions of the body, so as to *burst it in pieces*. If the approach of lightning could be shown to be capable of producing, instantaneously, within a body, a highly elastic fluid, such a fluid, in exerting an outward pressure, would burst the body, exactly as the explosion of gunpowder forces out the ball, or failing to do so, bursts the gun.

From what has been established respecting the action of free electricity, it is evident that lightning will decompose the natural electricities of any bodies which it approaches, drawing toward itself, the fluid of its own name, and repelling to the more remote parts the contrary fluid. If the body be a conductor, this decomposition will take place, and the free electricities of opposite names will be accumulated on opposite sides of it, and when their tensions exceed that of the atmosphere, they will escape. If it be not a conductor, then the natural electricities, being forced asunder by the inductive action of the lightning, may produce the effect of a confined elastic fluid, and a separation of the parts of the body will be the consequence.

The hypothesis proposed by M. ARAGO, to explain the mechanical effects of lightning refers their origin to the water, or other fluids contained in the pores of the body on which the lightning acts. Lightning is proved by observation to evolve heat sufficiently intense to reduce metallic wires suddenly to a state of incandescence. M. Arago argues, that it may therefore be reasonably inferred that it may also produce a like effect on the minute threads of water which pervade the interstices of certain bodies. By the experiments of M. Dulong and Arago, the elasticity of steam at the temperature of 500 degrees Fahr. amounts to 45 atmospheres. But this temperature is much less than that of red-hot iron. It may therefore be inferred that any small portions of water contained in the pores of bodies, which suddenly acquire as much heat as would render iron red-hot, must acquire an elastic force so enormous as to be capable of producing any of the mechanical effects which have ensued from lightning. In foundries, where a small quantity of water has accidentally been

deposited in the mould in which the liquid metal is poured, the most terrible explosions have taken place at the moment the metal comes in contact with the water. Admit that humidity is found in the fissures and cells of the blocks of stone which form a building, and if the thunder strikes this stone, the sudden production of vapor within it would break it, and its fragments would be projected in all directions. In like manner, the sudden formation of vapor in the ground beneath the foundations of the walls of a house would be sufficient to raise the walls in a mass, and transport them to a distance. The circumstances attending the action of lightning on trees are still more easily explicable by M. Arago's hypothesis, since the sap and vegetable juices, being placed in lines parallel to the direction of the fibres, the vapor which would be formed would split them in pieces exactly in the manner in which trees are observed to be split by lightning.

This explanation, ingenious as it is, is not free from objection. That water may be suddenly and strongly heated by lightning when the body which contains it is a conductor of heat, may be admitted. But when lightning strikes a large block of stone, the heat must penetrate its dimensions before it can reach the water which may be contained within them; but stone being almost a non-conductor of heat, its surface might be fused, while its internal dimensions would not suffer a sensible elevation of temperature, especially when the stone is exposed to the source of heat only for an instant. Wood is also a bad conductor of heat, yet M. Arago's hypothesis seems to require the admission, that a tree struck by lightning is heated sufficiently to produce aqueous vapor of enormous elasticity, without producing the combustion, or even the carbonization of the wood itself. The soil, or earthy matter at the surface of the ground, is also almost a non-conductor of heat, yet M. Arago requires the admission, that the lightning acting on it produces a vapor from water below it of sufficient pressure to lift the wall of a house and project it to a distance.

None of these difficulties appear to attend the supposition that the natural electricities of non-conducting bodies, being forcibly decomposed by the proximity of the electric fluid which forms the lightning, and which may be conceived to have an almost infinite intensity, their violent separation resisted, as it would be, by the non-conducting quality of the bodies themselves, would be attended with all the effects which M. Arago ascribes to the sudden formation of vapor, without any of the difficulties or objects which are involved in that supposition.

If the electricity projected from the thunder-cloud be supposed to be positive, that of the ground which it approaches will necessarily be negative, and more intensely negative the more intensely positive is the electricity coming from the cloud and the more nearly it approaches the ground.

Whatever hypothesis may be adopted to explain the facts, the terms *ascending* and *descending* lightning may be allowed, if they be understood to refer to the direction in which the electricity is propagated, as manifested by its effects. Facts are not wanting to indicate the progress of the electric influence *upward*.

On the 24th of February, 1774, lightning struck the steeple of the village of Rouvroi, to the northwest of Arras. A pavement composed of large blue stones, which was laid under the steeple, was *violently raised upward*.

In the summer of 1787, lightning struck two persons who took refuge under a tree near the village of Tacon in Beaujolois. Their hair was *driven upward and found upon the top of the tree*. A ring of iron which was upon the shoe of one of these persons was found afterward *suspended on one of the upper branches*.

On the 29th of August, 1808, lightning struck a small building near the hospital of Salpêtrière in Paris. A laborer who was in it was killed, and, after the event, the pieces of his hat were found incrustated on the ceiling of the room.

When trees have been barked by lightning, it frequently happens that the bark is stripped from the base of the trunk *upward* to a certain height, and the upper part of the tree is untouched. This occurred with several trees in the Champs Elysées at Paris, in a storm which took place in June, 1778.

The leaves of trees which have been struck by lightning often exhibit the effects of heat on their lower surfaces, but not at all on the superior surfaces.

All these effects M. Arago thinks are capable of being explained by the vapor of water issuing upward after being evolved by the lightning acting on water contained in the ground.

They are also capable of explanation by the escape of negative electricity from the ground upward.

VI.—MAGNETIC EFFECTS.

This class of effects is so well known, and so perfectly explained by the principles established in ELECTRO-MAGNETISM, that it will not be necessary to devote any space here to the enumeration of instances of them.

VII.—EFFECTS OF CONDUCTING BODIES ON LIGHTNING.

Although the properties of metallic substances, and other conductors, in reference to lightning, are capable of being inferred by analogy from the principles of common electricity, yet the difference of the intensity of the atmospheric electricity in storms, and the artificial electricity of the machines, is so enormous that it cannot be without great utility to record the circumstantial statements of those effects of lightning which illustrate the influence of conductors when affected by electricity of a tension so much greater than any which can be obtained in ordinary experiments.

The unvarying preference which electricity gives to conductors over non-conductors in the selection of its route, is strikingly illustrated in the following narrative, addressed to the abbé Nollet, soon after the discovery of the virtue of conductors by the count *Latour Landry*.

On the 29th of June, 1763, in a violent thunder-storm, lightning struck the steeple of the church of Antrasme, near *Laval*. It entered the church and fused or blackened the gilding of the frames and borders of particular niches. It blackened and scorched (*demi-grillée*) the cruets (*burettes*), which lay in a small cupboard, and, finally, it pierced two deep regular holes like those of an auger in a marble closet where the church plate was kept, and which was placed in a niche formed in a wall of sandstone.

These damages were repaired; the gilding was restored, the holes stopped, and the painting renewed. On the 20th of June, 1764, lightning again struck the steeple. It entered the church at the same place; blackened the gilding which it had blackened before; fused that which it fused before; extended its damage to precisely the same limits, without exceeding them; blackened and scorched (*grillée*) the cruets; and, finally, reopened the two holes in the marble closet.

The protection afforded by conductors to surrounding non-conductors, and the damage done by lightning in forcing its way to the former, and escaping from them through the latter, is proved by the following instances:—

When lightning struck the tower of *Newbury*, in 1754, on the occasion formerly mentioned, it first destroyed the superior part, which consisted of a pyramid of carpentry about seventy feet high. Having scattered this mass of woodwork it encountered a metallic wire which descended through the tower to a point about twenty feet lower. It fused this wire in several places, but

the carpentry surrounding it suffered no damage, although the flash had by no means expended its force, as was proved by its effects in descending lower.

Arriving at the lower extremity of this wire the lightning again passed through the carpentry, which it damaged considerably; and such was its intensity, that when it reached the ground it tore up several of the foundation stones of the building, and projected them to a considerable distance.

The power of metals and similar conductors to give a free passage to the electric fluid, is not the only quality from which they derive importance in reference to atmospheric electricity. When lightning comes into the neighborhood of masses of metal, whether they be exposed or covered by non-conductors, the lightning will force its way to them, bursting through any intervening non-conducting bodies, and fracturing or otherwise damaging them. This may be easily explained by the known effects of induction. The inductive action of the lightning, decomposing the natural electricities of the metal, attracts the fluid of the same name to the end nearest to it, and is reciprocally attracted by it. The energy of this attraction may be sufficient to produce the effects which are observed. Lightning will also desert a smaller metallic conductor and rush to a larger one, breaking its way through intervening non-conductors. The principle of induction is equally applicable to the explication of this effect.

Lightning having struck a large rod of iron placed on the roof of the house of Mr. Raven, in Carolina, U. S., passed along a brass wire which was carried down the external surface of the wall, and connected with a bar of metal which was sunk in the ground. In its descent the lightning fused all that part of the wire extending from the roof to the first floor above the level of the ground, without damaging the wall against which the wire was attached. At the height of the first floor it took another course, deserting the wire, bursting through the wall, in which it made a large aperture, and entered the kitchen. The cause of this singular deviation at right angles to its former course became manifest, when it was found that a gun standing on its stock rested with its barrel against the kitchen wall, exactly at the place where the lightning forced its way through it. The lightning passed along the barrel of the gun without injuring it, breaking, however, the stock, and damaging the hearthstone near it.

In the night between the 17th and 18th of July, 1767, lightning struck a house in the *Rue Plummet*, in Paris. Several frames were suspended in one of the rooms, one of which only was gilt; this one it attacked, neglecting all the others. A tin lantern, and two thin glass bottles, lay upon the table; it demolished the lantern, but spared the bottles. In another room was placed an iron stove; this was destroyed, while everything else in the room was uninjured. In another room was a wooden chest containing several articles made of iron; the chest was broken, and the iron articles presented evident marks of fusion, yet half a pound of gunpowder, which was contained in an open powderhorn which lay among these articles, was not fired.

On the 15th of March, 1773, lightning struck the house of Lord *Tilney*, at *Naples*. A large assembly, consisting of not less than five hundred persons, happened to be in the house at the time, among whom were SAUSSURE and Sir WILLIAM HAMILTON. Almost all the gildings of the rooms, the cornices of the ceilings, the rods supporting the drapery of the furniture, the gilding of chairs and sofas, the gilded frames of the doors, and the bell-cords, were fused, blackened, or scaled off. As usual, the greatest effects were produced wherever the continuity of the conducting matter was interrupted. It is certain that lightning sufficiently powerful to fuse wire would kill a man. In this case, therefore, lightning sufficiently intense to produce death traversed nine rooms, containing five hundred persons, without injuring any one, its

course being confined to a series of accidental conductors supplied by the walls and furniture.

In 1759 the detachment of French soldiers which conducted Captain Diben a prisoner of war at *Martinique*, took shelter from rain under the wall of a small church which had neither tower nor steeple. Lightning struck the building, killed two of the soldiers leaning against the wall, and made a breach in the wall, immediately behind them, four feet high and three feet wide. On examining the place, it was found that within the chapel, at the place of the breach, a collection of massive bars of iron were placed, intended to support a monument. Those soldiers who were not placed opposite to the iron were uninjured.

On the 10th of June, 1764, lightning struck the steeple of *St. Bride's* church, in *Fleet street, London*, and did great damage. The weathercock was first struck; from that the lightning descended along a bar of iron buried among the massive stones of which the steeple is built. This bar was two inches in diameter, and twenty feet long, and its lower end was let into a cavity five inches deep in a stone, and secured there by lead. The gilding on the cross and weathercock was partly destroyed, and all that remained was blackened. The soldering in several places was fused. Along the descending bar no trace of the fluid was discoverable; but at its lower extremity, where the continuity of the metal was broken, were marks of violent effects. The stone in which the end of the bar was inserted was broken in pieces: a large breach was made at the same place in the side of the steeple. The lightning thence seemed to have descended by leaps from one iron cramp to another immediately below it. It did not, however, confine its path merely to the descending direction: wherever iron cramps were inserted within the masonry, to bind the blocks of stone together, the fulminating fluid penetrated and left its marks. In fine, the stones were split, broken, pulverized, displaced, and launched to a distance like projectiles, in the neighborhood of the extremities of all the bars of iron used in the construction of the building.

In the case of the house struck in 1767, in the *Rue Plummet, in Paris*, already mentioned, a remarkable example of the influence of a hidden mass of iron was offered. The only injury done to the exterior of the building was the entire demolition of the entablature, behind which was disclosed a number of large pieces of iron used in its construction.

It is evident from these instances, that so long as a continuity of metal is afforded, no damage is done by lightning. But a continuity of any *conducting* matter ought to produce the same effect.

If the metal be continued to the ground, and the ground be sufficiently humid to afford a free passage to the electricity, no injurious effects ensue, and the lightning passes quietly into the crust of the globe. But if the ground be dry, it becomes a non-conductor, and the electricity escapes with an explosion.

On the 28th of August, 1760, lightning struck a bar of iron erected on the roof of the house of Mr. Maine, in the United States, and partially fused it. This bar descended to the ground, which it penetrated to some depth, but the soil not being sufficiently humid, the lightning produced an explosion, broke up the ground, and damaged the foundations of the house.

On the 5th of September, 1779, at *Manheim, on the Rhine*, lightning struck an iron bar raised on the roof of the hotel of the ambassador of Saxony, by which it was conducted along the roof and walls of the building to the ground. The ground being dry, it quitted the bar with an explosion which produced a vortex of sand which was witnessed by several persons, and of which evident traces remained.

When the continuity of the conductor is broken, and the lightning escapes

by an explosion, the whole conductor is rendered luminous, which never happens when the conductor is uninterrupted.

Lightning struck the conductor on the house of Mr. West, in *Philadelphia*, and the place where its lower extremity met the ground, at about five feet below the surface, being dry, the lightning escaped by explosion. A heavy shower fell at the moment, which having moistened the pavement, the whole surface of the ground for several yards around the conductor seemed to be on fire.

VIII.—EFFECTS PROCEEDING FROM THE SURFACE OF THE EARTH.

The class of appearances now to be noticed require the more detailed and especial description, inasmuch as they are more rarely subjects of observation, and many of them are difficult to be connected with the known principles of electricity.

When storms are breaking in the heavens, and sometimes long before their commencement, and when their approach has not yet been manifested by any appearances in the firmament, phenomena are observed, apparently sympathetic, proceeding from the deep recesses of the earth, and exhibited under very various forms at its surface. Instead of recounting this extraordinary class of physical facts in general terms, which from their nature must want that precision so desirable in such descriptions, and which are always liable to inaccuracy when a legitimate theory of the phenomena is wanting, we shall here state the particular facts collected by the active zeal of M. Arago on this interesting subject.

DAVINI wrote to VALLISNERI that he had observed, near *Modena*, a fountain whose waters were clear or turbid according as the sky was clear or clouded. Vallisneri himself states that he observed that the salt marshes of *Zibia*, *Queveola*, *Cassola*, and also in the duchy of *Modena*, and the sulphur springs, announce an approaching storm before there is any appearance of it in the heavens, by a sort of ebullition, and by subterranean noises like that of thunder, and sometimes even by actual thunder.

TOALDO relates that in the hills of *Vicentino*, at a little distance from the parish church of *Molvena*, there is a fountain called by the people of the place *Bifoccio*, because it has two sources. When a storm is approaching, this fountain, even after a long drought and at times when it is completely dry, gushes out suddenly and fills a large canal with turbid water, which spreads over the adjacent valleys.

At two miles from the source of this fountain, near the parish church of *Villa-raspa*, in the court-yard of M. Joseph Pigati, of *Vicenza*, is a deep well which, on the approach of a storm, boils with such violence as to terrify the inhabitants of the place.

It is stated in the journal of *Brugnatelli*, that, on the 19th of July, 1824, immediately after a storm, the waters of the lake *Massaciuccoli*, in the duchy of *Lucca*, became as white as if a quantity of soap had been dissolved in them. This appearance continued during the following day, and on the next day multitudes of fish of every size were found dead upon its banks.

No one who has witnessed the local floods which take place in storms of thunder and rain can fail to be struck with the inadequacy of the quantity of rain, however highly estimated, which can fall within given limits, to account for the enormous quantity of water discharged over plains and through valleys from the higher regions. Direct evidence is not, however, wanting to prove, that in such cases the internal waters of the earth are often discharged through temporary fissures, which break open in the sides of hills and other places. An occurrence of this kind took place in *Yorkshire*, in the month of June,

1686, when two villages were entirely destroyed by the flood. During a storm an immense chasm was opened in the side of a hill, and a mass of water issuing from it contributed much more than the rain to the flood which ensued.

In October, 1755, a sudden inundation produced immense ravages in Piedmont; the Po overflowed its banks. This disaster was preceded by horrible thunder; and the unanimous opinion of all who witnessed the occurrence, including the celebrated Beccaria, who left the record of it, was, that its chief cause was an immense volume of subterranean water, which, during the storm, suddenly issued from openings which it made for itself in the bosom of the hills.

It is impossible to contemplate these phenomena without calling to mind the Mosaic record of the flood. In that record, the source of the waters by which the earth was submerged is stated not to arise solely from the rain which fell from the clouds—

“In the six hundredth year of Noah’s life, in the second month, the seventeenth day of the month, the same day were all the fountains of the great deep broken up, and the windows of heaven were opened.”—Gen. vii. 11.

The breaking up of the fountains of the great deep, as distinguished from the opening of the windows of heaven, either has no meaning, or must be taken to express the breaking out of the subterraneous waters by clefts and fissures in the crust of the earth. That the expressions are not accidental tautology or pleonasm, is proved by their repetition in the next chapter, where the termination of the flood is described :—

“And God remembered Noah, and every living thing, and all the cattle that were with him in the ark; and God made a wind to pass over the earth, and the waters assuaged. The fountains, also, of the deep, and the windows of heaven, were stopped, and the rain from heaven was restrained.”—Gen. viii. 12.

The rupture of the crust of the globe by the influence of the electricity of the atmosphere, exerted upon large masses of subterraneous water, would not be inexplicable, if it could be shown as a matter of fact that the same influence is capable of producing a swelling and heaving upward of the unconfined waters of the ocean. Incontestable and recent evidence of this fact is not wanting.

In April, 1827, the packet-ship *New York*, between that port and Liverpool, was assailed by a violent storm, in which the sea appeared to boil as if a thousand submarine volcanoes were in a state of eruption at its bottom. Three columns of water were seen which arose toward the clouds, falling back in foam, then rising anew to fall back again.

On the *Mont d’Or*, in Auvergne, is an ancient building in the middle of which is a cistern hewn out of a single block of stone called *Cæsar’s cistern*. In the bottom of this are two holes communicating with a spring through which water rises with a motion and noise like that of ebullition. Frequent observations have been made on this spring by Dr. Bertrand, who states that it increases considerably when the weather is stormy. The increase of noise which attends it is known among the inhabitants of the valley as a presage of coming storms; it is a sign which they say never deceives them.

The celebrated *Duhamel du Monceau* states that silent lightnings, unaccompanied by wind or rain, called *heat-lightnings*, have the property of breaking the ears of corn. Farmers are well acquainted with this fact. On the 3d September, 1771, *Duhamel* himself witnessed this fact; on the morning of that day there was much lightning, and he afterward found that all the ears of corn which were ripe were broken off at the nearest knot. The only ears which remained standing were the green ones.

These and similar effects indicate an influence emanating from the ground. Such effects are not confined to corn, but probably extend to all vegetable sub-

stances. The following fact, as stated in the *Bibliothèque Britannique* of Geneva, for the year 1796, supplies an example of this :—

A wood of oak situated on an eminence two leagues from Geneva, was barked in May, 1795. This operation can only be effected in the season of the year when the sap, moving between the wood and the bark, diminishes sufficiently the adherence of the latter to enable it to be separated with facility from the tree. The workmen remark, also, that the state of the atmosphere produces an evident influence on the process.

One day the wind was blowing from the north and the sky was unclouded—the bark was removed with more than usual difficulty. In the afternoon clouds rose in the west, thunder rolled, and at the same instant the bark, to the great astonishment of the workmen, fell spontaneously from the trees. They soon had reason to ascribe this to the state of the atmosphere, since the effects ceased when the storm passed away.

There are a multitude of popular impressions respecting the effects of thunder, which have been generally regarded as destitute of foundation, and not even worthy of serious attention. Such are the received opinions that thunder curdles milk, renders wine, beer, and other fermented liquors, sour, and taints fresh meat. After the facts, however, which have been stated above, it would be rash to pronounce assertions so unanimous of cooks, brewers, winemakers, butchers, &c., to be false. Instead of being regarded as subjects of ridicule and contempt, such questions should be submitted to serious experimental inquiry.

Among the numerous manifestations of the discharge of electric matter from the surface of the earth produced by the influence of the electricity of the air, one of the most circumstantial and authentic is due to *Brydow*, who, being on the spot where the occurrences took place, was in part witness to them, and collected the particulars from other eye-witnesses with scrupulous care.

On the 10th July, 1785, a storm broke out between noon and one o'clock, in the neighborhood of *Cold-stream*. During its continuance, there occurred in the surrounding country several remarkable accidents.

A woman who was cutting grass on the banks of the *Tweed*, was suddenly thrown down without any apparent cause. She called her companions immediately to her aid, and told them that she received a sudden and violent blow on the soles of her feet, but whence it proceeded she could not tell. At the moment this happened there was neither thunder nor lightning.

A shepherd attached to a farm called *Lennel Hill*, saw a sheep suddenly fall which the moment before appeared in perfect health. He ran to raise it from the ground and found it stiff dead. The storm was then approaching, but distant.

Two coal-wagons, driven by two boys, seated on the benches in front of them, had just crossed the *Tweed*, and were in the act of ascending a hill on the banks of the river, when a loud explosion was heard like the report of several guns fired nearly together, and unattended by any rolling or continued sound-like that which usually accompanies thunder. At the moment of this explosion, the boy who drove the second wagon saw the foremost wagon with the two horses and driver suddenly fall to the ground, the coal being scattered about in all directions. On examination, the driver and horses were found to be stiff dead. The coal which was dispersed had the appearance of having been for some time in the fire. At the points where the tires of the wheels rested at the time of the explosion, the ground was found to be pierced by two circular holes, which being examined by *Brydow*, half an hour after the occurrence, emitted a strong odor resembling that of ether. The tires of the wheels showed evident marks of fusion at the points which were in contact with the

road at the moment of the explosion, and at no other part. The hair was singed on the legs and under the bellies of the horses, and by a careful examination of the marks left in the dust of the road where they fell, it was apparent that they must have been struck suddenly stone dead, so that no life remained when they touched the ground. Had there been any convulsive struggle, the marks would have been visible. The body of the driver was scorched in different places, and his dress, shirt, and particularly his hat, were reduced to rags. A strong odor proceeded from them.

All the witnesses of this occurrence agreed, that no luminous appearance whatever attended it. The driver of the second wagon was conversing with his comrade, and was looking toward him at the moment he was struck down, being at about twenty yards behind him, but saw no light. A shepherd standing in an adjacent field, told Mr. Brydone that he had his eye on the wagon at the very instant of the explosion, but he saw no light. He saw a vortex of dust arise at the place of the explosion, but unaccompanied by any luminous appearance. Finally, Mr. Brydone himself at the moment of the event was standing at an open window, with a watch in his hand, explaining to the persons around him the method of calculating the distance of the lightning, by observing the interval between the flash and the thunder, and he heard the explosion, but perceived no light.

The explanation of these effects which naturally presents itself to a mind conversant with the laws established by experiment on artificial electricity is that the natural electricities of some subterraneous conductors are decomposed by the inductive action of the atmosphere, or by other causes, and that the fluid thus liberated and accumulated immediately under the non-conducting crust which forms the surface breaks through that crust, and passes to the nearest external conductor. Hence the fusion of the tires of the wheels by electricity issuing from holes immediately under them.

The absence of light in the electric emanations which proceed from the ground is not general. The following statements coming from an authority not to be questioned will illustrate this :—

On the 10th of September, 1713, Maffei relates, that having been delayed for some time near the chateau of Fosdinova, in the territory of Massanara, he took shelter from a storm in the chateau, where, with the Marquis de Mulaspina, he was received by the mistress of the house in a room situate on the ground floor. There they saw suddenly appear on the surface of the ground a vivid flame, having a light partly white and partly azure. This flame was much agitated, but had no progressive motion. After gradually acquiring a considerable volume, it suddenly disappeared. At the instant of its disappearance Maffei felt in his shoulder, proceeding from his back upward, a peculiar tickling sensation (un chatouillement particulier); plaster detached from the ceiling of the room fell upon his head, and in fine, he heard an explosion different, however, from the sound of thunder.

In a letter addressed to Apostolo Zeno, Maffei states that, on the 26th of July, 1731, lightning struck at Casalaone, accompanied by thunder as loud as a cannonade, the principal tower, tore away the escutcheon bearing the arms of the town, destroying the stone mouldings, and did other damage. This occurrence was preceded by the appearance of a great flame at a little distance from the ground.

The following statement is on the authority of the abbé Richaud :—

“On the 2d July, 1750, at 3 o'clock in the afternoon, being in the church of *St. Michel, at Dijon*, during a storm I saw appear suddenly between the first two pillars of the principal nave a red flame, which was suspended in the air at the height of three feet from the floor. This flame then gradually augment-

ed its volume until it attained the height of from twelve to fifteen feet. After having risen through several fathoms in a diagonal direction nearly to the height of the organ gallery, it disappeared with an explosion like the report of a cannon discharged in the church."

The fire evolved from the earth by the influence of atmospheric causes, is not extinguished by passing through water.

On the night between the 4th and 5th of September, 1767, during a violent storm, the keeper of a fish-pond near *Parthenai*, in *Poitou*, saw the entire pond covered with a flame so dense as to prevent him from seeing the surface of the water. The next day dead fish floated on the pond.

The existence of a storm in the air is not a necessary condition in the causes which govern the evolution of these terrestrial fires.

On the 4th of November, 1749, in latitude N. $42^{\circ} 48'$, longitude W. 2° , a few minutes before noon, the sky being unclouded, a globe of bluish fire, having the appearance of a mill-stone, rolled rapidly along the surface of the sea toward the British ship *Montague*. At a little distance from the vessel it rose vertically from the water and struck the masts with an explosion like that of several hundred pieces of artillery, committing much damage to the masts and rigging. Five sailors were laid senseless on the deck, one of whom was severely burned. The usual effect of lightning were observed. A sulphureous odor was diffused through the ship, and large iron nails, torn from various parts of the vessel, were projected on the deck with such force that strong pincers were necessary to draw them out.

Sometimes luminous emanations assume the appearance of a cloud of light, maintaining a stationary position.

Major Sabine and Captain James Ross, in their first northern expedition, being in the Greenland seas, during one of the dark nights of these regions, were called up by the officer of the deck to observe an extraordinary appearance. Ahead of the vessel, and lying precisely in her course, appeared a stationary light, resting on the water and rising to a considerable elevation—every other part of the heavens and the horizon, all around the ship, being as black as pitch. As there was no known danger in this phenomenon, the course of the vessel was not changed. When the ship entered the region of this light, the officers and crew looking on with the liveliest interest, the whole vessel was illuminated, the most elevated parts of the masts and sails, and the minutest parts of the rigging, became visible. The extent of this luminous atmosphere might have been about 450 yards. When the bow of the ship emerged from it, it seemed as if the vessel were suddenly plunged in darkness. There was no gradual decrease of illumination. The ship was already at a considerable distance from the luminous region, when it was again visible, as a stationary light astern.

This narrative was addressed to M. Arago in a letter from Dr. Robinson, of *Armagh*, who received it from MM. Sabine and Ross. "The cause of these phenomena," says M. Arago, "to use the beautiful expression of Pliny, is still hidden in the majesty of nature."

Besides these unusual luminous phenomena, many philosophers, among whom are Maffei and Chappe, have maintained that storms are almost always attended by common lightning, which issues from the earth and strikes the clouds. Nor are such statements made in a general and vague form, but the partisans of this doctrine declare that they have, themselves, *distinctly seen* such lightning rise like a rocket. If such statements be correct, it must be assumed that the speed of this ascending lightning is infinitely less than that of the cuspidated lightning, since the progressive motion of the latter cannot be observed. The ascending lightning, if the accounts of it be correct, must be analogous in its motion to ball-lightning.

Of the flames which issue from the earth and form objects upon it, the most common and most frequently observed are those which have appeared on the points of spears, and more frequently still on the extremities of the masts and yards of ships. These were observed by and known to the ancients long before electricity assumed its place among the sciences. When they appear in two flames on the masts and rigging of vessels seamen call them *Castor* and *Pol-lux*, when as a single flame, *Helen*. The latter is regarded as an evil omen, the former a presage of a favorable voyage. Passing over many examples of these phenomena of remote date, and which might be considered of doubtful accuracy, we shall here state a few of the more recent instances of them.

On the 25th of January, 1822, during a heavy shower of snow, M. de Thielaw, on his route to Freyburg, observed the branches of the trees in a heavy shower of snow, to emit a bluish light.

On the 14th of January, 1824, immediately after a storm, a large black cloud overspreading the sky, M. Maxadorf saw a wagon on which a load of straw was transported into the middle of a field, near Cathen, and observed that the blades of straw stood on end, and seemed to be on fire, a vivid flame also issued from the whip of the driver. This appearance lasted about ten minutes and ceased when the wind had dispersed the cloud.

On the 8th of May, 1831, some officers of the French engineers and artillery were walking after sunset, with their heads uncovered, on the terrace of Bab-Azoun, at Algiers. Each looking at the others observed with unqualified astonishment, that the hairs of his companions stood on end, and little jets of flame issued from them. When the officers raised their hands, similar jets issued from their fingers.

Similar phenomena are seen to issue from the pointed extremities of steeples and other elevated structures.

IX. LUMINOUS RAIN.

The following are the proofs and examples of the occurrence of this class of phenomena collected by M. Arago :—

On the 3d June, 1731, Hallai, prior of the Benedictines of Lessay, near Constance, states that he saw in the evening, during a thunder-storm, rain fall like drops of red-hot liquid metal.

In 1761, Bergman wrote to the Royal Society of London that he observed on two occasions, toward evening, and when no thunder was heard, rain which sparkled as it struck the ground, which seemed to be covered with waves of fire.

On the morning of the 22d of September, 1773, in the district of Skara, in East Gothia, in Sweden, a thunder-storm broke, attended by very violent rain. The rain commenced at six o'clock in the evening. All the accounts agree in stating that the drops struck fire and scintillated on touching the ground.

On the 3d of May, 1768, near La Canche, about two leagues from Arny-le-Duc, M. Pasumot was caught on an open plain by a violent storm. The rain-water collected abundantly on the leaf of his hat, and when he stooped his head to let it flow off, he observed that in its fall, encountering that which fell from the clouds at about twenty inches from the ground, sparks were emitted between the two portions of liquid.

On the 28th of October, 1772, on his way from Brignai to Lyons, the abbé Bertholon was caught in a storm at five o'clock in the morning. Rain and hail fell heavily. The drops of rain and the hail-stones which struck the metallic parts of the mounting of his horse's trappings, emitted jets of light.

A friend of Howard, the meteorologist, on his way from London to Bow, on

the 19th of May, 1809, during a violent storm, saw distinctly the drops of rain emit light when they struck the ground.

On the 25th of January, 1822, the miners of Freyburg informed Lampadius that the sleet which fell during a storm, emitted light when it struck the ground.

This emission of light is not peculiar to water, whether in a liquid or frozen state.

During the eruption of Vesuvius, which took place in 1794, a shower of dust as fine as snuff fell in Naples and its environs. This dust emitted light, which, though pale, was distinctly visible at night. Mr. James, an English gentleman, who happened at the time to be in a boat near Terra-del Greco, observed that his hat and those of the boatmen and the parts of the sails where the dust lodged, shed around a sensible light.

These several phenomena seem capable of easy explanation, by admitting the rain, hail, or snow, coming from the clouds, and the surface of the earth and objects upon it, to be in opposite electrical states.

POPULAR FALLACIES.

Fallacious Indications of Senses.—Errors of the Sense of Feeling.—Erroneous Impressions of Heat and Cold.—Explanation of these by the Principle of Conduction.—Why a Fan is cooling.—Feats of the Fire-King explained.—Horizontal Appearance of the Sun and Moon.—Deceptive Oval Disk in the Horizon.—Deceptions of Vision—of Taste—of Smelling.

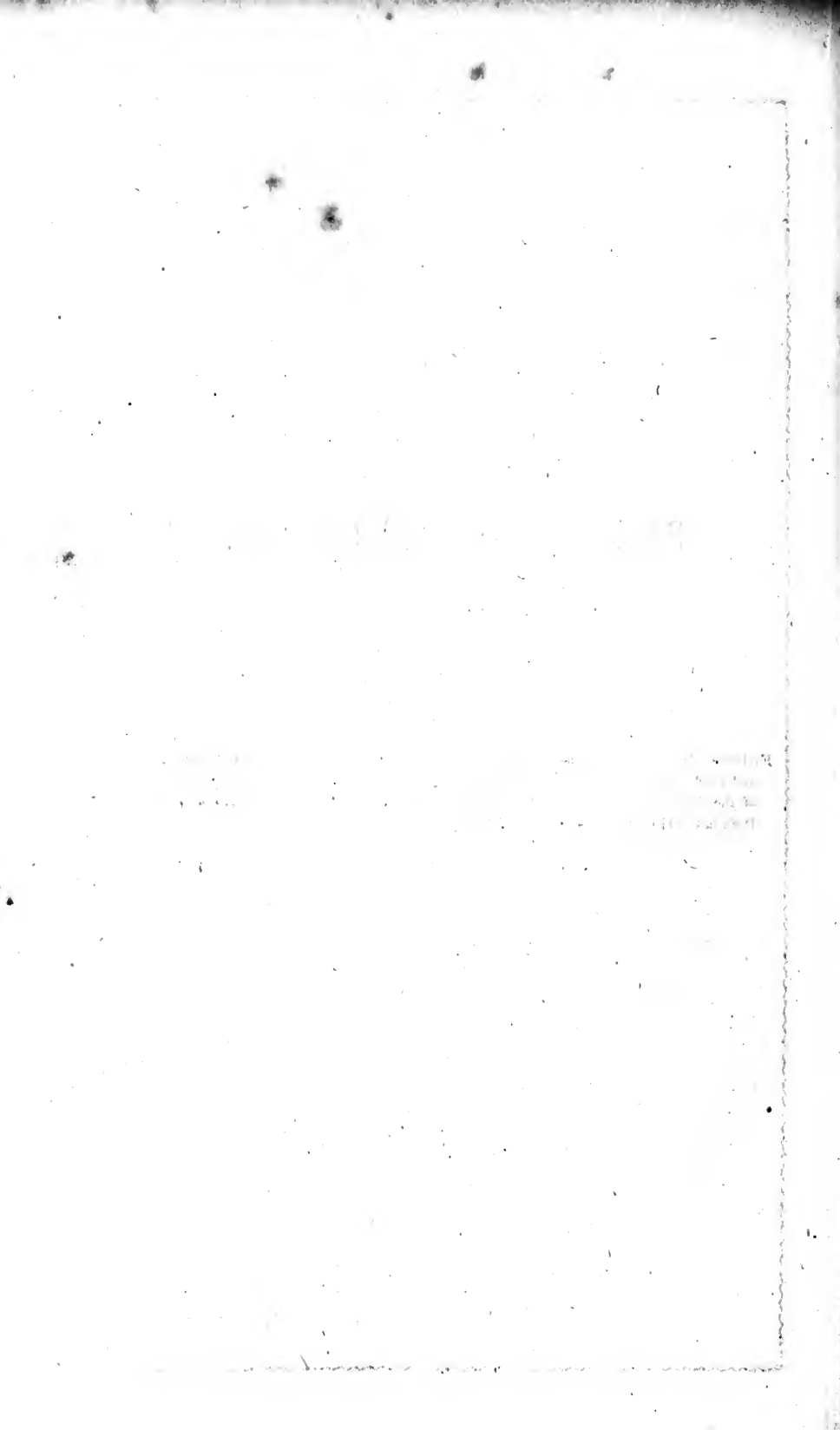

POPULAR FALLACIES.

Of all the means of estimating physical effects, the most obvious, and those upon which mankind place the strongest confidence, are the senses. The eye, the ear, and the touch, are appealed to by the whole world as the unerring witnesses of the presence or absence, the qualities and degrees, of light and color, sound and heat. But these witnesses, when submitted to the scrutiny of reason, and cross-examined, so to speak, become involved in inexplicable perplexity and contradiction, and speedily stand self-convicted of palpable falsehood. Not only are our organs of sensation not the best witnesses to which we can appeal for exact information of the qualities of the objects which surround us, but they are the most fallible guides which can be selected. Not only do they fail in declaring the qualities or degrees of the physical principles to which they are by nature severally adapted, but they often actually inform us of the presence of a quality which is absent, and of the absence of a quality which is present.

The organs of sense were never, in fact, designed by nature as instruments of scientific inquiry; and had they been so constituted, they would probably have been unfit for the ordinary purposes of life. It is well observed by Locke, that an eye adapted to discover the intimate constitution of the atoms which form the hand of a clock, might be, from the very nature of its mechanism, incapable of informing its owner of the hour indicated by the same hand. It may be added, that a pair of telescopic eyes, which would discover the molecules and population of a distant planet, would ill requite the spectator for the loss of that ruder power of vision necessary to guide his steps through the city he inhabits, and to recognise the friends which surround him. The comparison of instruments adapted for the use of commerce and domestic economy, and those designed for domestic purposes, furnishes a not less appropriate illustration of the same fact. The highly delicate balance used by the philosopher in his inquiries respecting the relative weights and proportions of the constituent elements of bodies, would, by reason of its very perfection and sensi-

bility, be utterly useless in the hands of the merchant or the housewife. Each class of instruments has, however, its peculiar uses; and is adapted to give indications with that degree of accuracy which is necessary and sufficient for the purpose to which it is applied.

The term heat in its ordinary acceptation, is used to express a feeling or sensation which is produced in us when we touch a hot body. We say that the heat of a body is more or less intense, according to the degree in which the feeling or sensation is produced in us. The term is often, however, used in a somewhat different sense. It is here applied to express a certain state of body, which is attended with certain distinct mechanical effects, many of which are capable of being actually measured, and one of which only is the effect produced on our organs, and through them, on the mind, to which alone, in the popular sense, the term heat is applied. This distinction in the use of the term has induced some philosophers to adopt another word, caloric, to express the physical effect, while the common term, heat, has been retained to express the sensation. It does not appear to us to be necessary to adopt this term, because it never happens that any confusion arises from the two senses of the term heat; and, besides, the use of the term caloric is apt to lead the mind to the assumption of an hypothesis, or theory, concerning the nature of heat, the consequences of which are apt to be mixed with that investigation which should be founded on the results of experiment alone.

The touch, by which we acquire the perception of heat, like the eye, ear, and other organs, is endowed with a sensibility confined within certain limits; and even within these we do not possess any exact power of perceiving or measuring the degree of the quality by which the sense is affected. If we take two heavy bodies in the hand, we shall in many cases be able to declare that one is heavier than the other; but if we are asked whether one be exactly twice as heavy, or thrice as heavy as the other, we shall be utterly unable to decide. In like manner, if the weights be nearly equal, we shall be unable to declare whether they are exactly equal or not. If we look at two objects, differently illuminated, we shall in the same way be in some cases able to declare which is the more splendid; but if their splendor be nearly equal, the eye will be incapable of determining whether the equality of illumination be exact or not. It is the same with heat. If two bodies be very different in temperature, the touch will sometimes inform us which is the hotter; but if they be nearly equal, we shall be unable to decide which has the greater or which the less temperature.

But even this information, rude and unsatisfactory as it is, is more full than that which the evidence of the touch frequently furnishes.

After what has been explained in the preceding part of this treatise, the reader will have no difficulty in perceiving that feeling can never inform us of the quantity of heat which a body contains, much less of the relative quantities contained in two bodies. In the first place, the touch can never be affected by heat which exists in the latent state. Ice-cold water, and ice itself, *feel* to have the same temperature, and to contain the same quantity of heat; and yet it is proved that ice-cold water contains a great deal more heat than ice; nay, that it can be compelled to part with its redundant heat, and to become ice; and that this redundant heat, when so dismissed, may be made to boil a considerable quantity of water. But it is not only in the case of latent heat, which cannot be felt at all, that the touch fails to inform us of the quantities of heat in a body. It has been shown that different bodies are raised to the same temperature by very different quantities of heat. If water and mercury, both at the temperature of 32° , be touched, they will be felt to be both equally cold; and if they be both raised to 100° and then touched, they will be felt to be both

equally warm; and the inference would be, that equal quantities of heat must have been in the meanwhile communicated to them. Now, on the contrary, it has been proved that, in this case, the quantity of heat which has been communicated to the water is not less than thirty times the quantity which has been imparted to the mercury. In fact, to cause the same change of temperature, and, therefore, the same feeling of heat, in different bodies, requires very different quantities of heat to be imparted to them. It is plain, therefore, that the sense of touch totally fails in the discovery of the quantities of heat which must be added to different bodies, in order to produce in them the same change of temperature.

But it may be said that the thermometer itself is here in the same predicament as the touch, and that this scientific measure of heat likewise fails to indicate the quantity of that principle which has been added or subtracted. Setting aside, however, the estimation of quantities of heat, the sense of touch is not less fallacious in the indications which it gives of temperature itself; and here, indeed, the error and confusion into which it is apt to lead, when unaided by the results of science, are very conspicuous. If we hold the hand in water which has a temperature of about 90° , after the agitation of the liquid has ceased we shall become wholly insensible of its presence, and will be unconscious that the hand is in contact with any body whatever. We shall, of course, be altogether unconscious of the temperature of the water. Having held both hands in this water, let us now remove the one to water at a temperature of 200° , and the other to water at the temperature of 32° . After holding the hands for sometime in this manner, let them be both removed, and again immersed in the water at 90° ; immediately we shall become sensible of warmth in the one hand, and cold in the other. To the hand which had been immersed in the cold water, the water at 90° will feel hot, and to the hand which had been immersed in the water at 200° , the water at 90° will feel cold. If, therefore, the touch be in this case taken as the evidence of temperature, the same water will be judged to be hot and cold at the same time.

If, in the heat of summer, we descend into a cave, we become sensible that we are surrounded by a cold atmosphere; but if, in the rigor of a frosty winter, we descend into the same cave, we are conscious of the presence of a warm atmosphere. Now a thermometer suspended in the cave on each of these occasions, will show exactly the same temperature, and, in fact, the air of the cave maintains the same temperature at all seasons of the year. The body, however, being in the one case removed from a warm atmosphere into a colder one, and in the other case, from a very cold atmosphere into one of a higher temperature, becomes in the latter case sensible of warmth, and in the former, of cold.

Thus we see that the sensation of heat depends as much on the state of our own bodies, as that of the external bodies which excite the sensation; the same body at the same temperature producing different sensations of heat and cold, according to the previous state of our bodies when exposed to it.

But even when the state of our bodies is the same, and the temperature of external objects the same, different objects will feel to us to have different degrees of heat. If we immerse the naked body in a bath of water at the temperature of 120° , and, after remaining for some time immersed, pass into a room in which the air and every object is raised to the same temperature, we shall experience, in passing from the water into the air, a sensation of coldness. If we touch different objects in the room, all of which are at the temperature of 120° , we shall nevertheless acquire very different perceptions of heat. When the naked foot rests on a mat or carpet, a sense of gentle warmth is felt; but if it be removed to the tiles of the floor, heat is felt sufficient to produce inconvenience. If the hand be laid on a marble chimney-piece, a strong heat is

likewise felt, and a still greater heat on any metallic object in the room. Walls and woodwork will be felt warmer than the matting, or the clothes which are put on the person. Now, all these objects are, nevertheless, at the same temperature. From this chamber let us suppose that we pass into one at a low temperature; the relative heats of all the objects will now be found to be reversed—the matting, carpeting, and woollen objects, will feel the most warm; the woodwork and furniture will feel colder; the marble colder still; and metallic objects the coldest of all. Nevertheless here, again, all the objects are exactly at the same temperature, as may be in like manner ascertained by the thermometer.

In the ordinary state of an apartment, at any season of the year, the objects which are in it all have the same temperature, and yet to the touch they will feel warm or cold in different degrees: the metallic objects will be coldest; stone and marble less so; wood still less so; and carpeting and woollen objects will feel warm.

When we bathe in the sea, or in a cold bath, we are accustomed to consider the water as colder than the air, and the air colder than the clothes which surround us. Now all these objects are, in fact, at the same temperature. A thermometer, surrounded by the cloth of our coat, or suspended in the atmosphere, or immersed in the sea, will stand at the same temperature.

A linen shirt when first put on will feel colder than a cotton one, and a flannel shirt will actually feel warm; yet all these have the same temperature.

The sheets of the bed feel cold and blankets warm; the blankets and sheets, however, are equally warm. A still, calm atmosphere, in summer, feels warm; but if a wind arises the same atmosphere feels cold. Now a thermometer, suspended under shelter, and in a calm place, will indicate exactly the same temperature as a thermometer on which the wind blows.

These circumstances may be satisfactorily explained, when it is considered that the human body maintains itself almost invariably, in all situations, and at all parts of the globe, at the temperature of 96° ; that a sensation of cold is produced when heat is withdrawn from any part of the body faster than it is generated in the animal system; and, on the other hand, warmth is felt when either the natural escape of the heat generated is intercepted, or when some object is placed in contact with the body which has a higher temperature than that of the body, and consequently imparts heat to it. The transition of heat from the body to any object when that object has a lower temperature, or from the object to the body when it has a higher temperature, depends, in a certain degree, on the conducting power of the objects severally, and the transition will be slow or rapid, according to that conducting power. An object, therefore, which is a good conductor of heat, if it has a lower temperature than the body, carries off heat quickly, and feels cold; if it has a higher temperature than the body, it communicates heat quickly, and feels hot.

A bad conductor, on the other hand, carries off and communicates heat very slowly, and therefore, though at a lower temperature than the body, is not felt to be colder, and, though at a higher temperature, not felt to be warm.

Most of the apparent contradictions which have been already adduced in the results of sensation, compared with thermometric indications, may be easily understood by these principles.

When we pass from a hot bath into a room of the same temperature, the air, though at a higher temperature than our body, communicates heat to it more slowly than the water, because, being a more rare and attenuated substance, a less number of its particles are in actual contact with the body; and also such particles as are in contact with the body take almost the same temperature as the body, and adhere to it, forming a sort of coating or shield, by which the

body is defended from the effects of the hotter part of the surrounding atmosphere. A carpet, being a bad conductor of heat, fails to transmit heat to the foot, and therefore, though at a higher temperature than the body, creates no sensation of warmth. The tiles and marble, being better conductors of heat, and at a higher temperature than the body, transmit heat readily, and metallic objects still more so: these, therefore, feel hot. On passing into a cold room, the very contrary effects ensue. Here all the objects have a temperature below that of the body; the carpet and other bad conductors, not being capable of receiving heat when touched, produce no sensation of cold; wood, being a better conductor, feels cooler; marble, being a better conductor, gives a still stronger sensation of cold; and metal, the best of all conductors, produces that sensation in a still greater degree.

In cold temperatures, the particles of water which carry off the heat from the body are far more numerous than those of air, and therefore carry the heat off more rapidly; and, besides, they are constantly changing their position; the particles warmed by the body immediately ascend by their levity, and cold particles come into contact with the skin. Thus water, although a bad conductor of heat, has the same effect as a good conductor, by the effect of its currents.

Sheets feel colder than the blankets, because they are better conductors of heat, and carry off the heat more rapidly from the body; but when, by the continuance of the body between them, they acquire the same temperature, they will then feel even warmer than the blanket itself. Hence it may be understood why flannel, worn next the skin, forms a warm clothing in cold climates, and a cool covering in hot climates.

To explain the apparent contradiction implied in the fact that the use of a fan produces a sensation of coldness, even though the air which it agitates is not in any degree altered in temperature, it is necessary to consider that the air which surrounds us is generally at a lower temperature than that of the body. If the air be calm and still, the particles which are in immediate contact with the skin acquire the temperature of the skin itself, and, having a sort of molecular attraction, they adhere to the skin in the same manner as particles of air are found to adhere to the surface of glass in philosophical experiments. Thus sticking to the skin, they form a sort of warm covering for it, and speedily acquire its temperature. The fan, however, by the agitation which it produces, continually expels the particles thus in contact with the skin, and brings new particles into that situation. Each particle of air, as it strikes the skin, takes heat from it by contact, and, being driven off, carries that heat with it, thus producing a constant sensation of refreshing coolness.

Now from this reasoning it would follow that, if we were placed in a room in which the atmosphere has a higher temperature than 96° , the use of a fan would have exactly opposite effects, and, instead of cooling, would aggravate the effects of heat; and such would, in fact, take place. A succession of hot particles would, therefore, be driven against the skin, while the particles which would be cooled by the skin itself would be constantly removed.

It may be objected to some of the preceding reasonings, that glass and porcelain, though among the worst conductors of heat, generally feel cold. This, however, is easily explained. When the surface of glass is first touched, in consequence of its density and extreme smoothness, a great number of particles come into contact with the skin; each of these particles, having a tendency to an equilibrium of temperature, takes heat from the skin, until they acquire the same temperature as the body which is in contact with them. When the surface of the glass, or perhaps the particles to some very small depth within it, have acquired the temperature of the skin, then the glass will cease to feel cold, because its bad-conducting power does not enable it to attract more heat

from the body. In fact, the glass will only feel cold to the touch for a short space of time after it is first touched. The same observation will apply to porcelain and other bodies which are bad conductors, and yet which are dense and smooth. On the other hand, a mass of metal, when touched, will continue to be felt cold for any length of time, and the hand will be incapable of warming it, as was the case with the glass.

A silver or metallic teapot is never constructed with a handle of the same metal, while a porcelain teapot always has a porcelain handle. The reason of this is, that metal being a good conductor of heat, the handle of the silver or other metallic teapot would speedily acquire the same temperature as the water which the vessel contains, and it would be impossible to apply the hand to it without pain. On the other hand, it is usual to place a wooden or ivory handle on a metal teapot. These substances being bad conductors of heat, the handle will be slow to take the temperature of the metal, and even if it does take it, will not produce the same sensation of heat in the hand. A handle, apparently silver, is sometimes put on a silver teapot, but, if examined, it will be found that the covering only is silver; and that at the points where the handle joins the vessel, there is a small interruption between the metallic covering and the metal of the teapot itself, which space is sufficient to interrupt the communication of heat to the silver which covers the handle. In a porcelain teapot, the heat is slowly transmitted from the vessel to its handle; and even when it is transmitted, the handle, being a bad conductor, may be touched without inconvenience.

A kettle which has a metal handle cannot be touched, when filled with boiling water, without a covering of some non-conducting substance, such as cloth, or paper, while one with a wooden handle may be touched without inconvenience.

The feats sometimes performed by quacks and mountebanks, in exposing their bodies to fierce temperatures, may be easily explained on the principle here laid down. When a man goes into an oven, raised to a very high temperature, he takes care to have under his feet a thick mat of straw, wool, or other non-conducting substance, upon which he may stand with impunity at the proposed temperature. His body is surrounded with air, raised, it is true, to a high temperature, but the extreme tenuity of this fluid causes all that portion of it in contact with the body, at any given time, to produce but a slight effect in communicating heat. The exhibitor always takes care to be out of contact with any good conducting substance; and when he exhibits the effect produced by the oven in which he is enclosed, upon other objects, he takes equal care to place *them* in a condition very different from that in which he, himself, is placed; he exposes them to the effect of metal or other good conductors. Meat has been exhibited, dressed in the apartment with the exhibitor; a metal surface is, in such a case provided, and probably heated to a much higher temperature than the atmosphere which surrounds the exhibitor.

But although the sense of touch be, perhaps, the most exposed to have its impressions misinterpreted, it is not the only sense which affords examples of striking popular fallacies. Abundance of these are offered in the case of the sense of sight.

Every one is familiar with the appearance of the sun and moon when rising and setting. The apparently large orb which they present to the senses is an object of familiar notice. Is not every one impressed with a conviction that the apparent magnitude of the sun when it rises, glowing with a redness acquired from the depth of air through which its rays then pass, is much greater than the apparent magnitude of the same object at noonday? and is not the same impression admitted with respect to the rising or setting full moon, com-

pared with the same object seen on the meridian? Yet nothing is more easy than to prove, as a matter of fact, that these impressions are fallacious. Let any one adopt any convenient method which may occur to him, to measure the apparent magnitude of the sun in the horizon, and again in the meridian, and he will find them the same. This may be accomplished by extending two threads of fine silk parallel to each other in a frame, and placing them in such a position, and at such a distance from the eye, that when presented to the sun or moon, in the horizon, they will, exactly, touch its upper and lower limb, so that their apparent distance asunder will be equal to the apparent diameter of the lunar or solar disk.

If this arrangement be preserved, and the sun or moon be viewed in the same manner when at, or near, the meridian, it will be found that the threads will equally touch its upper and lower limbs, and that their interval will still measure its apparent diameter.

In fact, all astronomical telescopes are provided with an apparatus by which observations of this kind can be made with the greatest accuracy and facility. There is a system of parallel fibres or wires extended across the field of view, which are removed toward or from each other by an adjusting screw. The magnitudes of the disks of the sun, moon, or planets, can be ascertained by moving two of these wires until one of them shall touch the upper, and the other the lower limb of the disk. By means of such an instrument, the magnitude of the sun or moon in the horizon, and in the meridian, may be measured, and it is found not to be sensibly different.

It will, therefore, be evident that whatever be the cause of the illusion, the apparent magnitude of the sun or moon is not greater at rising or setting than in the meridian. Whence, then, it may be asked, arises an impression so universally entertained? In fact, the moon is 4,000 miles further from us when it sets or rises, than when it south's, or passes the meridian, and, strictly speaking, therefore, its apparent diameter, instead of appearing larger, ought to appear about a sixtieth part less.

This illusion has been attempted to be explained by supposing that, as the moon is less brilliant in the horizon than in the zenith, we open the pupil of the eye wider on looking at it when in the horizon, and it is for this reason we see it larger. But this reasoning is, obviously, invalid, inasmuch as we know from the principles of optics, that the image produced in the eye has the same magnitude to whatever extent the pupil may be dilated or contracted.

The explanation of this singular effect, in which all astronomers appear to concur, refers it to mental, and not optical causes; strictly speaking, it is not an optical illusion. The organ of vision does not, itself, present to us a larger moon in the horizon than in the zenith, as is proved incontestably by the mitrometric wires. The error is, then, one of the mind and not one of the senses. The estimate which we form of the actual magnitude of any visible object, depends on a comparison of the apparent magnitude which that object presents to the eye, with the distance at which we imagine it to be. Thus if there be two objects, buildings, for example, which have to the eye the same apparent height, but which we know or believe to be at different distances from us, we instinctively, and without any operation of the judgment, of which we are conscious, conceive that which is more distant to be the largest; and in like manner, if two objects, which are at different distances, appear to the eye to be of different heights, the more remote being less than the nearer, we judge them, nevertheless, to be equal in size, ascribing, by an unconscious action of the mind, the difference of their apparent magnitudes to their difference of distance.

To apply this reasoning to the case of the sun or moon, we are to consider

that when either of these objects are in the horizon, a portion, at least, of the space between the eye and them is occupied by a series of objects with the magnitudes and relative positions of which we are familiar. We are, therefore, enabled to make some estimate of a portion of the space that intervenes between the eye and the object. But when the object is in a more elevated position in the firmament, no part of the intervening distance is thus spaced out, and we are accustomed to consider the object nearer to the eye. It is for this reason that the first impression produced upon the mind by a view of the firmament is that of a flat, spherical vault, resting upon the circle of the horizon, the higher parts being much nearer to us than its horizontal boundaries. This universal impression will be readily acknowledged by every observer. Yet that it is a mental and not an optical deception, is proved by showing that the visual magnitudes when measured are the same for every object at all altitudes.

Conceding this, then, it will be asked how it explains the universal impression of the enormously large disk of the sun or moon when rising or setting, the answer is, that when in or near the horizon the mind is impressed with the idea that the distance of these objects is much greater than when in the meridian, and that their apparent magnitude being the same, the real magnitude is judged to be greater in the same proportion as the distance is supposed to be greater. Thus, if we are impressed with the notion that the sun seen in the horizon is twice as distant as the sun seen in the meridian, we shall infer its diameter to be twice as great, since it appears the same; and if its diameter is twice as great, its apparent superficial magnitude will be four times as great.

The operations of the judgment in such cases are so rapid, and the effect of habit is such, that we are altogether unconscious of them. A thousand examples might be given of bodily actions and motions performed by the dictates of the will, of which we retain no consciousness. It is difficult in the case we have just explained, for minds unaccustomed to metaphysical inquiries, to satisfy themselves of the validity of the explanations we have given. Yet, if it be remembered that it is capable of unequivocal proof that the illusion is not optical, and that, in fact, the apparent magnitude of the moon in the horizon and the meridian are not different, it will easily follow that the error must be mental, and the only explanation which has ever been given of it is that which we have here offered.

While referring to the subject of the appearance of the sun and moon at rising and setting, I may take the opportunity of noticing the oval form which they present, the vertical diameter being shorter than the horizontal diameter. This is not, as in the former case, an optical illusion; it is an effect produced by the power of the atmosphere to deflect the rays of light which are transmitted through it. By this principle of refraction, all objects appear at a greater altitude than that which they really have; and this error of position increases as they approach the horizon. In accordance with this principle, the upper limb of the sun is less elevated than the lower limb, and, consequently, the two limbs are brought nearer together than they would be if equally affected by refraction. On the other hand, the extremities of the horizontal diameters being equally affected, its length is not altered. Since, therefore, the vertical diameter is shortened, and the horizontal diameter unaltered, the figure becomes an oval. Strictly speaking, this is the case with the sun and moon in all parts of the heavens except in the zenith; but the effect is so slight that, except at low altitudes, it is not perceptible.

The cause of the red color which the sun and moon have when near the horizon is, that the atmosphere through which the light passes, being generally

charged more or less with cloudy matter; the bluish tints are absorbed, and the predominance of the red light transmitted.

There is perhaps no sense which more requires the vigilant exercise of the understanding to rectify its impressions, than that of sight. The susceptibility of the organ of vision itself is liable to frequent and rapid change, and the same objects at different times produce upon it extremely different impressions. A situation in which, in one condition of the eye, we shall appear to be in absolute darkness, will present to us, in another state of the organ, sufficient light to render visible the objects around us. If we are suddenly deprived of the illumination of any strong artificial light, we appear to be for the moment in absolute darkness; but when the organ of vision has had time to recover itself, we often find that there is sufficient light to guide us.

"Thus when the lamp that lighted
The traveller at first goes out,
He feels awhile benighted,
And lingers on in fear and doubt.

"But soon, the prospect clearing,
In cloudless starlight on he treads,
And finds no lamp so cheering
As that light which heaven sheds."

THOMAS MOORE.

The mechanism which the all-wise Artisan that made the eye has contrived to meet these contingencies is marked by the same perfection that prevails through all his works. The opening in the front of the eye, called the pupil, through which light is admitted to produce vision, is surrounded by an elastic ring, called the iris, which is capable of being contracted or enlarged by the action of certain muscles with which it is connected. It is the magnitude of this opening that determines the quantity of light transmitted to the retina. If, then, we are in a room illuminated with a strong lamp, the muscles which govern the opening of the pupil contract its dimensions until so much light only is admitted as is consistent with the healthful condition of the eye. If the lamp be suddenly extinguished, and the room be left dependant only on the light admitted by the windows, from the nocturnal firmament, we shall at first appear to be in profound darkness, but immediately the pupil will begin to expand, and will presently become so enlarged that enough of light will be received into the eye to render the objects around us faintly visible.

If in this condition of the organ the lamp again be suddenly brought into the room, the eye will be pained by its light, and the eyelid will immediately drop to give it relief; for the enlargement of the pupil which has taken place to accommodate it to the faint light to which it was previously exposed, will admit so great a quantity of the strong light of the lamp as to hurt the retina, and the contraction of the pupil cannot be effected with sufficient rapidity to protect the organ from this injury. But the beneficent Maker of the eye has provided for this purpose the eyelid, which is capable of closing instantaneously, and which gives the pupil time to contract, and to accommodate its dimensions to the new condition to which it is exposed.

The perception we receive of the color of an object depends often as much on the condition of the eye when the object is seen as upon the object itself. By the action of lights of different colors, the sensibility of the retina may be so modified that the same object will appear at different times to have different colors, and unreal objects will often be perceived. These are called spectra. If we place on a sheet of white paper a red wafer, and, illuminating it strongly, direct the eye steadily to it for a short time, and then look at the paper close beside it, we shall there see a blue wafer of the same size. This object is an

optical spectrum. The cause of its appearance is easily explained. By the action of the strong red light proceeding from the wafer, the retina is rendered for the moment insensible to the operation of a more feeble red light upon it, for the same reason as the ear would be insensible to the ticking of a clock immediately after being affected by a discharge of artillery. Accordingly, when the eye, after viewing the red wafer, looks at a white paper beside it, the action of that portion of the compound white light reflected from the paper which is red fails to produce any perception, and the remaining constituents are not perceived, which accordingly present a bluish tint. To comprehend this, and other similar illusions, it is very necessary to remember that white light is a compound of reds, yellows, and blues, and that if we deprive it of any one of these elements it will assume the tint produced by the others. Thus, if the eye be insensible to red light, all white objects will appear to it with a tint composed of yellow and blue. If it be insensible to blue light, then white objects will appear orange.

The eye may be, and sometimes is, either from disease, or from original imperfection of structure, either imperfectly sensible or altogether insensible to lights of particular colors. To such eyes all objects will appear to have colors different from those which they present to organs of vision in the usual healthy state. We can thus easily understand the condition of a jaundiced eye. Such an organ is more or less insensible to the blue and red lights, but highly sensitive to the yellow. White objects to such an eye will appear yellow, and all other objects will appear in tints different from their proper colors, and partaking more or less the yellow hue.

Instances have more than once occurred, and are recorded in the works on optics, of individuals thus incapable, from original defects of vision, of perceiving particular colors. The late Doctor Dalton, of Manchester, was a conspicuous example of this.

But, as we have above stated, even a healthy and perfect eye will be rendered temporarily insensible to the impression of particular colors by being exposed for a short time to the strong action of colored lights. Optical illusions are produced in this way in the exhibition of fireworks. When luminous balls, some red and some white, are thrown up into the air, the white appear blue beside the red, and are generally imagined to be really blue. The effect, however, is a visual illusion, ascribable to the cause just explained.

In the sky toward sunset, when reddish clouds are arranged with openings between them, the sky at such openings appears green, although it be really blue.

In astronomical observations on the stars there is a curious case, in which it has never been settled whether the appearance is real or illusive. Many of the stars, which to the eye appear individual objects, prove to be double when examined with powerful telescopes. The two stars, thus composing a double star, are frequently of different colors, and it is found that when one is red the other is of a bluish tint. Now we know that it would appear of this tint, even though it were a white object, by reason of the presence of the red star. Whether, in these cases of double stars, the blue one would be really blue, or is rendered so by the optical effect adverted to, has not been decided, it being impossible to view it except in juxtaposition with its red companion.

If the eye be directed to the sun for a few seconds, and the eyelids then be closed, a blue spectrum of the sun will be seen, and will continue to be visible until the retina recover its state of repose.

If we write a page or two with red ink, and then commence to write with black ink, the writing will appear of a light blue color, and will continue to appear so until the retina loses the impression made by the red ink upon it. In

passing, however, from the black to the red, no illusion is produced, the black not acting on the retina so as to excite it.

If small holes be made in a red curtain, so as to admit the rays of the sun through them, the light which will be thrown upon a sheet of white paper will be the general redness produced by the semi-transparency of the curtain, with the white spots produced by the light passing through the holes; but these white spots will appear to the eyes blue.

It will appear, from these observations, that effects are produced by the juxtaposition of colors in objects of art independent of the separate properties of the colors themselves. Two colors, when seen in juxtaposition, do each of them appear to the eye different from what either would appear to be if seen separately from the other.

The senses of smelling, tasting, and even of feeling or touch, are liable to innumerable causes of deception. If the organ at the time it receives an impression be in any unusual condition, or even out of its usual position, the indication of the impression will be fallacious.

If two fingers of the same hand, being crossed, be placed upon a table, and a marble or a pea is rolled between them, the impression will be, if the eyes are closed, that two marbles or two peas are touched.

If the nose be pinched, and cinnamon be tasted, it will taste like a common stick of deal. This is not a solitary instance. Many substances lose their flavor when the nostrils are stopped. Nurses, therefore, upon right and scientific principles stop the noses of children when they give them doses of disagreeable medicine.

If things having different or opposite flavors be tasted alternately, in such rapid succession as not to allow the nerves of tasting to recover their state of repose, the power of distinguishing flavor will be lost for the moment, and the substances, however different, will be undistinguishable from one another. Thus, if the eyes be blindfolded, and buttermilk and claret be alternately tasted, the person tasting them, after a few repetitions of the process, will be unable to distinguish one from the other.

Tastes, like colors, in order to produce agreeable effects, should succeed each other in a certain order. Eating, considered as one of the fine arts in the most refined state of society, is regulated by principles, and nothing can shock the habits and rules of epicureanism more than the violation of certain rules in the succession and combination of dishes. It is maintained that perfection in the art of cookery and the observance of its principles at table is the surest mark of a nation's attainment and of the highest state of civilization.

Of all the organs of sense, that whose nervous mechanism appears to be most easily deadened by excessive action is that of smelling. The most delightful odors can only be enjoyed occasionally, and for short intervals. The scent of the rose, or the still more delicate odor of the magnolia, can be but fleeting pleasures, and are destined only for occasional enjoyment. He who lives in the garden cannot smell the rose, and the woodcutter in the southern forests is insensible to the odor of the magnolia.

Persons who indulge in the use of artificial scents soon cease to be conscious of their presence, and can only stimulate their jaded organs by continually changing the objects of their enjoyment.

One of the most curious and most incomprehensible illusions of the senses is the singularly erroneous estimate which we make of the number of objects of any kind that are presented to us. A striking example of this is presented by the impression made upon the eye by a view of the firmament on a clear starlight night. The number of visible stars are always immensely over-estimated. Although it be true that the stars are, strictly speaking, countless in

number, yet the number distinctly seen by the naked eye at any one time, unaided by the telescope, is not great. Any one can satisfy himself of this by examining any good map of the stars; yet, when we look at the firmament on a clear night, these objects appear to be inconceivably numerous. This illusion is dispelled by examining the heavens through the most ordinary telescope, or even by looking through a long tube, which will limit the view at any one moment to a small portion of the firmament. On the entire sphere of the heavens there are not above twenty stars of the first magnitude, and it is seldom that as many as six or eight of these can be seen at once. The number of stars of the second magnitude does not exceed fifty, and of these twenty are seldom seen at any one time. The stars of the third magnitude may amount to about two hundred, half of which only can be at the same time above the horizon. The smaller stars are much more numerous, but they are discernable with difficulty, and do not produce upon the mind the impression of multitude that we conceive.

I have explained, on another occasion, that the membrane of the eye, which is affected by light, retains the impression it has received for about the tenth of a second after the cause which produced the impression has been removed. When a lighted stick is whirled in a circle, the circle will appear to be one continuous line of light, because the eye retains the impression which the light produces upon it at any point in the circle until the stick returns to that point. The light is, therefore, visible at the same time at every point of the circle.

Ingenious optical toys are constructed, the effects of which are explicable on these principles. The same object is painted on the several divisions of circumference of a circle in a succession of different attitudes, and while the eye is directed to the highest point of the circle, through an opening made for that purpose, the circle is made to revolve, and the object passes before the eye in a succession of different attitudes. If the velocity with which the circle turns be such that the eye shall retain the impression of the object in one attitude until its picture in another attitude comes into view, it will have all the effect of a moving object. Waltzing figures and other similar devices are painted on circular cards and mounted, so as to give these effects.

If the eye is supplied with no external means of knowing the distance of a visible object, it estimates that distance by its apparent magnitude, and if there be any means of causing the magnitude of the same objects to undergo a gradual change, the impression on the spectator is as if the object advanced to or receded from him. It is upon this principle that the exhibitions of phantasmagoria are made. The image of an object is formed on some surface prepared to receive it, the apartment being elsewhere in complete darkness, so that the observer has no means of knowing where the image is formed. The magic lantern has a power, by advancing it gradually toward the surface, to diminish the size of the image indefinitely, and by drawing it from the surface to augment it. The spectators, therefore, see the images gradually increase and diminish, and imagine it gradually to approach to and recede from them.

PROTECTION FROM LIGHTNING.

Danger proportionate to the Magnitude, not to the frequency of the Evil.—Ancient Methods of averting Lightning.—Persons in Bed not Secure, as some think.—Augustus's Seal-skin Cloak as a Lightning Protector.—Influence of Color on the Electric Fluid.—Tiberius's Crown of Laurel as a Lightning Protector.—The Danger of taking Shelter beneath Trees.—Futility of taking Shelter in Glass Cages.—Metal about the Person destroyed by Lightning.—Metal Appendages to be laid aside.—Lightning Explosions occur at the Points where it leaves or enters a Metal.—Part of a Room which is most Safe.—Lightning more likely to discharge among a Crowd than on a single Individual.—Influence of the Vapor of Transpiration, &c.—Certain Individuals are comparative Non-Conductors.—Thunder-Clouds have been traversed with Impunity.—Thunder-Storms below the Place of Observation.—PARATONNERRES, or Lightning Conductors.—Lightning Conductors protective even when no Flash strikes them.—Sparks at the Interval where a Conductor is disjointed.—Lightning Conductors drain off the Electricity of Clouds.—Sparks or luminous Aigrettes on the Point of Conductors.—More frequent Occurrence at Sea.—Influence of Elevation of a Paratonnerre.—Experimental Illustration.—Electric Kites.—Captive Balloons as Paragrèles and for Meteorological Research.—Pointed and blunt Conductors.—Quantity of Lightning drawn down by a Conductor.—Mr. Harris's Conductors for Ships.—Assumed Extent of the protecting Power of a Paratonnerre.—Not based on experimental Grounds.—Cases against its general Application.—Lightning does not always strike the highest Points.—Lightning Conductors with many Points.—A Lightning Conductor must have sufficient Capacity.—A Lightning Conductor must be in good Connexion with the moist Sub-Soil.—Charcoal Beds to receive the Base of the Conductor.—Vicinal metallic Conductors.—Conductors of metallic Wire-Rope; Insulation not needed.—Conductors for Powder Magazines.—Efficacy of Lightning Conductors.—Lateral or divided Discharge defined; its Cause.—More readily obtained from Conductors than from Leyden Discharges.—Line or Lines of least Resistance.—Absolute Necessity of connecting the Conductor with vicinal Bodies.—Artificial Means of producing the Electrical Odor.—Chemical Changes.—Fusion.—Fulgurites.—Mechanical Effects.—Effects of conducting Bodies.

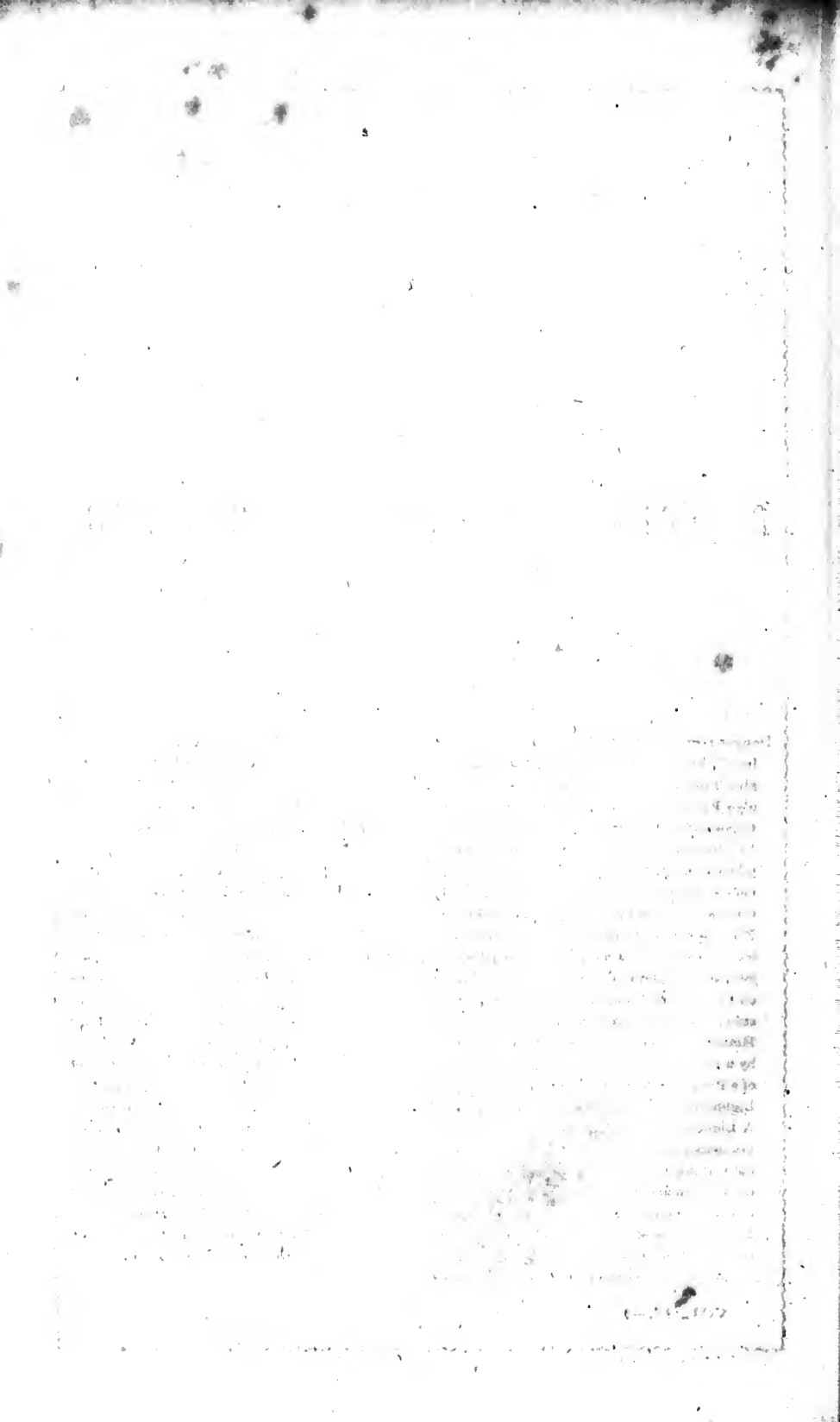

PROTECTION FROM LIGHTNING.

THE apprehension of danger from lightning, and the solicitude to discover and adopt means of security against it, are proportionate to the magnitude of the evils it produces rather than the frequency of their occurrence. The chances which any individual of the population of a large city incurs of being struck with lightning during a storm are infinitely less than those which he encounters in his daily walks of being destroyed by the casual fall of the buildings near which he passes, or by the encounter of carriages crossing his path, or from the burning of the house in which he lodges, or from a thousand other causes of danger to which he exposes himself without apprehension. Still, even those who possess the greatest animal courage are struck with awe, and affected more or less by fear, when exposed to the war of the elements in a violent storm; and there are none who, in such cases, will not willingly avail themselves of any means of protection which they believe to be availing. AUGUSTUS entertained such a dread of lightning that in storms he took refuge in caves, thinking that lightning never penetrates to any considerable depth in the ground.

Strong fear, operating on ignorance, has prompted, in times past and present, a multitude of absurd and unavailing expedients, among which, nevertheless, chance seems to have flung some in which analogies to the results of modern science are apparent. When a cloud menaced thunder, *the Thracians shot their arrows at it*. The arrows being metal, were conductors, and, being pointed, had the virtue of attracting lightning. PLINY states that the *Etruscans* had a secret method by which they could draw lightning from the clouds, and guide it at their pleasure. NUMA possessed the method, and TULLUS HOSTILIUS, committing some oversight in the performance of the ceremony, was himself struck. For NUMA substitute FRANKLIN, and for TULLUS, RICHMANN, and the Roman legend is converted into a true historical record of the last century.

It was formerly believed that persons in bed were never stricken by lightning; and a modern meteorologist, Mr. Howard, apparently favors such an

idea, by relating two cases in 1828, in which beds were completely destroyed by lightning, while the persons who lay in them were uninjured. Against this, however, many contrary instances may be cited. On the 29th of September, 1779, Mr. *Hearthley* was killed in his bed, by lightning, at *Harrowgate*, while his wife, who lay beside him, escaped. On the 27th of September, 1819, a servant was killed in her bed at *Confolens*, in France. In 1837, a house was struck with lightning at *Kensington*, near *London*, where a man and his wife were killed in their bed.

The Romans believed that *seal's skin* was a preservative against lightning; and tents were made of this material for timid persons to shelter under in storms. *AUGUSTUS* was always provided with a seal's skin cloak. However ineffectual may be such an expedient, experience abundantly proves that the material of the dress is not without considerable influence on the course which lightning follows, and may, therefore augment or diminish the peril of the wearers. When lightning struck the church at *Château-neuf-les-Moutiers*, during the celebration of mass, of the three priests who officiated at the altar, two were struck dead and the third was uninjured. The vestments of the last were of *silk*.

There are some well-attested facts which indicate a relation between *color* and the movements of the electric fluid. Three cases are cited in which horses and oxen having white spots were struck by lightning, and had all the white hair burned off, while the remainder of the hide remained unaltered.

It has been supposed that certain species of trees are proof against lightning, and never struck by it. *TIBERIUS* was accustomed to wear a crown of laurel, from the idea that lightning never struck it. Observations made in districts where extensive forests present all varieties of trees to the chances of the storm, afford no grounds for any certain conclusions on this subject.

When assailed by a storm in an open plain, the danger is greatly augmented by seeking the shelter of a tree. Experience and theory combine to prove this. The position of greatest safety is such a distance from the tree that it shall act as a conductor, diverting the lightning from the place assumed for safety. A distance of half a dozen yards may serve for this purpose.

Glass, being a non-conductor of electricity, is generally supposed to have a protective virtue. Thus it has been presumed that a person enclosed in a cage of glass exposed to a thunder-storm would be in absolute safety. This is proved to be a fallacy by many examples of lightning striking and penetrating the panes of windows and the frames of conservatories.

Nothing is more clearly established than that pieces of metal of any kind, carried about the person, augment the danger of being struck by lightning; and this increase of peril is greater in proportion to the magnitude of the metallic appendages. That this material principle, illustrating, as it does, one of the elementary laws of electricity, may be appreciated as fully as it ought to be, we shall here cite some of the numerous recorded examples of it.

On the 21st of July, 1819, lightning struck the prison of *Biberac*, in Swabia, and, passing into the grand hall, struck an individual prisoner who was one in a group of twenty; the nineteen others were untouched. This individual was a brigand chief, who, being under sentence, was *chained round the waist*.

When *SAUSSURE* and his party were at *Breven*, in 1767, the metal band and gold button on the hat of *M. JALLABAT* emitted sparks.

CONSTANTINI relates, that, in 1749, a lady, wearing on her arm a gold bracelet, raised her hand to shut the window during a thunder-storm; the bracelet suddenly disappeared; not the slightest trace of it remained. The lady was slightly wounded.

Brydone relates that a lady of his acquaintance, *Mrs. Douglas*, sitting at an

open window, during a storm, had her bonnet completely destroyed, but suffered no injury in her person. He accounts for this by the wire of the form of the bonnet attracting the lightning.

These, and many other instances which might be mentioned, sufficiently prove that safety is best consulted in time of storm, by laying aside all metallic appendages of the person, such as chains, watches, ear-rings, hair ornaments, &c. The source of the greatest danger is in the bars or plates of steel which are used in the corsets of females, and which ought to be abandoned by all ladies who do not desire to invite the approach of lightning.

It has been already shown that when lightning passes along a line of conducting matter, the only points where explosion takes place and damage ensues, are at the parts where lightning enters and leaves the conductor; and as a necessary consequence of this, all interruption of continuity in any part of a conductor or series of conductors is attended with explosion and corresponding damage. Since, then, the bodies of men and animals afford a free passage to the electric fluid, it may be expected by analogy that when lightning is transmitted through a chain of animals, either in mutual contact or connected by conductors, the chief if not the only injury would be sustained by the first and last individuals of the series. This principle is accordingly supported by the results of experience. The following instances will illustrate it:—

On the 2d of August, 1785, a stable at *Rambouillet* was struck by lightning. A file of thirty-two horses received the fluid: of these, the first was laid stiff dead, and the last was severely wounded. The intermediate thirty were only thrown down.

On the 22d of August, 1808, lightning struck a schoolroom in *Knonau*, in *Switzerland*. Five children read together on the same bench: the first and last were struck dead, the other three only sustained a shock.

At *Flavigny (Côte-d'Or)* lightning struck a chain of five horses, killing the first two and the last two, the middle horse suffering nothing. At a village in *Franche-Comté*, lightning struck a chain of five horses, killing the first and last only. At *Praville*, near *Chartres*, a miller walked between a horse and a mule loaded with grain: lightning struck them, killing the horse and mule. The man was unhurt, except that his hat was burnt and his hair singed.

The danger from lightning during storms may be lessened by observing some precautions suggested by the known properties of the electric fluids. Chimneys often afford an entrance to lightning, the soot which lines them being a conductor. Keep, therefore, at a distance from them. Avoid the neighborhood of all pieces of metal, gilt objects, such as the frames of glasses, pictures, and chandeliers. Mirrors, being silvered on the back, augment the danger. Avoid the proximity of bell-wires. The middle of a large room in which no chandelier is suspended is the safest position, and is rendered still more so by standing on a plate of glass, or a cake of resin or pitch, or sitting on a chair suspended by silken cords.

The danger of being struck with lightning is augmented by being placed in a crowd of persons. The living body being a conductor of electricity, a connected mass of such bodies is more likely to be stricken, for the same reason that a large mass of metal is more liable than a small one.

Besides this, the vapor which arises from the transpiration of a crowd of persons, rising through the air, plays the part of a conductor, and attracts the lightning in the same manner as a metallic rod, though in a less degree. For these reasons, those who are very solicitous for their personal security, should not remain in churches, theatres, or other places of public assembly, during a storm. The same causes expose flocks of sheep and herds of cattle or horses collected together in the same stable, to increased danger. Barns and granaries are lia-

ble to exhale vapor in such quantities as to produce a column of conducting matter above them, and are, for this reason, often struck by lightning, when not provided with the means of protection afforded by PARATONNERRES.

It sometimes happens that lightning falling among a crowd selects an individual through whose body it passes to the ground, neglecting the rest, and this without any discoverable cause.

A case has been already mentioned in which this occurred from the influence of a mass of metal concealed behind the wall against which the person who suffered stood. But cases are not wanting in which we are compelled to admit that different individuals are endowed with the conducting power in different degrees, and, therefore, that the lightning strikes by preference the best conductor. The results of experiments with artificial electricity corroborate this, for in transmitting the electric discharge through a chain of persons, it has sometimes happened that one individual in the chain stops the fluid. From some unknown peculiarity of his organization, his body is a non-conductor. If, then, it be ascertained that in some, though very rare instances, individuals are found who are *non-conductors*, analogy leads to the inference that different individuals have the conducting quality in different degrees.

The fear engendered by the proximity of the cloud in which lightning is elaborated, is founded, not on any distinct and explicable principles, but on a vague impression that the chances of damage are augmented as we approach the cause of danger, whatever that cause may be. If, then, the risk of injury be admitted to increase as the distance from the thunder-cloud is diminished, it would follow, by necessary inference, that destruction would be inevitable to those whose temerity or misfortune might place them actually within the dimensions of the cloud. Experience, however, does not justify this. On the contrary, thunder-clouds have been repeatedly traversed with impunity. In August, 1770, the abbé Richard, passed through a thunder-cloud on the small mountain called *Boyer*, between *Chalons* and *Tournus*. Before he entered the cloud the thunder rolled as it is wont to do. When he was enveloped in it, he heard only single claps with intervals of silence, without roll or reverberation. After he passed above the cloud, the thunder rolled *below him* as before, and the lightning flashed.

The sister of M. Arago witnessed similar phenomena between the village of *Estagel* and *Limoux*; and the officers of engineers engaged in the trigonometrical survey repeatedly experienced the same occurrences on the *Pyrenees*.

The *paratonnerres*, appended to buildings and ships, consist of a pointed metallic rod, attached to, and projecting upward from the highest point of the structure placed under their protection. The lower end of this rod is connected with a series of other metallic rods, or with a metallic chain, which is continued to the ground. If the paratonnerre be applied to a building, the series of rods being attached to the walls and carried to the ground, must be continued to such a depth, and brought to such a position, that its inferior extremity shall either be immersed in water, or in soil which is in a permanent state of moisture. The water, or moist soil, possessing the conducting power, receives the electricity from the extremity of the rod without explosion; but if the rod terminated in dry earth the fluid would escape from the extremity, or worse still, from some other part of the series of rods, with an explosion, and would damage whatever bodies might be adjacent to it. If it be applied to a ship, the pointed rod is attached to the point of the main-top-mast, and the lower end of the rod is connected with a chain which is carried down the mast and rigging over the side of the vessel, and finally plunged in the sea. The highest point of the rod being liable to be heated by lightning, and to be oxydated, is formed of platinum, or gilt, so as to restrict oxydation.

That paratonnerres exert their protective power only when lightning strikes the structure over which they preside, is an error easily corrected, by immediate experiment, independently of the refutation it might receive on theoretical grounds. Let the continuity of one of these apparatuses be broken, by separating any two bars of the series, so that their ends, instead of being in immediate contact, shall be distant by the eighth or tenth part of an inch from each other. When stormy clouds pass over the apparatus, a continual stream of electrical light will be visible in the interval between the separated points of the bars. If their distance be increased to an inch, sparks will be observed to pass between them, in rapid and continual succession, accompanied by detonations as loud as the report of a pistol.

Captain Wynne, who commanded a British frigate, lately observed, during a storm, at a point where, by accident, an interruption of the metallic continuity of his paratonnerre occurred, an almost unintermitting succession of sparks, which continued for two hours and a half, the whole interval during which the thunder-clouds were over the vessel.

It is apparent, then, that paratonnerres are not merely instrumental in saving a structure when lightning actually falls upon it, but they also possess a preventive power, and gradually and silently disarm the clouds by draining the electric fluid from them; and this process commences the moment the clouds approach a position vertically over the paratonnerre.

The explanation of these phenomena is easy, when the principles which govern the movements of the electric fluids are understood. From the moment that a stormy cloud passes over a paratonnerre, and comes within the range of its influence, the electricity of the cloud decomposes the natural electricities of the rod, attracting that of the contrary name, which is accordingly accumulated at the point, and repelling that of the same name, which is driven into the crust of the earth, or into the water with which the lower extremity of the paratonnerre is in communication. The electricity of the contrary name, collected at the point, soon acquires so great a tension that it overcomes the restraining pressure of the air, and escapes in a jet, which may often be seen in the dark, in the form of a luminous *aigrette*, issuing from the metallic point. The fluid which thus escapes, enters into combination with the fluid of a contrary name, with which the cloud is charged, and neutralizes it.

On land, and especially in cities, numerous objects are presented to the electricity of the air, which have this tendency to neutralize it, and marked effects, such as that now referred to, are of more rare occurrence; but at sea such appearances are common, as is proved by the familiarity of all seamen with the fire of *St. Elmo*, *Castor and Pollux*, and *Helen*, already mentioned. Experience proves that, *cæteris paribus*, the more elevated a paratonnerre is, the more efficacious it will be.

This is easily verified by immediate experiment. The influence of a paratonnerre, or what is the same, the rate at which it neutralizes the electricity of the air, is estimated by the number of sparks which pass in a given time through a space of a given length—suppose, for example, an inch—by which its metallic continuity is broken. It is found, that, according as the elevation of the point of the rod is increased, the number of sparks transmitted undergoes a corresponding increase. The height of the point being preserved, the number of sparks transmitted in a given time is diminished by bringing other pointed conductors near it, and still more so if these conductors are more elevated.

The increased efficacy obtained by augmenting the elevation of the metallic point of a paratonnerre, is strikingly illustrated by the experiments which the contemporaries and successors of FRANKLIN made with kites. ROMAS, having elevated kites by means of cord lapped with metallic wire, like the base-strings

of a harp or violin, drew from the lower extremity of the cord flashes of lightning from three to four yards long, and an inch in thickness, accompanied by a report as loud as that of a gun. It was remarked on several occasions that thunder and lightning ceased when the fire was thus drawn from the cord. By the same expedient thunder-clouds were drained of their fire, and converted into common clouds, by Dr. LINING, of Charleston, and M. CHARLES.

M. Arago proposes this expedient for averting the calamitous effects of hail-stones which are so great a scourge to the agriculturist in several parts of France. As the formation of hail is undoubtedly an effect of the sudden disturbance of the electric equilibrium of the clouds, if the electric fluid could be quietly and gradually drawn away, hail would be altogether prevented. Captive balloons might be substituted with advantage for kites, since they could be elevated in a calm, and maintained at any required height. By such means a multitude of experimental researches in electro-meteorology could be prosecuted. The atmosphere could be *sounded* and the clouds themselves *sounded*, and their electrical contents submitted to careful and deliberate examination.

The contest respecting pointed and blunt conductors, which was maintained about the middle of the last century, has been already noticed. Although the electrical laws, which have since then been so fully and clearly established, can leave no doubt as to that question, an experiment decisive of it made by Beccaria may be mentioned here. This philosopher placed on the roof of *San Giovanni-di-Dio* at *Turin*, a bar of iron, at the lower part of which was such an interruption of continuity as to produce sparks when electricity passed along it. The metallic point at the top was moveable on a joint, and connected with a silken cord, by drawing which the observer could at pleasure convert it into a *blunt* conductor, or restore to it the pointed form. In a storm, so long as the point was presented upward, a stream of sparks was seen at the place where the breach of continuity was provided, but the moment it was converted into a blunt conductor, the sparks either disappeared altogether (which generally happened), or passed in much less rapid succession.

An ingenious calculation of the *quantity* of lightning drawn from the clouds by paratonnerres, has been made by M. Arago. He states that in an ordinary storm a hundred sparks would be transmitted through a small break of continuity in the conductor of which the combined effect would be sufficient to kill a man, and these would pass in ten seconds. As much lightning would therefore pass per minute as would destroy six men, as much per hour as would kill three hundred and sixty men. He calculates in this way that the paratonnerres erected by Beccaria on the palace of Valentino, combined with the effects of the pointed parts of the roof, must take as much lightning per hour from the clouds as would be sufficient to destroy three thousand men.

The quantity of electricity which pointed conductors neutralize, may be imagined from the following circumstance: The British frigate *Dryad*, provided with a paratonnerre (constructed according to the method proposed by Mr. Snow Harris, by fixing to the mast itself narrow plates of thin copper), was several times exposed to violent tornadoes off the coast of Africa. The electric fluid was seen on every part of these copper plates in such quantity as to produce around them a sort of luminous atmosphere, accompanied by a noise like that of water boiling violently.

In the practical adaptation of paratonnerres, the determination of the range of their protective influence is a problem of great importance. The physical section of the Academy of Sciences at Paris, being consulted by the minister of war on this point in 1823, adopted the estimate of M. Charles, and assumed that a circle of double the height of the rod would be protected.

If this estimate be interpreted with geometrical rigor, it would appear that

the space over which a pointed metallic rod extends its protection, is a *CONE*, of which the vertex is the point of the rod, of which the rod is the axis, and of which the section made by any horizontal plane is a circle, whose diameter is four times the distance of such plane from the point of the rod.

This estimate, which is evidently empirical, and of which the experimental grounds are not stated, requires much elucidation before it can receive unqualified assent. Does the conductor extend no protection to any surrounding points at the level of its own points? To what depth below the point does the surface of the cone bounding the protected space extend? or what is the position of the base which limits the protected space taken in the vertical direction downward? Does the same form of cone limit the protected space for all kinds of structures? Is the angle of the cone affected by the presence of large masses of metal, such as the guns in a battery, or the machinery used in certain large factories, or the armament of a ship-of-war, or the engines of a large steamship?

Theory affords no grounds for the law laid down by M. Charles, and observation is not wanting to show its fallacy.

The foremast of the ship *Endymion* was struck by lightning at Calcutta, in March, 1842. The mainmast, not fifty feet distant, had a chain-conductor, which, according to the above law, would protect a circle of one hundred and fifty feet diameter.

The bow of the ship *Etna* was struck at Corfu, January, 1830, although the mainmast had a chain-conductor. Other cases of similar character have occurred to buildings on shore, one of which has very recently been communicated to the French Academy. M. Arago, and many with him, were unwilling to admit so vague a law, and experience confirms their decision. To protect an extensive building, several paratonnerres would be necessary, and the less the height of each, the greater should be their number, which, as well as their position, must be determined by the condition that no part must be more distant from the foot of the rod than twice its height.

Although lightning falls *generally* by preference on the highest points, of buildings, it does not *always* do so. Many cases are recorded in which, without damaging the summit, it has struck at the middle of the height. In some cases it has been *seen* distinctly to move in the horizontal direction, and strike the side of a steeple. Cases are also cited in which it has entered by the ground-floor, where it has struck persons and caused their deaths, doing slight damage to the first floor, and none to the higher parts of the house. Such facts suggest the utility of paratonnerres with points presented laterally and obliquely.

In some countries the superior extremities of paratonnerres are formed into a group of points, radiating in various directions like a star. This method has been suggested by the supposed advantages of horizontal and oblique points. Experience has not yet supplied data on which any certain judgment can be formed as to the efficiency of this expedient.

The rod of a paratonnerre, by which it is intended to conduct the electric influence to or from the earth, should be of such thickness that it may not be fused by the most powerful current of electricity which is likely to pass through it. Experience indicates that this purpose will be sufficiently attained if it be a square of three quarters of an inch in the side, or a circle of the same diameter. Toward the base, an increased thickness is sometimes given to it, with a view to its stability. Paratonnerres are sometimes painted to protect them from rust, and lampblack is selected as the material of the paint, in consequence of its conducting power.

It has been already stated, that the inferior extremity of the paratonnerres

ought to be immersed in water or in wet soil. If it is necessary to add, that if it be in water, an artificial cistern will not serve the purpose, as it is in general stanch, and enclosed on every side by non-conductors of electricity. Examples of the inefficiency of such a termination to the conductor are not wanting. The cathedral of Milan was struck by lightning on the 9th of June, 1819, and the lighthouse at Genoa, on the 4th January, 1827, and in both cases damage was sustained, notwithstanding the paratonnerres. On examination, it proved that the inferior extremities of these apparatus were immersed in artificial cisterns.

To increase the surface of contact of the conductor with the ground it has been proposed to make it diverge into several points at its lower end, or to flatten it into a thin broad plate. It has also been proposed to immerse it in a bed of charcoal, previously raised to a red-heat, this being a good conductor of electricity.

When several paratonnerres are erected on the same building, each should communicate with the ground by the nearest and most direct route, the fluid by such means passing more freely through them. Their efficiency will be still more augmented if they communicate with each other, and with all the metallic parts of the roof.

Flexible metallic wires combined together so as to form a metallic rope, such as are sometimes used for suspension bridges, have been proposed as substitutes for rigid bars in paratonnerres as being more capable of adapting themselves to the inequalities of buildings, and less liable to lose their metallic continuity by the effects of rust.

When iron beams or cramps are used in the construction of a building, they are sometimes carefully separated from the paratonnerres by non-conductors, such as resin or pitch. If the paratonnerres be properly constructed, this precaution is unnecessary. The lightning will go to the earth in preference to any lesser mass of conducting matter.

In the adaptation of paratonnerres to powder-magazines, danger is supposed to arise from the electric sparks, which issue at parts of the conductor where minute and imperceptible breaches of continuity may take place. The sparks, catching the powder which may be accidentally scattered on the projecting parts of the building, or lodged in crevices by the wind, may produce fatal effects. For this reason it has been proposed that the paratonnerres for such structures should not be erected *on* the building, but that they should be planted in the ground *near it*. In that case, the practical principle already explained, by which the range of the protective influence of the conductor is limited, must be attended to, and a sufficient number of paratonnerres be placed round the building to defend every part of it.

With the view to prove the efficacy of paratonnerres, independently of all reasoning based on theory, M. Arago has collected a number of facts, which are too interesting, and have too strong a bearing, to be passed without some notice here. We shall, therefore, briefly state the most important of them.

The temple at Jerusalem stood from the time of Solomon till the year 70 of the Christian era, a period of above 1000 years. It was completely exposed to the violent storms incidental to Palestine. *It was never struck by lightning.* Neither the Bible nor Josephus mentions any such fact, which, if it had occurred, must have strongly excited attention, and certainly been recorded. Besides, it was *covered with wood* both within and without, and must have been set fire to if it had been struck. Michaelis rightly infers that, in the course of ten centuries, in the midst of continual thunder-storms, and ages before the invention of paratonnerres, this building *was never struck by lightning.* The cause is easily explained. By a circumstance apparently fortuitous, the temple was

provided with paratonnerres similar in principle to those of Franklin! The roof of the building was formed of cedar, covered with thick gilding, and from end to end was adorned by a row of long lances of iron or steel, pointed and gilt. According to Josephus, the architect intended these numerous points to prevent birds from defiling the roof. The several fronts of the building were constructed throughout their whole extent of wood thickly gilt. Finally, under the porch were cisterns, into which the waters of the roof were discharged through metallic pipes provided for that purpose. It appears, therefore, that the roof was protected by a vast number of pointed metallic rods communicating with a superabundance of metallic conductors, which were continued to cisterns of water below, so that the most carefully-constructed paratonnerres of the present day could not confer greater security.

The church of the château of Count Orsini, in Carinthia, standing on an eminence, was so often struck by lightning, and so many fatalities occurred in consequence, that, at length, the celebration of divine service was discontinued there in summer. In the course of the year 1730 the steeple was entirely destroyed by lightning. After it was reconstructed, it continued to be struck four or five times a year. In 1778 it was entirely demolished, and being immediately rebuilt, it was now supplied with a paratonnerre. From that time the building was free from damage by lightning. In five years it was struck but once, and then the fluid was conducted to the earth by the paratonnerre, without injury to the church.

In 1750 and 1763 the Dutch church at New-York was struck by lightning, and sustained great injury. It was after that provided with a paratonnerre, and, being again struck in 1765, sustained no injury.

The church of St. Michael, at Charleston, used to be struck and damaged once at least in two or three years. It was provided with a paratonnerre, after which it sustained no damage.

Before the time of Beccaria, the palace of Valentino, at Turin, was constantly struck by lightning and damaged. Beccaria erected paratonnerres upon it, and the damage ceased.

The tower of St. Mark, at Venice, was, until the year 1776, constantly struck by lightning, and sustained occasionally great damage. In that year a paratonnerre was placed upon it, and no damage has occurred since.

Mr. Snow Harris states that, of six steeples in Devonshire, all have been within a short period struck by lightning. One only sustained no damage, and that one alone was provided with a paratonnerre.

The present lecture would be incomplete, were we to close it without advert- ing to the phenomena termed "the lateral discharge;" it bears intimately on the practical part of the subject, and will enable us at the same time to present certain illustrations of the action of electricity which have not been included elsewhere. When a portion of the discharge from a prime conductor, for instance, or a Leyden jar, leaves the course marked out for it to pursue a side-path, the spark consequent on such deviation is termed the lateral spark; it is, in fact, a spark produced by the division of the discharge. It may be shown in the following manner: Let a powerful electrical machine be in action, and sparks be thrown on a wire held by an insulated rod, but having its extremity connected with the earth; on applying the knuckle, or a brass ball, to any part of this wire, sparks may be obtained; not that the wire is incapable of carrying away the whole charge safely, but because of the repulsive action of the electricity, by which it has a tendency to spread over the surface of conductors, and take the widest path it can. The tendency is even developed when the side-path only lasts for a part of the course to the earth, and the electricity has to return again to its original wire, for, if the insulated discharging-rod have

one ball placed very close to one part of the wire, and the other ball very close to another part, a spark will appear at each ball. In this case, it is evident that the metal of the discharging-rod was of no ultimate service in furnishing a side-path as a thoroughfare to the charge, but merely relieved the portion of the wire intervening between the balls. The same effects occur during the discharge of a Leyden battery, especially when it is insulated. But not only is it possible to obtain a spark from the wire itself, but even from any metallic system with which the wire is connected. We have ourselves obtained it from gas-burners in all parts of a very large building, when the wire was connected with the gas-pipes in one part.

This spark is much more readily obtained from the prime conductor than from the Leyden discharger, obviously on account of the low intensity of the latter, for it is an effect of intensity alone which enables electricity to pass at all through the air. Voltaic electricity, of which we shall hereafter speak, is abundant in quantity, but of such low tension as not to pass at all *before contact*, unless from a very extensive series of the pile.

Now the law which regulates all discharges is, that they pursue the *line* or *lines of least resistance*. When, therefore, the sum of two paths, including the interval or intervals of air, involves *less* resistance than does the one original path, the division occurs; when it involves *greater* resistance, it does not occur; and this readily explains the greater facility for lateral discharge displayed by the electricity from the conductor, as contrasted with the Leyden flash. At the very outset the former will overcome the resistance of many inches of air, while the latter is insulated by less than one inch, and hence the former has, throughout its brief existence, a power greatly exalted over that of the other. And this path, or paths, is not a mere matter of choice, determined on by the charge in its progress onward; it is a course entirely marked out by the action of induction, antecedent to the original discharge. Indeed, it is the mere fact of the inductive action being able to find a path offering a resistance which the charge can overcome that first causes the discharge to take place. There are other instructive facts connected with the lateral discharge, for which we have not space here, and to which the reader must refer.*

* *Vide* Naut. Mag., Jan., 1840; Report of Committee of House of Commons on Lightning; Ann. Elect., 1849. Proceed. Elect. Soc., 1842; Harris, on Thunder-Storms, 1843.

MAGNETISM.

Magnetic Attraction and Polarity.—Magnetic Meridian, Variation.—Dip of the Magnetic Needle.—Magnetic Attraction known to the Ancients.—Invention of the Mariner's Compass of uncertain Date.—Discovery of the Variation.—Tables of Variation constructed.—Robert Norman discovers the Dip.—Invention of the Dipping Needle.—The Variation of the Variation discovered.—Influence of Magnets on soft Iron observed.—Polarity of Magnets observed.—Construction of artificial Magnets.—Magnetism imparted to Iron by the Earth.—Laws of Magnetic Attraction discovered by Coulomb.—Methods of making artificial Magnets—consequent Points.—Knight's improved Method.—Duhamel's Improvement.—Coulomb's Researches on artificial Magnets.—Influence of Heat on Magnetism.—Local and periodical Changes of the Variation.—Diurnal Variation.—Cassini's Observations at Paris.—Advancement of Magnetic Geography.—Magnetic Equator.—Magnetic Poles.

1877

1877
1878
1879
1880
1881
1882
1883
1884
1885
1886
1887
1888
1889
1890
1891
1892
1893
1894
1895
1896
1897
1898
1899
1900

MAGNETISM.

THE substances endowed with magnetism exhibit that property by three distinct effects :—

1. They attract iron and all ferruginous matter.
2. Two bodies endowed with the property of magnetism will attract each other at one part of their dimensions, and repel each other at another part. These contrary effects, belonging to opposite sides or ends, are called *magnetic polarity*.
3. When a magnet is placed on a vertical axis through its centre of gravity, on which it is free to revolve, the axis being between its poles, it will oscillate on each side of a certain determinate position, in which it will at length come to rest. When in this position, a vertical plane passing through the axis and the poles will be nearly, but not exactly, coincident with the plane of the meridian of the place in which the magnet is situate. For all magnets similarly supported, in the same situation, these planes will be parallel. This plane is called the *magnetic meridian*. The angle which the magnetic meridian makes with the terrestrial meridian is called the *variation* of the magnet.
4. If a magnet be placed on a horizontal axis passing through its centre of gravity at right angles to the magnetic meridian and between its poles, it will oscillate on each side of a certain determinate position, in which it will at length come to rest. When in this position, a plane passing through the axis and the poles of the magnet will not be horizontal, but will make a certain angle with a horizontal plane through the axis. This angle is called the *dip* of the magnet.

The power of the magnet, when placed on a vertical axis, to fix itself in the magnetic meridian of any place to which it may be transported, is called its *directive power*, and is the principle on which its application to navigation depends.

The attractive power of the magnet for iron was the property which was first observed. This property was known to the ancients, who gave to the

natural magnet (an oxide of iron) the name *Magnes* (*μαγνης*); derived, as is supposed, from Magnesia, a district of Lydia, in which the natural magnet was found in greatest abundance. It was also called *Lapis Heracleus*, from Heraclea, a city of Lydia. From some passages in ancient authors, it would seem that the force of magnetic attraction in very high degrees of intensity was then generally known. Pliny relates that Dinochares proposed to Ptolemy Philadelphus to erect a temple at Alexandria, the dome of which should be built of loadstone, so as to sustain in the air an iron statue of Arsinoë. Saint Augustine also alludes to a statue thus suspended in the air in the middle of the temple of Serapis, at Alexandria.

The polarity and directive powers of the magnet were discoveries of a much more recent date. The application of the magnetic needle to navigation must have immediately succeeded the first knowledge of its directive power, but the discoverer is unknown; and even the century which was honored by the invention of this most beautiful application of science to the uses of man is uncertain. It is stated, in the account of the Chinese empire by Du Halde, that the directive power of the magnet was used in that part of the globe, for the purpose of land-journeys, more than a thousand years before the birth of Christ. If such were the case, it is difficult to imagine that its use for sea-voyages should have failed to spread itself westward until two thousand years later. But, besides this, there are other reasons why little credit is to be given to the accounts which ascribe this invention to the Chinese.*

The earliest work in which the use of the mariner's compass is distinctly mentioned is a manuscript poem of the twelfth century, preserved in the Royal Library at Paris, the authorship of which is attributed to Guiot de Provins. Guiot was at the court of the emperor Frederick Barbarossa, held at Mentz in the year 1181.

Hansteen, in his work on the "Magnetism of the Earth," quotes an Icelandic historian, to show that the directive power of the loadstone was known a century antecedent to the date of this poem. That annalist, relating a voyage made in those seas, says incidentally, that "in those times, seamen had no loadstone in the northern countries." It appears that this writer, Arc-Frode, was born about the year 1068, and therefore probably published his account early in the twelfth century.

Cardinal Jacques de Vitri, who lived about the year 1200, speaks of the magnetic needle, in his "History of Jerusalem," as indispensable to those who make sea-voyages. It has also been said that it was first brought to Europe, from the East, by Marco Polo. It is, however, certain that Vasco de Gama, the Portuguese navigator, used the compass in his voyage to India in 1497.

Before it became the subject of accurate investigation, it was supposed that the direction of the compass was identical with that of the terrestrial meridian, and that it pointed due north and south. The discovery of its *variation*, and that the amount and direction of the variation are different in different places, is generally ascribed to Columbus in 1492. There appears, however, in a volume of MS. tracts in the University of Leyden, a letter dated 1269, by Peter Alsiger, in which the principal properties of the magnet are mentioned; and, among others, the *variation*. The honor of this discovery has also been ascribed to Grignon, a pilot of Dieppe, Sebastian Cabot, Gonzales, and others.

Accurate observations of the variation of the needle began to be made at Paris about the year 1550. At this time the variation was toward the east. It diminished in quantity, and became nothing in 1663; after which it passed to the west, increasing gradually till it attained a certain limit, after which it diminished.

* See Kircher, "De Magnete."

The Dutch navigators, in 1599, also constructed accurate tables of variation.

In the year 1576, Robert Norman, a mathematical instrument maker in London, discovered the *dip*. He found that the card of the compass near the north point was always depressed or inclined downward, so that he was obliged to put a counterpoise on the southern pole of the needle, to keep it level.

Mentioning this circumstance to some scientific friends, he was advised to construct a needle on a horizontal axis, and to observe the position to which this downward inclination would bring the northern pole. He accordingly constructed the first *dipping needle*, and found the *dip* to be about seventy-one and a half degrees.

The variation of the needle was accurately observed at London by Burrough, the friend of Norman, who found that in the year 1581 it was eleven degrees and fifteen minutes east. In the treatises extant by Norman and Burrough, no reference is made to any change, periodical or otherwise, either in the variation or the *dip*.

In the following century, the change to which the variation is subject was observed by Mair, Gunter, Gellibrand, and Bond. In the year 1599, Edward Wright wrote a work on the compass, which was published by Prince Maurice, lord high admiral of the United Provinces, in which the advantage of keeping registers of the variations observed on all voyages is urged. Thus the variation of the variation, not only as to time, but as to place, had at this period begun to receive the attention of those engaged in navigation.

When the influence of magnets on ferruginous matter came to be examined, it was soon apparent that they not only enjoyed the property of attraction, but that soft iron, so long as it remained within the sphere of their influence, actually acquired their own nature, and became magnetic also. When withdrawn from the influence of the magnet, the iron was found to return to its natural state. If, however, the iron, while influenced by the magnet, were twisted, filed, hammered, or submitted to other violence affecting its structure, it was then found to preserve the magnetism it had acquired, even when withdrawn from the magnet.

When iron filings were scattered over a sheet of paper under which a magnetic bar was placed, it was found that the metallic powder arranged itself in a particular manner, indicating different intensities of attraction in different parts of the bar. At a point near the centre the attraction seemed to cease, and to be augmented in each direction toward the extremities. The *polarity* of the magnet was consequently apparent. The points where the attraction seemed to be most intense were called the *poles*.

When a magnetic bar was broken in the middle, or at the neutral point, each part was found to acquire separate polarity, and, like the original magnet, to have two poles with neutral points intermediate. When magnetism was imparted by a magnet to a bar of iron, the former lost none of its own magnetic force. Hence it was inferred that, in giving magnetism, the magnet lost none of the magnetic fluid.

When a magnet was brought in contact with a piece of steel, the effect was first discovered to be feebly but gradually increased, until the steel itself became a permanent magnet, but that this might be effected suddenly by friction. Bars of steel, thus magnetized, were called *artificial magnets*.

Gilbert, in his work already referred to published in the sixteenth century, mentions that the fact of magnetism being imparted to a bar of iron by the earth itself, was first discovered by examining the rod of the weathercock of the church of the Augustines at Mantua.

The possibility of conferring magnetism on substances which are not ferruginous, was shown in 1733 by Brandt, who imparted magnetism to the metal cobalt. Cronstedt, in 1750, showed that nickel is also susceptible of this property.

After philosophers had become familiar with the attractions and repulsions, the polarity and directive power of magnets, their attention was directed to the establishment of a numerical measure of the actual amount of attractive or repulsive force which they exerted under given circumstances. For a long period, no estimate of this was formed more accurate than the weight which, by attraction, the magnet was capable of supporting attached to a piece of soft iron adhering to it. In 1780, Coulomb applied to magnetism those beautiful and accurate instruments of investigation which were so successfully employed in electricity and other departments of experimental physics, and determined by their means the intensities and laws of magnetic forces. Two methods of measuring the force exerted were practised by him, similar to those by which electric attractions and repulsions had been measured. These were, the balance of torsion, by which the amount of the force was estimated by the action of a twisted wire, or fibre of silk; and the observation of the number of oscillations which the attracted or repelled body made in a given time, on each side of the line of attraction or repulsion. By these means it was demonstrated that the force of a magnet was, *ceteris paribus*, in the direct ratio of the absolute intensity of the magnetism, and inversely as the square of the distance of the attracted or repelled body from it: a law identical in all respects with that by which electrical attractions and repulsions are governed. He also estimated, as he had done with electrified conductors, the distribution of magnetism on the surface of magnetized bars; and found that in bars of equal transverse section, of which the length was considerable compared with the magnitude of the section, the poles or points of maximum intensity were always at a distance of about an inch and a half from the extremities; and that, in very short bars, the poles are at one third of their length from the extremities, and that this latter position is the limit to which the poles approach as the bars are diminished in length.

In making artificial magnets, either by means of natural magnets or by other artificial magnets already made, the process first adopted was to rub the bar to be magnetized, from end to end, with one of the poles of the magnet by which it was to be magnetized. This method succeeded sufficiently well in magnetizing short needles; but, when applied to bars of any considerable length, it was attended with the liability of producing *consequent points*—that is, in fact, making the bar into a succession of magnets instead of a single magnet. Thus a certain portion of the entire length, measured from the extremity, would possess two poles and an intermediate neutral point; then another succeeding portion of the length would possess other two poles with another intermediate neutral point, and so on.

In 1745, Dr. Gowan Knight, of London, practised an improved method. He placed two strong bar magnets end to end in the same line the north pole of the one being in contact with the south pole of the other. Over them he laid the bar to be magnetized, its centre coinciding with the united ends of the two magnets, and its length laid along them. In this position the two magnets were drawn asunder, their poles passing under each half of the length of the bar to be magnetized. By this method the bar acquired much stronger magnetism than by that which had previously been practised.

Du Hamel further improved this process. The bar to be magnetized being placed between the pieces of soft iron, he took two bar magnets, and placing the north end of one and the south end of the other upon the centre of the bar,

and inclining them at an angle of about thirty degrees to it, he drew them upon it from the centre to the extremities, and repeated this process until the bar was strongly magnetized. This method was modified by Mitchell, who placed a series of bars to be magnetized in the same straight line, with their extremities successively in contact. He then placed two bundles of strong magnets perpendicular to them, with their ends resting upon them, the northern end of one bundle and the southern end of the other being downward. These two bundles of magnets, being attached to each other, were moved over the series of bars to be magnetized.

In 1789, Coulomb directed his investigations to the processes of producing artificial magnets. He showed that the susceptibility of bars of steel for magnetism depended conjointly on the temper of the steel and the force of the magnets, and that there was a certain limit to the magnetic force which a bar could receive. When a bar attained this limit, it was said to be magnetized to *saturation*.

The magnetic needles of ships' compasses being liable to great vicissitudes of temperature, it was a question of considerable importance to navigation whether heat affected the magnetic virtue. Gilbert was the first who observed that a magnet lost all its power when raised to a white heat, and on being cooled did not recover its magnetism. It was not, however, till a much later period, that the influence of heat on magnetism was submitted to accurate inquiry.

It was natural that the directive power of the magnet, and its application to navigation, should engross a large share of attention; and that the governments of maritime countries, more especially, should cause to be carefully and accurately observed all those phenomena by which that property was affected. The variation of the needle, and the changes periodical and local to which it is subject, were questions of the highest importance to national and commercial interests in every part of the world. So early as 1722, Graham had observed that in a given place the needle was subject to a *diurnal variation*, which was afterward ascertained with great precision in different parts of Europe. It was observed by Wargentin, secretary to the Swedish Academy, in 1750, and by Canton in London in 1756; and subsequently by Van Swieten, with nearly the same results. From all these observations it appeared that the north pole of the needle begins to turn westward at seven or eight o'clock in the morning, and continues to deviate in that direction till about two o'clock, when it becomes stationary, and soon begins to return eastward, arriving at the position it had in the morning at the same hour in the evening. Canton's observations showed that the amount of this deviation varied from seven to thirteen or fourteen minutes, being greatest at midsummer and least at midwinter, and increasing and decreasing gradually between these seasons.

More recently the same phenomenon has been observed by Colonel Beaufoy, Professor Hansteen, and others.

Cassini, who observed the diurnal variation of the needle at Paris, found that neither the solar heat nor light influenced it; for it was the same in the deep caves constructed under the Observatory in Paris, where a sensibly constant temperature is preserved, and from which light is excluded, as at the surface. In northern regions these diurnal changes are greater and more irregular; while, toward the line, their amplitudes are gradually diminished until at length they disappear.

The investigation of the changes produced in the direction of the needle, and in the intensity of the earth's attraction upon it, by change of place upon the surface, being a matter vitally important to commerce and navigation, has engaged the attention of all maritime and commercial countries, from an early

period in the history of the mariner's compass. In fact, what may be not improperly called *magnetic geography* has been, and still is, a subject of profound interest, as well to the merchant as to the philosopher.

It has been already stated that the discoverer of the *dip* found that at London a magnetic needle, free to move on an axis perpendicular to the magnetic meridian, presented its north pole downward, forming an angle of above seventy-one degrees. If the instrument be carried northward, it is found that the dip gradually increases; and, on reaching a certain region near the pole, the needle would become vertical, the dip being then ninety degrees, and its north pole pointing downward. At such a place, the common compass needle, moving on a vertical support, would lose its directive power, and rest indifferently in any position. A place where these effects would be produced is called a *northern magnetic pole*.

If, on the other hand, the dipping needle were carried toward the equator, the magnitude of the *dip* would be gradually diminished, until, on arriving at a certain region near the equator, the needle would become horizontal, and the dip would become nothing; and if the dipping needle could be carried round the globe, always following such a course as would allow it to retain its horizontal position, its course traced on the globe would be the *magnetic equator*.

The magnetic equator does not coincide with the equator of the globe, nor is it a great circle of the earth. It never departs from the equator, however, more than twelve or thirteen degrees.

If, after passing the magnetic equator, the dipping needle be carried southward, its south pole will dip or be directed downward; and this dip will increase in magnitude as the needle approaches the south pole. A place near that pole, where the needle becomes vertical, is a *southern magnetic pole*.

The first national project to determine the elements of magnetic geography was undertaken by the British government about the year 1700, when the celebrated Halley was commissioned to make a voyage with the view to collect the necessary observations. The results obtained by him were, however, deprived of the chief part of the advantages which ought to have attended them, because of the absence of uniformity in his instruments, and the neglect of making proper comparisons of them with others.

Since that period, observations have been made and recorded in all extensive voyages, and the data for the determination of the elements of this part of physical geography have been greatly augmented.

ELECTRO-MAGNETISM.

Electro-Magnetism very recently discovered.—Oersted's Experiments at Copenhagen.—The Law according to which the Needle is deflected.—The Law of Attraction and Repulsion of Electric Currents.—Supposes Electric Currents circulating round the Globe.—Arago shows that the conducting Wire has Magnetic Properties.—Needles magnetized by the Electric Current.—The Variation of the Attraction of the Current at different Distances determined.—Laplace reduces this Result to an analytical Formula.—The whole Body of Electro-magnetic Phenomena reduced to analytical Calculation.—Faraday's Researches.—Rotation imparted to Mercury by means of the Magnet and Electric Current.—The Multiplier or Galvanometer.—Its Construction and Application.—The Earth affects Electric Currents in the same Manner as it affects Magnets.—Ampere's Theory of Terrestrial Magnetism.—Researches of M. de la Rive.—Magnetizing Power of the Current at different Distances, and the Law of its Variation.—The Effect produced by transmitting it through Metals.—The undulatory Theory of Electricity similar to that of Light.—*Thermo-Electricity*.—Thermo-Electric Effects observed by Professor Seebeck.—His Experiment with Antimony and Copper.—Researches of Yelin, Marsh, and Cumming.—Oersted and Fourier construct a Thermo-Electric Pile.—Becquerel decomposes Water with such an Instrument.—Thermo-electric Scale of Metals.

ELECTRO-MAGNETISM.

THOSE capital experiments by which the science of magnetism has been reduced to the rank of a branch of electricity, by showing that all magnetical phenomena are merely effects of electrical currents modified by physical influences peculiar to certain substances, are of so very recent a date that they can scarcely be considered as yet falling within the scope of scientific history. Nevertheless, the important relations they bear to other parts of physics, the high generality of the phenomena themselves, and especially their susceptibility of being reduced to mathematical analysis, require that they should not be passed without some notice, even in a sketch so brief and rapid as the present. Since, however, it is proposed in these volumes to enter very fully into the details of the chief experiments which form the foundation of this part of electrical science, it will be sufficient here to notice concisely the chief results, in the order of their discovery, of those experimental investigations which may be regarded as forming the basis of the division of the science now denominated *electro-magnetism*.

At a very early period in the progress of electrical inquiries, indications were observed of a relation existing between electricity and magnetism. Ships' compasses had their directive powers impaired by lightning, and sewing-needles were rendered magnetic by electric discharges passed through them. The influence of electricity over the magnetic properties of iron had been sufficiently noticed to suggest to the clear and far-sighted mind of Beccaria a notion, which can scarcely be called a vague one, of that theory of terrestrial magnetism which may now be regarded as established on the basis of electro-magnetical phenomena.

No facts sufficiently clear and decisive to afford general conclusions were produced until the year 1820, which was signalized by the greatest discovery in physical science since the memorable invention of the pile.

Professor Oersted, of Copenhagen, had promulgated certain theoretical views on the subject of the relations of electricity and magnetism in the year 1807,

which obtained little attention, being unaccompanied by any new facts, and the community of science being then engrossed by the various and interesting experimental applications of the pile, and the magnificent series of discoveries which Davy was beginning to unfold. In 1820, however, Oersted supplied all that was wanting in 1807 to fix the attention of scientific inquirers—a capital experiment. In that year he announced the fact, that a magnetized needle placed near a metallic wire connecting the poles of a pile was compelled to change its direction; that the new direction which it assumed was determined by its position in relation to the wire, and to the direction of the current transmitted along the wire; that when the current was sufficiently strong, and the needle sufficiently sensitive, the latter always assumed a position at right angles to the wire; and that whenever the direction of the current along the wire is reversed, the needle, making half a revolution, reverses the direction of its poles, keeping still perpendicular to the wire. This discovery being made known, caused unqualified astonishment throughout Europe; the more especially, as all the attempts made before to trace the relation between the electric current and the magnet had been unavailing. The enthusiasm which had been lighted up by the great discovery of Volta twenty years before, and which time had moderated, was relumined, and the experimental resources of every cabinet and laboratory were brought to bear on the pursuit of the consequences of this new relation between sciences so long suspected of closer ties. The inquiry was taken up by Ampère, Arago, Biot, Savart, and Savary, in France; by Davy, Cumming, and Faraday, in England; and by De la Rive, Berzelius, Seebeck, Schweiger, Nobili, and others, in various parts of Europe.

Among these, in the inquiry now before us, Ampère has assumed the first and highest place. No sooner was the fact discovered by Oersted made known, than that philosopher commenced the beautiful series of researches which has since surrounded his name with so much lustre, and brought electro-dynamics within the pale of mathematical physics. On the 18th of September, 1820, within less than three months of the publication of Oersted's experiments in France, Ampère communicated his first memoir on electro-magnetism to the Academy of Sciences.

In this paper was explained the law which determined the position of the magnetic needle in relation to the electric current. In order to illustrate this, he proposes that a man should imagine the current to be transmitted through his body, the positive wire being applied to his feet and the negative wire to his head, so that the current of positive fluid shall pass upward from the feet to the head, and that of the negative fluid downward from the head to the feet. This being premised, a magnetic needle freely supported on its centre of gravity, so as to be capable of assuming any direction, and placed before him, will throw itself at right angles to him: the north pole of the needle pointing toward his left, and the south pole toward his right.

If the person through whose body the current thus passes turn round, so as to present his face in different directions, a magnetic needle, still placed before him, will have its direction determined by the same condition: the north pole pointing always to the left, and the south to the right.

In the same memoir were described several instruments intended to be constructed; especially spiral, or helical wires, through which it was proposed to transmit the electric currents, and which, it was expected, would thereby acquire the properties of magnets, and retain these properties so long as the current might be transmitted through them. The author also explained his theory of magnets, ascribing their attractive and directive powers to currents of electricity circulating constantly round their molecules, in planes at right angles to the line joining their poles; the position of the poles on the one side or the

other of these planes of revolution, depending on the direction of the revolving current.

On the 25th of the same month, Ampère communicated to the Academy another paper.* In this he delivered the results of his experiments on the reciprocal attractions and repulsions of electric currents acting on each other. He showed that two straight wires, along which currents are transmitted will attract or repel each other, according to the direction of the currents. Let a line be imagined intersecting both wires at right angles. If both currents move toward this perpendicular or both from it, the wires will attract each other; but if, while one of the currents moves toward this perpendicular, the other moves from it, then they will repel each other. If the wires be parallel to each other, they will attract or repel each other, according as the currents move in the same or opposite directions. If the wires be in the same plane, but not parallel, their directions will meet if produced: in this case they will attract each other, if the currents be both directed *toward* or *from* the point where their directions meet; and they will repel each other, if one current be directed toward, and the other from, that point.

In the same paper he proposes the hypothesis of currents of electricity circulating round the terrestrial globe, from east to west, in planes at right angles to the direction of the dipping needle, to account for the phenomena of terrestrial magnetism.

These researches proceeded with unusual celerity. On the 9th of the following month (October), three weeks after the reading of the last-mentioned paper, he presented another memoir to the Academy, in which he investigated the properties of currents transmitted through wires forming closed curves (*courbes fermées*), or complete geometrical figures.

While Ampère was proceeding with these researches, Arago directed his inquiries to the state of the wire through which the current was transmitted, more especially with a view to determine whether every part of its surface was endowed with the same magnetic properties. With this view he placed iron filings within the sphere of attraction of the wire, and found that they adhered to it, so as to form concentric rings upon it. The moment the connexion of the wire with the pile was broken, and the current was no longer transmitted along it, the filings fell off, and all attraction disappeared.

By a process inferred from the theory of Ampère, M. Arago succeeded in imparting permanent magnetism to needles and bars of steel by means of the electric current. This was accomplished by making a spiral of wire, through which the current was transmitted, while the needle or bar to be magnetized was placed within its coils. The position of the poles of the magnets thus made depended on the direction of the screw, or helix, formed by the conducting wire. If the wire formed a right-handed screw, the poles were placed in one direction; and if it made a left-handed screw, they were reversed. When the wire was made to form a succession of screws alternately right-handed and left-handed, the bar was magnetized with a corresponding series of *consequent points*. The same results were obtained whether the electricity transmitted through the wire proceeded from a Voltaic apparatus or from the common electrical machine.†

At the same time, or a very little later, and before the information of Arago's experiments reached England, Davy succeeded also in imparting magnetism to needles by the Voltaic current, and by common electricity; and also showed the effect of the conducting wire on iron filings.‡

* *Annales de Chimie et Physique*, tom. xv., 59-170.

† *Annales de Chimie et Physique*, tom. xv., p. 93.

‡ Letter to Wollaston, 12th of November, 1820, *Philosophical Transactions*, 1821.

M. Ampère, with the view of more completely developing the action of electric currents and magnets separately and on each other, contrived various methods by which wires, formed into parallelograms, circles, and other geometrical figures, could have a current transmitted round them, and be at the same time so supported or suspended as to be capable of assuming any position or direction to which their mutual attraction, or the attraction between them and magnets placed near them, or the influence of the magnetism of the earth upon them, might dispose them. These contrivances afterward became instruments by which many important experiments were made; the first of which was communicated to the Academy on the 30th of October, 1820. This was the fact, that a wire forming a plane geometrical figure through which the electric current is transmitted will, if free to move, dispose itself so that its plane shall be at right angles to the dipping needle.

On the same day, MM. Biot and Savart communicated to the Academy the results of experiments made with the view to determine the law of the mutual attraction and repulsion of electric currents. The results of these experiments were reduced to analytical investigation by Laplace, who showed that the law resulting from them was, that the attraction or repulsion of each elementary part of the current diminishes in the same ratio as the square of the distance of the object on which it acts increases: a law identical with that of all other modes of electrical attraction and repulsion. The effect of the obliquity of the current to the direction in which the force acted was also determined.

On the 4th of December following, M. Ampère read to the Academy the memoir which contains the reduction of the phenomena of electro-magnetism to mathematical analysis. He showed that all the various phenomena attending the action of magnets on each other, of electric currents on magnets, and of magnets on electric currents, and, in fine, of electric currents on each other, could be derived, by mathematical calculation, from formulæ expressing the action of two infinitely small elements of electric currents, acting on each other in the direction of the line joining their middle points. The discussion of this subject was concluded in another memoir, read to the Academy on the 8th and 15th of January, 1821.

This year, 1821, was signalized by the commencement of the labors of Faraday in electro-magnetism. This philosopher, who has since attained such well-merited celebrity, realized a suggestion which originated with Dr. Wollaston. A magnet being placed in a vertical position, a wire was so suspended that, while the electric current was passing through it, it was capable of moving round the axis of the magnet so as to describe a conical or cylindrical surface. While the current was maintained, the wire took spontaneously this motion; and when the direction of the current along it was reversed, it reversed its motion, and turned round the magnet the contrary way. Reversing these conditions, and instead of fixing the magnet and leaving the wire free, he fixed the wire, and so adjusted the magnet that it was at liberty to revolve round the wire as an axis. When the current was transmitted through the wire, the magnet spontaneously revolved round it; and when the direction of the current through the wire was changed, the motion of the magnet was reversed.

Faraday attempted, without success, to cause a magnet to revolve on its own axis; but, the memoir containing the account of his experiments being published in France, Ampère succeeded in producing rapid rotatory motion of magnets on their own axes, and showed that this and the two former results of Faraday's experiments followed as necessary consequences of his own mathematical principles. He also showed that the same effects could be produced

with helical currents, thus affording a further corroboration of his theory of magnetic action.

Immediately after the publication of these experiments of Faraday, Davy thought that the effect of the magnet on the current might be obtained in a more simple state by transmitting the current through a fluid conductor, and exposing the conductor to the action of a strong magnet. With this view, two copper wires, about a sixth of an inch in diameter, coated with sealing-wax, and flattened and polished at the ends, were cemented into two holes three inches apart in the bottom of a glass dish, so that the direction of the wires was perpendicular to the dish. The coating of sealing-wax rendered the wires non-conductors, except at their flattened and polished ends, which were not coated. Mercury was poured into the dish so as to cover the ends of the wires to the depth of the tenth or twelfth of an inch. The parts of the wires proceeding from the bottom of the dish were now put in connexion with a powerful Voltaic battery, the positive current flowing into the mercury at one wire, and passing from it at the other. The moment the current commenced, the mercury over each wire was thrown into a state of violent agitation. Its surface was raised into the form of two small cones, one over each wire; waves flowed off in all direction from these cones. On holding the pole of a powerful bar magnet some inches above one of the cones, its vertex was lowered; and according as the magnet descended toward the mercury the subsidence of the cone continued, and the propagation of waves around it ceased, until at length the surface of the mercury became perfectly level, and a slow revolving motion of the mercury round the pole of the magnet began to be manifested. As the magnet was brought still closer to the mercury, this gyration of the fluid became more rapid, and the centre round which the gyration took place (which was directly over the end of the wire) became depressed. The rapidity of the rotation of the mercury, and the depression of the centre of the vortex, continued to increase as the magnet was brought nearer to the mercury, until no more mercury remained over the end of the wire than was barely sufficient to cover it. This rotation took place with either pole of the magnet, and over either wire, changing its direction when either the pole of the magnet or the direction of the current was changed. It is evident that these phenomena are in accordance with, and referable to, the same general law as those previously discovered by Faraday. The same effects were observed when fused tin was substituted for mercury, and when steel wires were used to conduct the current. The current was also conducted to the dish by tubes filled with mercury, with like results.*

In order to determine whether the matter forming the conductor along which the electric current passed had any influence on the electro-magnetic phenomena which at this time engaged the attention of philosophers, Davy placed two pieces of charcoal in connexion with the wires of a powerful Voltaic battery, and, by presenting their points toward each other, at a distance varying from one to four inches, according to the density of the air in which the experiment was made, he obtained a column of electric fluid formed by the current passing through the space between the charcoal points. This current was not transmitted, as usual, along any conductor, but merely passed through the air between the points; and its presence was rendered manifest by the light evolved. When a powerful magnet was presented to this column, with its pole at a very acute angle to it, the column was attracted or repelled with a rotatory motion, or made to revolve by placing the poles in different positions, in the same manner as metallic wire conducting the current would have been. The electric column was more easily affected by the magnet, and its motion

* Phil. Trans., 1823; also Davy's works, vol. vi., p. 258.

was more rapid when it passed through dense than through rarefied air; and, in this case, the conducting medium, or chain of aeriform particles, was much shorter.*

While these investigations were proceeding in France and England, the discoveries to which they led conducted a German philosopher to the invention of an instrument of physical inquiry of surpassing beauty and utility, and equalled in importance by none which had appeared since the balance of torsion.

The *multiplier*, or, as it has been called in England, the *galvanometer*, invented by Schweiger, is an instrument by which the presence of an electric current is detected, and its intensity measured. It is based upon the fact, that a wire through which a current passes will have a tendency to turn a magnetic needle at right angles to it. By this beautiful instrument the most feeble currents may be made manifest, and their intensities compared. It is various in its construction, according to the nature and power of the electric currents intended to be observed, but generally consists of a rectangular frame of wood, round two parallel sides of which a copper wire, lapped with silk, is rolled, so that the coils of wire shall be close beside each other, and parallel in their general direction to the other two sides of the frame. Within the frame, and between the two surfaces formed by the coils of wire, is suspended a magnetic needle. If the frame be so placed that the needle, when at rest, shall be parallel to the coils of wire, these coils will be parallel to the magnetic meridian. Matters being thus disposed, let the extremities of the wire be put in connexion with the poles of a Voltaic pile. The current passing through the wire will act upon the needle, and each coil of the wire will affect it as a separate current, so that the total effect will be in proportion to the number of coils. If the current in the lower coils moved in the same direction as the upper, it would have a contrary effect on the needle; but, by the manner in which the wire is carried round the frame, the systems of inferior currents are contrary in their direction to the superior currents, and they have, consequently, the same effect on the needle. If the effect of the current thus multiplied be sufficient, the effects of the earth's magnetism will be overcome, and the needle will be turned at right angles to the wires, and, consequently, will take the direction of magnetic east and west; but if the force of the current be insufficient for this, the needle will be deflected at some definite angle with the magnetic meridian, the magnitude of which angle will supply the means of estimating the force of the current.

It is evident that the sensibility of this instrument will be augmented in proportion as the magnetism of the needle is enfeebled, and the number of coils of wire augmented.

The direction of the current is indicated by the direction in which the deflection of the needle takes place. If the north pole of the needle be deflected toward the east when the current passes in one direction through the wire of the multiplier, it will be equally deflected toward the west when the same current is reversed.

When Ampère had demonstrated the reciprocal action of electric currents on each other, and on magnets, he showed that the terrestrial globe exerted an influence on magnets freely suspended, and on electric currents transmitted through wires so supported as to be capable of obeying any forces exerted upon them, identical in all respects with the influence which a sphere would exert round which a wire coiled so that its coils shall nearly coincide with the parallels of latitude, through which wire an electric current is transmitted, running continually from east to west, or contrary to the diurnal motion of the earth;

* Phil. Trans., 1821; Davy's works, vol. vi., p. 232.

or, since the wire in such case is merely necessary to conduct the electricity, the phenomena of terrestrial magnetism only require the admission that a series of electric currents continually circulate round the globe, according to lines which intersect the magnetic meridians perpendicularly.

To present an experimental verification of this theory, M. Ampère constructed a plane geometrical figure—a circle, for example—of wire, and suspended it in such a manner that, while the current circulated upon it, the figure was capable of moving on a vertical axis through its centre of gravity. It was observed to throw its plane into a position at right angles to the magnetic meridian. When the current was reversed, it turned round through one hundred and eighty degrees, and reversed its plane. When a helix was suspended on its centre of gravity, and a current was transmitted through the wire, it exhibited all the properties of a magnet; when suspended on a vertical axis, it assumed the direction of the magnetic meridian; and when suspended on a horizontal axis at right angles to the magnetic meridian, it threw itself parallel to the dipping needle.

The hypothesis of Davy, that the nucleus of the globe consisted of the metallic bases of the alkalis and earths, and that its surface was oxydated, supplied Ampère with strong grounds of probability in support of these theoretical ideas of terrestrial magnetism. It was easy to imagine that, at the surface of contact of the metallic nucleus and the surrounding shell of oxydated matter, there were constant chemical actions in progress, which might produce a series of electric currents at some distance below the surface of the earth, and that these currents, acting through the shell of oxides, would produce the phenomena of terrestrial magnetism.

In the same year, M. de la Rive, of Geneva, published a memoir, in which he showed that when a current is transmitted through a closed circuit of a rectangular form, for example, it affected only the sides which have a vertical position. He established, as a general law, that a vertical current, capable of revolving round a fixed vertical line as an axis, will place itself so that the plane passing through its own direction, and the axis round which it revolves, shall be at right angles to the magnetic meridian, the side on which the current descends being on the east of the axis, and the side on which it ascends being on the west.

He also showed that a horizontal current, though not susceptible of being influenced by the magnetism of the earth, is not therefore free from all action; on the contrary, he proved that when it is free to move parallel to itself, it will move in this manner in the one direction or the other, according to its own direction; and that this motion will equally ensue in all positions in which it may be placed, whether it be directed north and south, east and west, or in any intermediate azimuth.

These laws, proved experimentally by M. de la Rive, were immediately shown by M. Ampère to be direct consequences of his theoretical principles.

In the year 1827, M. Savary directed his labors to follow out the researches on the power of the Voltaic current to impart magnetism to iron, which had been demonstrated by the experiments of Davy and Arago. M. Savary discharged a Leyden jar through a metallic wire, needles placed near which were found to be magnetized, and the strength of the magnetism imparted to them was observed to vary with their distance from the wire. Being placed at various distances from it, the magnetizing power of the current was not found either continually augmented, or continually decreased; but, as the needle receded, it first increased, and then diminished, attaining a maximum at a certain position. He also showed that as the distance varied, not only the intensity of the magnetic force passed thus successively through maxima and minima,

but the polarity was reversed, taking alternately one direction or the other. These alternations of intensity and polarity appeared to be determined in a great measure by the weight, diameter, and conducting power of the wire, and the strength of the electric discharge.

One of the most novel and unexpected circumstances attending the experiments of M. Savary, was the manner in which he showed that the magnetizing influence of the current was modified by transmitting it through other metals. When the needle to be magnetized was enveloped in metallic leaf, the magnetism it received was augmented. By gradually increasing the thickness of its metallic coating, the force of the magnetism it received increased by degrees till it attained a maximum, after which it diminished; and, by further augmenting the thickness of its coating, it was diminished so as to be equal to the magnetism it would receive without any coating. Copper, tin, gold, silver, and mercury, used as coating, were found to possess this property in different degrees. The force of the electric charge transmitted through the wire was found to have a singular influence on the phenomenon; for, according as this force was increased or diminished, different thicknesses of the same coating were necessary to produce equal effects. These considerations also affected the direction of the polarity.

These facts appeared to M. Savary to be scarcely compatible with any hypothesis which requires the admission or the translation of electric matter by the current; and he considered that they indicated rather that the current proceeds from a system of undulations propagated along the wire, and transmitted by it laterally to adjacent media.

HERMO-ELECTRICITY.

The fact that a derangement of the equilibrium of temperature was attended with the evolution of electric effects was observed by Volta, and subsequently by Dessaignes. Volta found that a plate of silver, one end of which was more heated than the other, produced Galvanic effects; and Dessaignes observed that convulsions were produced in the frog, when the muscles and nerves were connected by a silver spoon in which lighted charcoal was placed. These isolated observations, however, led to no conclusions affecting the progress of discovery.

Immediately after the discovery of Oersted became known throughout Europe, Professor Seebeck, of Berlin, engaged in a series of researches on the Voltaic effects produced by derangement of temperature; and communicated to the Academy of Sciences of Berlin, during the years 1821 and 1822, the results of his experiments, which were published in the "Transactions" of that body, and form the basis of whatever has since been collected under the title of *thermo-electricity*.

A rod of copper being bent into a semicircle, a bar of antimony was soldered to it, so that the two metals had the form of a stirrup. The temperature of one of the points of junction of the metals was raised, while that of the other was unchanged. An electric current was immediately excited, passing from the copper at the heated point through the antimony. The intensity of the current was augmented by augmenting the difference of temperature of the two points of connexion of the metals, and the direction of the current was reversed when the source of heat was removed from one point of junction to the other. The current was rendered manifest by its power to deflect a magnetic needle.

Seebeck observed similar effects by combining various other metals in pairs; and found that the relative electric state of the metals did not correspond with

that assigned to them in Volta's theory of contact. He also observed that currents were produced by inequality of temperature in bars of a single metal, when they have a crystalline structure; and suggested that the changes of temperature of the metallic nucleus supposed by Davy to be within the external crust of the earth, might produce those currents circulating round the globe to the influence of which Ampère ascribed the magnetism of the globe.

In the year 1823, these inquiries were prosecuted by the chevalier Yelin, and MM. Marsh and Cumming.* The first investigated the influence of the nature and form of homogeneous metals on the direction and intensity of the electric current. The two latter philosophers produced the revolution of thermo-electric currents round magnets. Soon afterward, MM. Oersted and Fourier communicated to the Academy of Sciences a series of experiments on currents obtained by thermo-electric piles, made by combining bars of antimony and bismuth in a series. The alternate points of junction were heated, and the current was manifested by the deflection of a magnetic needle. This deflection, though considerable, was not observed to increase in proportion to the number of thermo-electric elements constituting the pile. They attempted, without success, to effect chemical decompositions by the current thus obtained. This has, however, been since effected by Becquérel, by exposing to the action of the thermo-electric current solutions easily decomposable. M. Bottot, of Turin has also succeeded in decomposing water, and various solutions, by the thermo-electric current obtained from a pile formed of a series of wires of platinum and iron.

The result of these and subsequent investigations of Seebeck, Becquérel, and others, has led to the establishment of the following series of metals possessing thermo-electric excitability, in the order in which they stand:—

- | | | |
|--------------|------------|---------------|
| 1. Bismuth. | 5. Tin. | 9. Zinc. |
| 2. Platinum. | 6. Gold. | 10. Iron. |
| 3. Mercury. | 7. Silver. | 11. Antimony. |
| 4. Lead. | 8. Copper. | |

If a thermo-electric couple be formed by any two metals in this series, the positive electricity at the heated point will pass from that metal which holds the higher to that which holds the lower place in the series; consequently, each of the metals in the series is thermo-electrically positive to all above it, and negative to all below it.

The intensity of many thermo-electric currents increases in *proportion* to the temperature up to 40° R., but not after; and at a certain point it falls. It appears, too, from the experiments of M. Becquérel, that each metal has for itself a proper thermo-electric *power*, which is the same for any circuit. He thus expresses it:—

Metals.	Thermo-electric power.
P. Iron.....	5
P. Silver.....	4.07
P. Gold.....	4.052
P. Zinc.....	4.035
P. Copper.....	4
P. Tin.....	3.89
P. Platinum.....	3.68

M. Nobili obtained thermo-electric currents by the contact of a hot and a cold cylinder of porcelain, on each of which was moist cotton. M. Becquérel considers that the water, at two temperatures, is here the exciting cause. The rank of the chief metals, in the thermometric series, beginning with the posi-

* Bibl. Univ., tom. xxiv., xxv., xxvii., and xxix.

tive, is, according to Cumming—bismuth, mercury, platinum, tin, lead, gold, copper, silver, zinc, iron, antimony. When heat is applied to the junction of any pair of these, the current passes from that higher in the list to that lower. Thermo-electric batteries have been made by a combination of pairs in series. Baron Fourier made a hexagon of three pairs of bismuth and antimony: by heating with a lamp or cooling with ice *three* junctions, he obtained increased effects; by heating and cooling the alternate junctions at the same time, he increased the effect. From experiments by Oersted, "it appears that the thermo-electric current produces a prodigious quantity of electricity, but in a state of very feeble intensity, while the Voltaic current has a very great intensity;" so that *short* elements are most advantageous. M. Pouillet found that if the electro-motive power of a constant Voltaic pair were 95, that of a thermo-pair of bismuth and antimony would be 1. Mr. Wheatstone, by his admirable application of Ohm's law, found the proportion 1 : 94·6.

THE THERMOMETER.

Advantages of mercurial Thermometer.—Method of constructing one.—To purify the Mercury.—Formation of the Tube.—To fill the Tube.—Determination of the freezing and boiling Points.—Modes of Graduation.—Alcohol Thermometers.—Difficulty of fixing the boiling Point.—Usefulness of the Thermometer.—History of its Invention.—Methods of comparing Scales of different Thermometers.

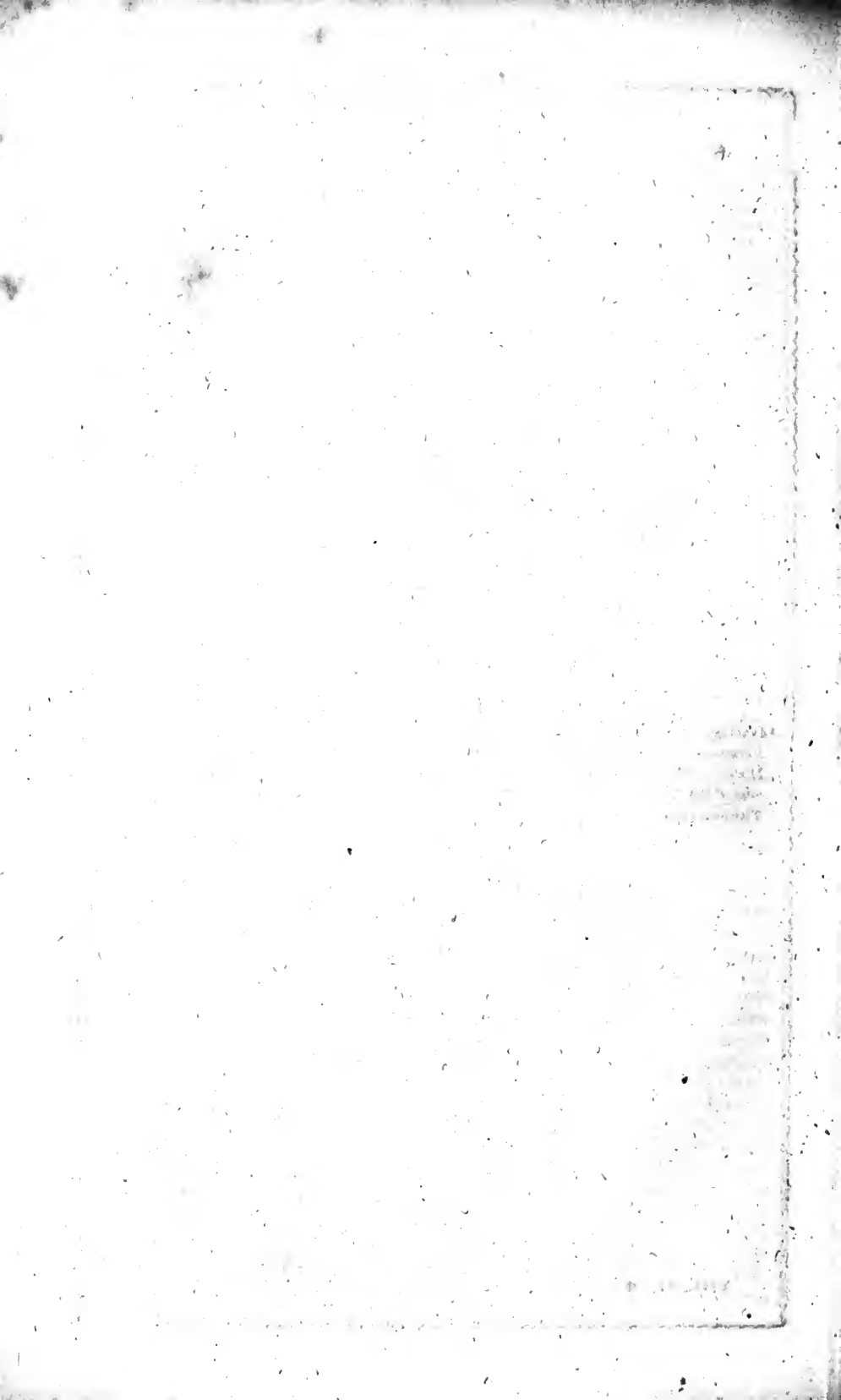

THE THERMOMETER.

HEAT, like all other physical agents, can only be measured by its effects, and these effects are very various. The dilatations and contractions which bodies undergo by change of temperature, so long as these bodies suffer no change in their physical state from solid to liquid, or from liquid to gas, or *vice versâ*, form the best and most convenient means of measuring the degrees of temperature. This property has, therefore, been taken as a principle for the construction of instruments for measuring heat, which have been called *thermometers* and *pyrometers*; the former being applied to the measure of more moderate temperatures, while the latter have been chiefly applied to determine the more fierce degrees of heat.

Bodies in every state being affected with a change of dimension by every change of temperature, all are adapted, more or less, to form measures of temperature. Solids and gases, being more uniform than liquids in their expansions, and having a wider range of temperature without attaining the limits at which they change their physical states, would appear at first view to be the best suited for this purpose. There are other considerations, however, to be attended to, which show that, on the other hand, liquids are best adapted for thermometric indication. The changes of dimension which a solid undergoes by change of temperature are, as has been seen, extremely small, and not easily observed. To appreciate them, it is necessary that their effects should be increased by wheels or levers, or other mechanical means; and such apparatus never fail to introduce error into the result, in proportion to their complexity. Bodies in the aëriform state command, it is true, an unlimited range of temperature, without changing their form; but, on the contrary, their high susceptibility of dilatation and contraction renders them extremely inconvenient in measuring any considerable variations of temperature. The changes of dimension of liquids, while they are greater and more easily observed than those of solids, and therefore require no mechanical contrivance for magnifying them, are, on the other hand, less than those of gases, and present a means exempt from the inconveniences of either of the other methods.

The range of a liquid thermometer must not only be confined between its boiling and freezing points, but within still more narrow limits; for it has been proved that the expansion of liquids, as they approach those temperatures at which they pass into the solid or gaseous state, are subject to irregularities, which render them an uncertain measure of temperature. In the choice of a liquid for a thermometer we must necessarily be directed in some degree by the purpose to which the instrument is applied. An instrument intended to measure very low temperatures may be constructed with a liquid which itself boils at a low temperature; while, on the other hand, such a liquid would be inapplicable in a thermometer designed for measuring higher degrees of heat. Thermometers intended only to measure high temperatures might, on the other hand, be constructed of a liquid, like certain oils, which solidifies at a considerable temperature. For all ordinary purposes, however, that liquid will be the best adapted for thermometers in which, while the freezing and boiling points are separated by a great interval, that interval shall comprise the temperature of the most ordinary objects of domestic or scientific inquiry.

Among liquids, there is one which eminently fulfils these conditions, and which, by reason of its various physical and chemical qualities, is otherwise well adapted for the purposes of the thermometer. This liquid is *mercury*, or *quicksilver*. Mercury boils at a higher temperature than any other liquid, except certain oils; and, on the other hand, it freezes at a lower temperature than all other liquids, except some of the more volatile, such as alcohol, or ether. Thus a mercurial thermometer will have a wider range than any other liquid thermometer. It also is attended with this convenience, that the extent of temperature included between melting ice and boiling water stands at a considerable distance from the limits of its range. Thus it happens that nearly all the temperatures which are necessary to be observed, whether for domestic purposes or scientific inquiry, fall within the range of a mercurial thermometer. It is attended with the further advantage of a higher susceptibility to the action of heat, and its indications are therefore more immediate than those of other liquids. Its expansibility within the extent of temperature of the phenomena most commonly observed are perfectly regular, and proportional to those of solids and gases at the same temperatures. These properties have brought mercurial thermometers into general use in all parts of the world.

To render the thermometer practically useful, it is necessary that its indications should be steady and uniform, and capable of being compared one with another at different times and places. To accomplish this, it is chiefly necessary that the mercury which is used in different thermometers should be perfectly the same. To insure this identity, it is necessary that the mercury used should be pure and free from any admixture of foreign matter. Mercury, however, under ordinary circumstances, is never found in this state. In the mine it is commonly mixed with other substances, which by chemical combination render it solid, and from which it must be disengaged by the process of metallurgy. Even when it is found in the liquid state, it is commonly mixed with silver, lead, or tin—metals with which it combines with great facility. In order to have it perfectly pure, it is necessary first to disengage it from the grosser substances with which it may be mixed. This is easily accomplished by straining it through a piece of chamois leather; the subtle parts of the mercury will pass freely through the pores by merely squeezing the leather between the fingers, and the solid impurities with which it is mixed will be thus intercepted and separated.

It is still necessary, however, to disengage from the mercury other liquids which may be combined with it. This is easily accomplished. Let a boiler be provided, terminated in a tube at the top, which tube is conducted into a re-

ceiver, placed beyond the influence of the fire, so as to be capable of reconverting the vapor of mercury into liquid. Let the impure mercury be placed in this close boiler on a fire. The fact that mercury boils at a lower temperature than any other metal, will cause it to be converted into vapor, while the other metals with which it is mixed continue in the liquid or solid state. The mercury will thus pass over in vapor through the pipe from the top of the boiler into the cooler, where it will be restored to the liquid state, and will be collected free of admixture with other metals. This process, which is called *distillation*, will be more fully described hereafter. If the mercury happen to hold in combination any liquid which boils at a lower temperature than the mercury itself, such a liquid may be dismissed by raising the mercury in the boiler to a temperature below its own boiling point. The liquids combined with it will then pass over in vapor, and will be collected in the cooler separate from the mercury.

Having now obtained pure mercury, unalloyed by admixture with any other substance, the next object is to contrive a means of rendering its dilatations and contractions observable. For this purpose, let a glass tube, of very small bore, be obtained by the ordinary process of glass-blowing; let a spherical bulb be blown at one end of it, of a magnitude very considerable compared with the bore of the tube. As the tube must be of that extremely small bore which is called capillary, the bulb, though not of great magnitude, may still bear a very considerable proportion to it. When the bulb is filled, a very slight change in the volume of the mercury will cause a considerable rise or fall in the tube; because the bulb not considerably altering its dimensions, an increase of volume in the mercury must necessarily find room by forcing the column upward in the tube; and a diminution of volume, for a like reason, will cause the column in the tube to fall. If a portion of the bore of a tube, measuring the eighth of an inch in length, contain the 1000th part of the whole quantity of mercury in the apparatus, then an expansion, amounting to one part in 1000, will cause the column of mercury to rise in the tube the eighth of an inch, a space which is easily observable; and if the bore of the tube be everywhere uniform, every eighth of an inch which the column of mercury rises or falls will correspond to an equal increase in the volume of mercury. The tube and bulb, thus constructed, are attached to a divided scale, by which the rise or fall of the column of mercury in the tube may be accurately measured and observed.

If the scale by which the variations of a mercurial column are measured be divided into equal parts, it is obvious that the bore of the tube should be uniform, for otherwise equal divisions of the scale would not correspond to equal dilatations or contractions of the mercury. If one part of the bore were larger than another, a division at that part would correspond to a greater change in the volume of the mercury than a division at another part where the bore is narrower. As it is a matter of convenience that the divisions on the scale should be equal, it is obviously essential that the bore of the tube should be either accurately or very nearly uniform. There is a very simple and effectual method of ascertaining whether the bore of a tube fulfil this condition. Before the bulb is blown on the tube, let a drop of mercury be introduced into its bore so small as to occupy a space in the bore not exceeding a quarter of an inch, or even less. Let this mercury be gradually moved through the tube from end to end, causing it to rest at different points by holding the tube horizontally, and let the space which it occupies in the tube at different places be measured by some accurate measure. If the mercury occupies the same length of the tube in every part of its bore, it is evident that the bore will be everywhere uniform; but if it occupies a less extent of the bore in one place than in an-

other, then that part where it occupies a less extent must be greater in diameter than other parts, and the bore is consequently not uniform.

For ordinary domestic purposes, and even for most scientific observations, thermometer tubes can be easily obtained of sufficiently uniform bore; but in scientific experiments, where the utmost possible accuracy is sought, it has been thought better not to depend on the uniformity of the bore, but to graduate the scale independently of this condition. Such a graduation may be effected by causing a drop of mercury to move from end to end of the tube, and engraving on the glass with a diamond a number of divisions regulated by the space which the drop of mercury occupied in different parts of the bore. These divisions, whether equal or unequal, would evidently contain the same quantity of mercury, and correspond to equal dilatations or contractions of the fluid.*

Let us suppose, then, that a tube has been obtained of uniform bore, and a bulb blown upon its extremity, and that we are furnished with pure mercury. The next object is to fill the tube with the mercury. If the tube had not been capillary, but had a bore of considerable magnitude, the mercury could have been easily introduced by pouring it through the tube into the bulb; but the bores of tubes commonly used for thermometers are much too small to admit of this process. A method of filling the tube is practised which depends partly on the high expansibility of atmospheric air, and partly on the atmospheric pressure. The bulb of the tube is held for some time over the flame of a spirit-lamp, so that the air contained in it becomes intensely heated. This air, therefore, expands, and becomes highly rarefied, so that the quantity or weight of air contained in the bulb and tube at length bears a very inconsiderable proportion to that which was contained in it at the ordinary temperature of the atmosphere. At the same time, another purpose is answered by this process. A thin film of moisture, attracted from the atmosphere, or in the process of blowing the bulb, is liable to attach itself to the interior surface of the bulb and bore; and if this film were allowed to remain on the tube, it would disturb the indications of the instrument, by becoming mixed with the mercury, and expanding with it in different degrees, so that the apparent expansion would be partly dependant on the expansion of the mercury, and partly on the expansion of the vapor arising from this film of moisture. By the process of heating the bulb, and rarefying the air contained in the tube, this film of moisture is effectually evaporated and expelled, and nothing remains in the tube but a very small quantity of highly-rarefied air. In this state the tube is inverted, placing the bulb upward, and the open end of the tube is plunged in a vessel containing pure mercury. The heat by which the air contained in the bulb was rarefied being now removed, the air begins to resume its former temperature, and all communication with the atmosphere being thus cut off by the open end of the tube being immersed in the mercury, no supply of air is admitted to fill the space caused by the contraction of the air remaining in the tube. Meanwhile, the pressure of the atmosphere acts on the surface of the mercury in the cistern, and presses it up in the tube in the same manner, and from the same cause by which mercury is sustained in the barometer. In this manner the mercury will be found to rise in the thermometer tube, and ultimately to pass into the bulb, the greater part of which will be filled. The small quantity of rarefied air, now contracted into very limited dimensions, will occupy the upper part of the bulb. Let the tube be now once more inverted, placing the open end upward, and let the bulb containing the mercury be again held over the flame of a lamp. After some time, the bubble of air which remains intermixed with the mercury will be forced out of the tube by the expansion caused by the heat. The bulb must still be

* This method of graduation was practised by Gay-Lussac.

held over the lamp till the mercury boils. The vapor of the mercury then rising from its surface will fill the unoccupied part of the bulb and tube, and will altogether expel the atmospheric air from them, so that the whole bulb and tube will be filled with the mercury and its vapor. The instrument must now be once more inverted into the cistern of mercury, and immediately the mercurial vapor in the tube and bulb will be restored to the liquid form by being removed from the lamp which sustained it in the state of vapor. The atmospheric pressure will force mercury into the tube and bulb until both are perfectly filled. The apparatus, therefore, is now filled with pure mercury, free from intermixture with any kind of foreign matter, whether in the solid, liquid, or gaseous form.

Since the indications of the thermometer are made by the rise and fall of the column of mercury in the tube, it follows that, when adapted for use, the instrument must be only partially filled with mercury. It is evident that at the lowest temperature which the instrument is intended to measure, the surface of the mercury ought to be above the point where the tube rises from the bulb; for any contraction of the mercury which would cause the whole of that fluid to enter into the bulb could not be estimated. The whole quantity of mercury in the instrument ought, therefore, to exceed the contents of the bulb when the mercury is at the lowest temperature to which the instrument is intended to be exposed. On the other hand, when the temperature is raised, the expansion of the mercury causing the column in the tube to ascend, it is necessary that the length of the tube should be such that the highest temperature to which it is intended to expose the instrument should be such, that the tube may afford sufficient room for the increase of the column produced by the corresponding expansion. From these observations it will be apparent that the quantity of mercury to be left in the thermometer must depend on the relative magnitudes of the bulb and tube, and on the extremes of temperature which the instrument is intended to measure. Let us suppose that the range of the instrument shall be confined to a few degrees below and above the temperatures of melting ice and boiling water. If too much mercury be left in the tube, on plunging the instrument in boiling water, the mercury would rise to the top of the tube, and by its expansion overflow if it were open, or burst it if closed. If, on the other hand, too little mercury were left in the instrument, on plunging it in melting ice a contraction of the mercury by the cold would cause it to fall into the bulb, and no indication could be obtained of that part of the contraction of the mercury which took place in the bulb. The law by which the dilatation of mercury is regulated, will determine the length which it is necessary the tube of the thermometer should have, provided the diameter of the tube and the contents of the bulb are known. We shall, however, for the present, suppose that the proper quantity of mercury has been introduced into the apparatus, so that the extremes of heat and cold shall not cause either of the effects to which we have just referred.

It is now necessary to close the tube at the top by melting the glass with the blowpipe; but in performing this operation, care must be had to exclude all the air which may remain in the tube above the column of mercury. It is found that if this air were suffered to remain above the mercury in the tube of the thermometer, any accidental agitation of the instrument is liable to cause the bubbles of it to mix with the mercury so as to break the column; and when this happens, it is extremely difficult to disengage it from the mercury, and cause it to ascend to the top of the tube.

In closing the top of the tube, the air is excluded by the following process: The bulb of the thermometer is exposed to heat until the mercury has dilated so as to cause the column to rise very near the extremity of the tube. The

glass at the extremity is then suddenly melted by the blowpipe, so as to close the aperture immediately above the surface of the mercury, leaving no space between them. In this state the sealed instrument is completely filled with mercury to the exclusion of air. The instrument being now removed from the source of heat, the mercury again contracts, leaving the space between the top of the column and the extremity of the tube a vacuum.

So far as the formation of the tube and the preparation of the mercury is concerned, the thermometer is now complete, and by exposure to any variations of temperature, the column of mercury in the tube may be seen to rise and fall; but it is necessary to provide an accurate and easy means of measuring the variations of this column. As we suppose the tube to be uniformly cylindrical, a scale of equal divisions attached to it would accomplish this purpose; but such a scale would merely give the variations of temperature relative to one thermometer, and would not be capable of indications by which observations at different times and places might be compared when taken with instruments similarly constructed. To render the results of different thermometers, thus constructed, capable of being compared one with another, it will be necessary to select some points of temperature, by reference to which all thermometers may be graduated.

Let us suppose that the instrument, as already described, is plunged in a vessel containing melting snow or ice. It will be observed that the mercury in the tube will gradually descend until it arrives at a certain point, at which it will remain stationary, neither ascending nor descending, so long as any portion of the snow or ice remains to be dissolved. When, however, the whole of the ice or snow is liquefied, and the contents of the vessel become pure water, then the thermometer will be observed gradually to rise until it attains that elevation at which it would stand if it were placed in the atmosphere of the apartment in which the experiment takes place. The inference from this experiment is, that so long as the process of liquefaction continues, the temperature remains constant, but after the liquefaction is complete the superior temperature of the apartment causes the water to become hotter; and this increase of temperature continues until the water in the vessel and the air in the apartment acquire the same temperature. Now it is found that the point at which the column of mercury fixes itself, when immersed in the melting ice, is invariable under all circumstances. In whatever part of the world the experiment be tried, and at whatever season, and whatever be the temperature of the apartment, still the column will stand at the same height. This, therefore, furnishes a fixed point of temperature, which can be ascertained in all countries, and under all circumstances. This fixed point of temperature, being marked in the scale attached to the tube, is called *the freezing point*, or *the temperature of melting ice*.

Let a vessel of pure water be now placed on a fire, and let the thermometer be immersed in it. It will be observed that the column of mercury in the tube will gradually rise, according as the water receives heat from the fire, and this ascent will continue until ebullition takes place. It will be then observed that however long a time the fire continues to act on the vessel, the mercury will no longer rise, nor will the intensity of the fire cause any difference in this effect. The mercury will remain steadily at the same point until the whole of the water escapes in steam, and the vessel remains empty. From this experiment we infer that there is a temperature beyond which water is incapable of rising, so long as it remains in the liquid state; and that the whole of the heat communicated to it, after it has attained this point, is carried off by the vapor into which the water is converted. If this experiment be repeated under like circumstances, it is invariably found that in all countries, and at all seasons,

the mercury, when the thermometer is immersed in boiling water, will always stand at the same point. This, then, is another fixed point of temperature, which may be determined at all times, and in all places, and is called the *boiling point*. Let the point at which the column of mercury stands, under these circumstances, be marked on the scale.

The interval between the freezing and boiling points, thus ascertained, is the portion of the tube which corresponds to the expansion of the mercury between these two points of temperature, and this expansion is necessarily always the same; consequently the proportion which the capacity of the tube between these two points bears to the volume of mercury contained in it at the temperature of melting ice must always be the same. If a number of different thermometers, prepared in a manner similar to that already described, be submitted to this process, it will be found that the intervals between the freezing and boiling points in them, severally, will differ in length. The capacities of the tubes, between these points, however, will always bear the same proportions to the capacities of those parts of the instrument below the freezing point, including the bulb. This is a necessary consequence of the uniform expansion of mercury when submitted to the same limits of temperature. It is ascertained that between the boiling and freezing points, the expansion of the mercury amounts to one sixty-third part of its bulk, at the temperature of melting ice; consequently the capacity of the tube between the temperature of melting ice and boiling water, must always be equal to one sixty-third part of the capacity of the bulb, and that part of the tube below the mark indicating the temperature of melting ice. The different lengths of the intervals in different thermometers between the freezing and boiling points will, therefore, arise from the different proportions which the capacity of that part of the tube bears to the capacity of the bulb, and the portion of the tube below the mark indicating the freezing point.

Thermometer thus constructed would, at all times and places, determine the temperatures of all bodies whatsoever, whose temperatures were equal to those particular ones which have been marked on the scale.

Instruments thus constructed would determine with certainty whether the temperature of bodies to which they were exposed were greater or less than those of melting ice or boiling water; but could two philosophers, instituting experiments in different countries corresponding with each other, declare the exact quantity by which the temperature of any body to which the thermometer was exposed exceeded or fell short of those fixed temperatures? To do so, he would naturally inquire by what proportion of the whole interval between the freezing and boiling points the column stood above or below either of these fixed terms. Thus, if he were able to declare that the column stood at a point between the fixed terms at a distance above the freezing point equal to one third of the whole distance between the freezing and boiling points, he would enable another philosopher, in a distant country, to repeat the same experiment, and to compare the results. In order, therefore, perfectly to estimate these proportional distances, the scale attached to the thermometer is further divided, and the interval between the temperatures of melting ice and of boiling water is divided into a number of equal parts previously agreed upon; and that being done, the same divisions are continued above the term of boiling water and below the term of melting ice. The number of divisions into which the interval between the fixed points of temperature is divided, being altogether arbitrary, has been differently determined in different countries, and by the different contrivers of thermometers. The thermometer commonly used in this country, and called *Fahrenheit's thermometer*, has its interval divided into 180 equal parts, called degrees; and these divisions are continued upward and downward.

They are not, however, numerated commencing from either of those fixed points of temperature, but the numeration commences at the thirty-second division below the freezing point, so that the freezing point is 32° and the boiling point 212° . The origin of this circumstance will be stated hereafter. The centigrade thermometer, used in France, has the intervals between the fixed terms divided into 100 equal parts called degrees, the numeration commencing at the freezing point. The thermometer of Reaumur, generally used in other parts of Europe, has the intervals divided into 80° , the numeration commencing likewise at the freezing point. In all thermometers, the degrees below that at which the numeration commences upward are called negative, and are marked by the sign — prefixed to the number. Thus, -10° means 10° below that degree at which the numeration upward commences.

On the slightest consideration it will be perceived that however thermometers may vary in the intervals between the freezing and boiling points, they must, if constructed in the manner just described, agree in their indications of temperature. If two thermometers, having different intervals between these points, be immersed in melting ice, they will both stand at the freezing point. If they then be both transferred into the water at a temperature exactly midway between that and the temperature of boiling water, the mercury, expanding in the same proportion in both, will dilate by exactly half that quantity which it would dilate were it exposed to the temperature of boiling water; consequently it will stand at the middle point exactly between the fixed terms of the scale, and, consequently, upon Fahrenheit's scale, it will indicate the temperature of 122° , being 90° above the freezing point, and 90° below the boiling point. In like manner, if the thermometer were immersed in water having a temperature exceeding the temperature of melting ice by one third of the excess of the temperature of boiling water above that of melting ice, it is evident that the mercury will rise in both through one third of the intervals between the fixed terms, and, consequently, would ascend through a space equal to 60° of Fahrenheit above the freezing point. It would, therefore, stand in both at the temperature of 92° . This reasoning may easily be generalized; and it will be sufficiently apparent that the indications of different thermometers will be the same, whatever be the length of the interval between the fixed terms of their scales.

These arrangements being made, it will be perceived that all thermometers thus constructed, however different they may be in size, in the capacity of their bulbs, or in other circumstances, will always be comparable with each other. Experiments performed in different parts of the world may, therefore, be communicated from place to place, and repeated, with the certainty of an exact correspondence; and all the advantages arising from multiplied experience will thus be obtained.

Various other liquids besides mercury have been employed in the construction of thermometers; but the several conditions for the attainment of accuracy which have been explained in reference to the mercurial thermometers are, for the most part, generally applicable to all liquid thermometers whatever. Alcohol, or spirits of wine, is a liquid not uncommonly used for thermometers. Its inconvenience, however, for ordinary purposes, is, that it boils at a temperature below that of boiling water; and, consequently, it will not admit of a scale so high as this temperature. By adopting the precaution of excluding the air from the tube by the method already explained in the mercurial thermometers, the spirits of wine may, however, be made to indicate much higher temperatures than is commonly supposed. They may be raised to the temperature of boiling water, or even above it. If the air be perfectly excluded from the tube when the temperature is raised above the boiling point of alcohol, the upper

part of the tube will be occupied exclusively by the vapor of alcohol, which will be raised by the heat. The pressure of this will prevent the remaining spirit from boiling; and, the increase of temperature not being limited by ebullition, the liquid will continue to be indefinitely dilated. The indications of such a thermometer, however, at a higher temperature, are not, like those of mercury, equable. The scale, therefore, if intended, to indicate equal variations of temperature, should not be resolved into equal divisions, but should be divided experimentally by comparison with a mercurial thermometer. The cause of this has been already explained in our chapter on the dilatation of liquids. As we approach the boiling point, the rate of their dilatation sensibly increases, so that equal changes of temperature would correspond to increasing divisions on the scale.

It is of the most extreme importance, in the construction of mercurial thermometers, that the fixed terms of melting ice and of boiling water, which are, in fact, the foundation of the accuracy of the instrument, should be determined with great care, and should be rendered independent of all causes which could produce accidental variation in them.

In determining the freezing point, care should be taken not to confound the temperature of melting ice with the temperature at which water begins to freeze. It will be explained hereafter that, under certain circumstances, water may be cooled considerably below the temperature of melting ice before it becomes solid; and, consequently, the temperature at which it freezes or solidifies cannot be considered as fixed.

The temperature, however, at which ice or snow melts is constantly the same, provided the water of which the snow or ice is formed be perfectly pure. If this water, however, hold salts in solution, it will freeze at lower temperatures, and, consequently, it will melt at lower temperatures. Rain-water or pure snow, when melted, will, however, always give the lower term of the thermometric scale, without any liability to error.

The determination of the higher term of the scale is, however, attended with more difficulty, and with more numerous causes of variation. It is, in the first place, necessary that the water should be pure and free from all admixture with foreign substances. Thus, water charged with salts will boil at temperatures different from pure water. It is necessary, therefore, that the water with which the experiment is made should be either rain-water or distilled water.

There is, however, another cause, which more constantly affects the temperature at which water boils. It appears, as may be elsewhere shown, that the pressure exerted on the surface of the water, whether of the atmosphere or from condensed or rarefied air, will affect its boiling temperature. If this temperature be increased, the water will receive a higher temperature before it will boil; and if it be diminished, it will, on the other hand, boil at a lower temperature. Thus, water in an exhausted receiver will boil at a much lower temperature than when exposed to the atmosphere. These circumstances may be more fully detailed in another lecture; but, for the present, it will be sufficient to allude to them, in order to explain why the pressure of the atmosphere must be attended to in determining the boiling point on a thermometric scale. The barometer, from day to day, and from hour to hour, is subject to fluctuation, and a corresponding change takes place in the pressure of the atmosphere; consequently, although this variation, being small, cannot affect the temperature at which water boils to any considerable extent, yet it does affect it so much as to render it an object of important calculation in determining an element such as that now under consideration, upon which the accuracy of all thermometric indications must depend. To determine this fixed temperature, therefore, it will be necessary, either to recur to some phenomena not affected

by the atmospheric pressure, or to select some determinate pressure of the atmosphere, or height of the barometer, at which the fixed temperature must be taken. An alloy of two parts of lead, three of tin, and five of bismuth, was found by Newton to be fused at a fixed temperature nearly equal to that of boiling water. As this fusion is not affected by the atmospheric pressure, it might be taken as the means of determining the boiling point on a thermometer; but it is more convenient to note the temperature of boiling water, and at the same time to observe the height of the barometer. If it be agreed that the boiling point be taken when the barometer stands at a given altitude, as at 30 inches, then, by knowing the law at which the temperature of boiling water varies, with reference to the variation in the pressure of the atmosphere, it will be easy to reduce the boiling temperature under any pressure to that with the pressure agreed upon. The pressure recommended in the directions published by the Royal Society for the construction of thermometers, is that of the atmosphere when the barometer stands at 29.8 inches.

The temperature at which water boils is varied, in some degree, according to the material of the vessels which contain it, and also according to solid substances which may be mixed with it, though they may not be held in solution. If distilled water be boiled in a vessel of glass, the process will be observed to go on irregularly, and with apparent difficulty. When the fire is removed, and the temperature lowered, it may be restored to the state of ebullition by throwing into it some iron filings. Nevertheless, though it thus boils, its temperature is lower than that which it had when boiled in the glass before the iron filings were introduced. In determining the boiling point on the thermometric scale, the water should, therefore, be free from any solid admixture, and should be boiled in a metallic vessel.

In observing these fixed points of temperature, the thermometer, when immersed in melting ice, should be completely submerged, not only as to the bulb, but as to the tube, in order that every part of the mercury should take the same temperature. If the bulb alone were immersed, the mercury in the bulb would have the temperature of the melting ice, while the mercury in the tube would have the temperature of the surrounding air; consequently, the column would stand at a greater altitude than that which it would have were it all at the same temperature. It is possible, by calculation, to allow for this difference; but it is more effectual, and more conducive to accuracy, to immerse the whole thermometer in the fluid.

The accurate determination of the boiling point requires still further precautions.

When water contained in the vessel boils, the strata at different depths have different temperatures; and if the instrument be immersed vertically, the mercury in the bulb will have a higher temperature than the mercury in the tube. It is necessary, therefore, if the thermometer be immersed in the fluid, that it should be placed in a horizontal position, and not immersed to a greater depth than is necessary to cover the bulb and tube. This position, however, is one which renders it extremely difficult to observe with accuracy the height of the column. The fact, which will be proved hereafter, that steam raised from water has the same temperature with the water from which it proceeds, furnishes an easy means of fixing the boiling point. Let the thermometer tube be inserted in the neck of a vessel, so that the bulb shall reach nearly to the surface of the water, and let another orifice be provided through which the steam may escape into the atmosphere. This done, let the water be boiled until the space in the vessel above its surface is completely filled with steam, as will be shown by the rapid escape of the steam from the orifice provided for that purpose. The thermometer, including the tube and bulb, is now surrounded by

an atmosphere of steam raised from the water under a pressure equal to that of the atmosphere. This steam has the true temperature of the boiling water ; and, by drawing the tube upward through the orifice in which it plays, the height of the mercurial column in the thermometer may be marked with the utmost accuracy, and thus the boiling point may be determined.

The variation of the column in the thermometric tube, strictly speaking, arises not from the expansion of the mercury alone, but from the difference between the expansions of the mercury and glass. It is clear that, if a given change of temperature dilated equally the glass of the tube and bulb, and the mercury contained in it, the height of the column would not be varied ; because, in the same proportion as the dimensions of the mercury would be increased, the capacity of the tube and bulb would also be increased. But, in fact, although the tube and bulb undergo an increase of dimension from every change of temperature, that increase is extremely small when compared with the dilatations of the mercury, and consequently, notwithstanding that more room is made for the fluid by the dilatation of the glass, yet still, the room not being nearly sufficient, the mercury rises. Nevertheless, although the variations of the mercurial column are not absolute indications of the dilatation or contraction of the mercury, yet it so happens that, under all the changes of temperature to which a mercurial thermometer can be submitted, the dilatation of glass is in the same proportion as the dilatation of mercury, and consequently the change of volume of the mercury bears a fixed proportion to the change of the capacity of the tube ; and the variation in the height of the column contained in the tube bears also the same proportion to the variations which it would undergo if the glass suffered no expansion or contraction. The apparent dilatation of the mercury, or the difference between the dilatations of the mercury and glass, between the freezing and boiling points, amounts to one sixty-third part of the volume of mercury at the temperature of melting ice ; and the actual dilatation of the mercury between these limits of temperature is somewhat less than this, being $\frac{100}{541\frac{1}{2}}$ parts of the volume of the mercury at the temperature of melting ice.

The fact that the indications of the thermometer are independent of the absolute expansion of the glass which forms it is a matter of great importance, because it shows that the accuracy of thermometers does not depend upon the species of glass of which they are formed. Had it been otherwise, one of the conditions necessary in the construction of a thermometer would be, that the glass should be manufactured of elements precisely alike in all cases. That, however, is by no means necessary. Different kinds of glass undergo different degrees of expansion by change of temperature ; but they will expand proportionally to each other, and proportionally to the expansion of mercury within those limits of temperature to which mercurial thermometers are applied.

It will be perceived, from the reasoning that has been pursued upon this subject, that the indications of all thermometers whatever would necessarily correspond, even though the fluid from which they are formed were different, provided only that the rate of its expansion correspond with that of mercury. A thermometer of spirits of wine, within that part of the scale through which the dilatation of that fluid is uniform, would necessarily correspond with the mercurial thermometer. The difference would only be in the length of the scale, or, in other words, in the distances between the freezing and boiling points. In the case of spirits of wine, however, the rate of dilatation approaching the boiling point of water is not uniform, as has been already stated.

It may possibly be thought that the preceding details respecting the construction and use of thermometers may be elaborately minute, and that an instrument apparently so trifling as a glass bulb blown on the extremity of a tube,

and partially filled with quicksilver, could be described, and have its properties explained, in a much more limited space. It should, however, be remembered that, trifling as this instrument may appear, its uses are, perhaps, more extensive, and certainly not less important, than any other means of experimental investigation by which we are enabled to scrutinise the laws of nature. There is no department of natural science where experiment and observation are the means of knowledge, in which the indications of this instrument are not absolutely indispensable; and this must be apparent, if it be considered how essentially the states of all bodies, whether those contemplated in mechanical science, in chemistry, nay, even in medicine and the natural sciences, are affected both by the external application of heat and its internal development. Without the thermometer, we should possess no means of determining those changes of effects better than the very fallible and inaccurate perceptions of the senses; perceptions which, as it will hereafter appear, depend much more upon circumstances in our ever-changing states of body, than on the states of the bodies around us. In physics, the thermometer is indispensable in almost every experiment. In the laboratory, the chemist can scarcely conduct a process with any degree of philosophical accuracy without an observation of temperatures. In the observatory, the astronomer who is ignorant what effects changes of temperature produce on the indications of the large metallic instruments which he uses—instruments so highly susceptible of dilatation and contraction—would be surrounded with sources of error, of which it would be impossible for him to estimate the amount, or even to detect the existence. Even the aspect of the heavens changes its appearance in obedience to the fluctuating temperatures of air; nor is there a single object in the firmament seen in the same position for two successive hours, and never in the true position which it would have independently of the effects of heat. The vicissitudes of heat and cold, to which the atmosphere is subject, must, therefore, be appreciated before the observer can pronounce on the position of any celestial object; and to this there is no guide but the thermometric tube. The naturalist, in investigating the properties of the various classes of organized bodies, bases many of his generalizations on their temperatures discovered by this instrument. In investigating the qualities of different parts of our planet, the variations of climate corresponding with changes of latitude, the phenomena peculiar to land and sea, the various meteorological facts essential to all knowledge of climate and to all investigation in physical geography, depend on the indications of the thermometer. The measurement of the heights of mountains, of the position of balloons in the atmosphere, are estimated by combined observations on this instrument and the barometer. When these and numerous other considerations are called to mind, it will scarcely be deemed inappropriate, even in a work of a popular nature, to enter into the details which have been here given respecting the construction and use of this instrument. For the same reasons, it may not be uninteresting to the general reader shortly to trace the history of the invention and improvement of thermometers before we conclude this lecture.

Like other inventions of very extensive utility and remote date, that of the thermometer is disputed by many contending claimants; and, like other inventions, the merit is not to be ascribed to one person, but to be distributed among many. The several arrangements which render the instrument useful and accurate as a measure of a degree of temperature were suggested successively, and adopted through a long period of time, and some of the latest of them have not been of very remote date.

The notion of using the expansion of a liquid contained in a bulb and tube of glass, as a means of indicating changes of temperature, is said by some to

have been first suggested by Cornelius Drebbel, a resident at Alkmaer, in Holland. He is said by Boerhaave and Muschenbroek to have invented thermometers about the year 1600. Some Italian writers also assign this honor to Drebbel, but others give the credit of the invention to Galileo; while it is asserted by other Italian authorities, including Borelli and Malpighi, that the merit of the invention is due to Sanctorio, a well-known medical professor at Padua. Sanctorio, indeed, claims the invention himself, and the Florentine academicians, Borelli and Malpighi, are witnesses not likely to be biased in favor of the Patavinian professor.

The thermometer of Sanctorio was formed of a glass bulb and tube, in which the air was first rarefied in a slight degree by the application of heat. The end of the tube was then plunged in a colored liquid, which, when the air contracted by cooling, was forced up into the tube by the atmospheric pressure. The tube was divided into a number of equal parts, called degrees. When the temperature of the medium surrounding the bulb was raised, the air included in it expanded, and the colored liquid was forced downward in the tube. When the temperature surrounding the bulb, on the other hand, was lowered, the air losing some of its elasticity, the liquid was forced higher in the tube by the atmospheric pressure. The number of degrees on the tube through which the colored liquid moved were taken as the indication of the changes of temperature. Thus the thermometer of Sanctorio was, in fact, an air thermometer. Its indications, however, were necessarily affected by the changes in the atmospheric pressure, as well as by change of temperature. At the same temperature, an increase in the atmospheric pressure would cause the column to rise in the tube, and a decrease would cause it to fall. Such an instrument, therefore, when used as an indicator of the variations of temperature, should always be corrected with reference to the changes in the thermometric column. This thermometer has no fixed points of temperature, nor could the indications of one instrument be compared with those of another, nor with itself, after any derangement or change of circumstances.

About fifty years subsequently to this, the Florentine professors constructed thermometers of spirits of wine, and excluded from them the air in the upper part of the tube by the manner already explained with reference to the mercurial thermometer. The tube was divided into one hundred parts, called degrees; but still no fixed points of temperature were adopted.

About the year 1725, Fahrenheit, a thermometer-maker of Amsterdam, first substituted mercury for spirits of wine in thermometers, and by this means considerably reduced their magnitude. The instrument was thus capable of measuring much higher degrees of temperature than thermometers of spirits of wine, because mercury does not boil until it attains a very high temperature. Still, however, thermometers labored under defects arising from the want of fixed points of temperature, the nature of which have been already fully explained. Various attempts were made to insure the correspondence of the scale of different thermometers employed in different parts of the world, but as yet no effectual method was suggested.

Late in the seventeenth century Dr. Hook discovered the fact, that water during its conversion into ice, and ice during its conversion into water, maintained a fixed temperature; and also that water, during the process of boiling under the same circumstances, retains the same temperature. These two temperatures, depending upon fixed phenomena not affected by change of time or place, furnished convenient standards by which the fixed points upon thermometers might be determined; and as such they were first recommended and adopted by Newton. As the process of fusion and evaporation of all bodies are attended with the same peculiar effects as those of water, their temperatures

during these states of transition might with equal convenience be taken as the standards for the fixed points of thermometers ; but water, being a substance always attainable and easily reduced to a pure state, has been selected by common consent, in preference to other bodies.

The same unanimity has not prevailed respecting the division of the scale. It would have been a matter of great convenience, had all nations agreed to divide the interval between the boiling and freezing points of thermometers into the same number of equal parts ; but such a convention was scarcely to be expected. When Fahrenheit adopted the fixed points suggested by Newton, it was supposed that the greatest degree of cold which was attainable was that of a mixture of snow and common salt, or snow and sal ammoniac. A thermometer, when plunged in such a mixture, was observed to fall considerably below the point at which it stood in melting ice, and at which temperature Fahrenheit determined to commence his scale of numeration upward. The interval between this and the temperature of melting ice is divided into 32 equal parts or degrees ; so that upon this scale the temperature produced by mixing snow and common salt is 0° , while the temperature of melting ice is 32° . He continued these equal divisions upward, and found that when the thermometer was immersed in the steam of boiling water, the barometer standing at about 30 inches, the mercury in the thermometer stood at 212° . Thus the interval between the freezing and boiling points was 180° . Temperatures have since been experienced much lower than that obtained by the mixture of snow and common salt, and hence it has been necessary to continue the scale below the 0° of Fahrenheit. Degrees below this point are called negative degrees, as already explained.

The scale as adopted by Fahrenheit has continued in general use in this country to the present day ; and in all English works on science, as well as in the arts, manufactures, and medical practice, the thermometer used is Fahrenheit's thermometer, and the freezing and boiling points are 32° and 212° . The thermometer generally used in France before the revolution, and still used in many parts of Europe, was constructed by Reaumur early in the 18th century. The liquid used by him was spirit of wine ; but, subsequently, mercury was substituted for this by De Luc. The fixed points on this instrument were likewise the freezing and boiling points of water, the scale proceeding upward. The interval between the fixed points was divided into 80 equal parts, called degrees. Thus, the freezing point of water was 0° , and its boiling point 80° . The degrees in this thermometer were longer than those in Fahrenheit, in the proportion of $2\frac{1}{4}$ to 1. To convert a temperature indicated upon Reaumur into the corresponding temperature upon Fahrenheit, it would, therefore, be necessary to multiply the degrees upon Reaumur by $2\frac{1}{4}$, and to add to the product 32° , to allow for the distance of the points at which the scale commences. On the other hand, to reduce Fahrenheit's degree to Reaumur, it would be necessary to subtract 32, and to diminish the remainder in the proportion of $2\frac{1}{4}$ to 1.

About the middle of the eighteenth century, Celsius, a Swedish astronomer, constructed thermometers, in which he commenced the scale, like Reaumur, at the freezing point of water, and divided the interval between the freezing and boiling points into 100° . This thermometer was adopted, after the revolution, in France, under the name of the *centigrade thermometer*. It harmonized with the uniform decimal system of weights and measures, adopted in that country, and has been since that time in general use there. 100° of the centigrade are equal in length to 180° of Fahrenheit. To convert the temperature on the centigrade into the corresponding temperature on Fahrenheit, it would then be necessary, first, to increase the number of degrees in the proportion of 100 to

180, or, what is the same, 5 to 9, and to add to the result 32° , to allow for the difference between the points at which the scale commences. To convert a temperature on Fahrenheit into the corresponding temperature on the centigrade thermometer, it would be necessary to subtract 32° , and to diminish the remainder in the proportion of 9 to 5.

Thermometers are sometimes constructed for scientific purposes, to which all the three scales are annexed. The reduction, however, of equivalent temperatures, one to the other, is a measure of easy arithmetical calculation.

Like all thermometers whose indications depend upon the dilatation or contraction of a liquid, the range of the mercurial thermometer is limited to the points at which mercury freezes and boils. These points, however, as has been already said, include between them a range of very great extent, throughout, nearly the whole of which the indications of the thermometer are uniform. The freezing point of mercury is placed at about -39° of Fahrenheit, or 72° below the freezing point.

Mercury boils at 660° . Thus the range of the thermometer includes about 700° of Fahrenheit. The dilatations of the mercury, as it approaches its boiling point, go on at a slowly-increasing rate; but this increase is compensated for by the expansion of the glass in which the mercury is contained, in such a manner that the apparent dilatation shown by the actual ascent of the column in the tube is really uniform, and the same which would take place if the glass did not expand at all, and the dilatation of the mercury were absolutely uniform. A thermometer intended to measure temperatures below the freezing point of mercury may be constructed of spirits of wine or alcohol. No attainable degree of cold has ever yet reduced this liquid to the solid state, and a thermometer filled with it may be graduated, by comparison with a mercurial thermometer, above the freezing point of mercury; and its indications below the freezing point will thus be rendered capable of comparison with the indications of a mercurial thermometer.

Thermometers whose indications depend on the dilatation of air are rarely used, except for peculiar purposes in which minute variations of temperature only are required to be obtained.

Since mercury boils at a higher temperature than any known liquid, it follows that no liquid thermometer can indicate higher temperatures than that of 660° Fahrenheit. To determine temperatures above this, the dilatation of solids has generally been used; and instruments founded upon this principle are commonly called *pyrometers*. The changes of temperature are indicated by the difference of the expansions of two metals. Such an instrument would indicate all temperatures below that at which the more fusible metal melts.

In the use of the thermometer, and in the inferences drawn from its indications, care should be taken not to assume that the quantity of caloric introduced into the bodies is represented by the degrees of the thermometer. We shall hereafter show that caloric may be introduced into a body without affecting the thermometer at all, and also that different quantities of caloric introduced into different bodies affect the thermometer equally. "Degrees of temperature" are, therefore, to be carefully distinguished from the "quantity of heat;" and the thermometer must be understood as a measure of temperature, and not as a measure of heat. When two bodies are said to undergo the same increase of temperature, it is not meant that these two bodies receive the same increase of heat, but merely that they undergo such a change, with respect to heat, that they are capable of causing a thermometer exposed to them to undergo the same degree of expansion. Again, if a thermometer be immersed in melting ice, and observed to stand at the temperature of 32° , and the same thermome-

ter be surrounded by the steam of boiling water, and be observed to stand at 212° , we declare that the temperature of boiling water exceeds the temperature of melting ice by 180° ; the meaning of which is, that the state, with respect to heat, of boiling water compared with melting ice, is such as to cause a quantity of mercury transferred from the one to the other to increase its dimensions by about one sixty-third part of its whole bulk at the lower temperature.

ATMOSPHERIC ELECTRICITY.

On the Electricity of the Atmosphere in clear Weather.—Connexion between Electricity and Meteorology.—*Apparatus for observing the Electricity of the Atmosphere.*—Insulated elevated Rod.—Portable Apparatus made of a fishing Rod.—Saussure's Electroscope and his Mode of estimating the Value of the Divergences.—Occasional Use of the Galvanometer.—*The ordinary State of the Atmosphere.*—Volta's Theory of the Origin of Atmospheric Electricity.—Inadequacy of the Theory of Chemical Origin.—The Author's Suggestion of the probable Influence of Friction.—*Diurnal Variation of the Electricity.*—Periodical hourly Variation.—Representation of the Rate of Variation.—Maxima and Minima at a given Parallel.—Schübler's Observations.—*Annual Variation of the Electricity.*—Variation of the daily Maxima and Minima.—Arago's Repetition of Schübler's Observations.—*Local Variations of the Electricity.*—Influence of particular Localities, Buildings, &c.—No satisfactory Explanation yet given of the Variations.—Correspondence between Electric and Magnetic Variations.—Becquerel's Explanation of the Phenomena of Variation.—*Distribution of Electricity of the Air.*—Negative State of the Earth.—Character of the lower Stratum of Air.—Increase of Electric Charge in the higher Strata of Air.—Decrease in the lower Strata.—Comparative Electric Character of different Strata.—Formulae for the comparative Electricity of two Strata.—*Electricity of the Air in clouded Weather.*—Preliminary.—Schübler's Observations.—Table of Observations explained



ATMOSPHERIC ELECTRICITY.

AMONG the innumerable relations of the electric fluid with the phenomena of nature, there are none which present so many circumstances of general interest as its connexion with the various states and appearances of the atmosphere. Indeed, it were difficult to name any atmospheric change which is not directly or indirectly connected with electric agency. It is true that these phenomena, fugitive and transitory as most of them are, have not been, in every case, traced to their causes; that the relation of many of them to the agency of electricity is rendered probable from general appearances, rather than distinctly and satisfactorily demonstrated; that some of them, which are evidently of electric origin, nevertheless have not been explained by or reduced to any of the known laws which govern that physical agent; still, there is much that falls under the general principles of electrical science; and those phenomena which remain without any, or without satisfactory explanation, require to be stated, that those who pursue this part of physical science, with the view to extend its limits, may be guided to the proper subjects of observation and investigation.

We shall first, then, state generally the apparatus used for observing the electric state of the air, and shall next proceed to explain the results at which those philosophers have arrived whose attention has been directed to atmospheric electricity.

APPARATUS FOR OBSERVING THE ELECTRICITY OF THE ATMOSPHERE.

To construct a stationary apparatus for observing the electric state of the air, let a rod of iron, from twenty to twenty-five feet in length, be erected at the top of the building in which the observatory is placed, and let it be carefully insulated at the points where it meets the roof and other parts of the building. The lower parts of this rod should be in metallic communication with an electroscope placed in the observatory, by means of a chain or bar capable of

being removed at pleasure. A moveable communication should also be provided between the pointed rod and a metallic bar continued to the ground, so that in cases of thunder-storms, or at any other time when the electricity of the air is so strong as to be attended with danger, it may be allowed to escape to the earth by putting the pointed rod in communication with this conductor. If it be desired to observe the electric state of the air when it is strongly charged, the bar connecting the pointed rod with the conductor may be brought so near the latter as to allow the chief part of the electricity to pass through it to the ground; and, at the same time, the connexion of the electroscope with the pointed rod being preserved, a sufficient quantity of electricity will affect it to indicate the species of electricity with which the air is charged.

For occasional observations a convenient and portable apparatus may be formed with a common fishing-rod, which is divided into several pieces capable of being united at pleasure, so as to form a single rod of considerable length. To the extreme piece of this let a rod of glass, terminated by a fine metallic point, be attached; a metallic wire attached to this point is carried to the electroscope, which will thus receive the electricity collected by the point of the rod. This rod may be elevated in any situation in which it is desired to examine the electric state of the air.

Various forms of electroscopes are used to observe atmospheric electricity. Saussure used two fine metallic wires, each having a small pith-ball suspended at its lower extremity, and having its upper end attached to a rod of metal inserted in the top of a square tube of glass about two inches in the side. The two balls were suspended in contact in the interior of this tube, and the extent of their divergence was measured by a scale drawn on one of the sides of the tube. To the upper extremity of the rod supporting the wires was screwed a pointed conductor, composed of three parts fitting into each other, each measuring from three to four inches in length.

This conductor, being elevated in the air, collected the electricity. To preserve the electroscope from the effect of the weather a brass cup was provided, which was screwed upon the rod supporting the wires at the foot of the conductor.

This apparatus is usually affected sensibly by the electricity of the air, when raised in the atmosphere to the height of ten or twelve feet above the head of the observer. In order to compare numerically the intensity of the electricity which produces different degrees of divergence of the wires, Saussure adopted the following ingenious method. Having constructed two electroscopes as similar to each other in all respects as possible, and removed the conductors from them, he electrified one of them so as to produce a certain divergence, six lines, for example, of the balls. He then brought into contact the metal rods of the two instruments, so as to share equally between them the electricity with which the first was charged. The divergence was now reduced to four lines. Hence electric charges in the ratio of 1 to 2, correspond to divergences of the balls in the ratio of 2 to 3.

The second electrometer being discharged, and again put in communication with the first, the remaining charge of the latter was again shared equally between them, so that the first remained charged with only a fourth of its original electricity. The separation of the balls was now found to be 2.8 lines. By continuing this process, a table was constructed by which the ratio of the intensities of the electricity could always be approximatively inferred from the extent to which the balls were separated. It is evident that such a table will not be the same for all electroscopes. Each observer must, therefore, construct, from immediate observation, a table suitable to the individual electroscope which he uses.

Volta used, for a like purpose, an apparatus similar to that of Saussure, but adopted the straw electroscope. He assumed that the angles of divergence of the blades of straw within the limits of 26° are sensibly proportional to the intensities of the electric charges, and that, provided the blades exceed an inch or two in length, the results are not affected by any small variation of length. It is safer, however, to construct a table according to the method explained above, whatever be the form of the electroscope.

To augment the sensibility of the instrument, Volta also fixed a lamp to the point of the conductor, and interposed a condenser between the conductor and the electroscope. Both of these expedients, however, render the indications of the instrument uncertain. In the process of combustion electricity will be liberated, the effects of which will combine with those of the atmosphere in affecting the electroscope; and unless the plates of the condenser be formed of gold or platinum, or be coated with these metals, their oxydation, by the deposition of moisture upon them, would produce disturbing effects.

In some cases the *multiplier*, or *galvanometer*, is advantageously applicable for meteorological purposes. Since, however, the electric current transmitted through it in such applications has greater intensity than that which is produced in Voltaic arrangements, greater precautions must be taken to insulate the wire. For this purpose the wire, wrapped in the usual manner with silk, may be immersed in a concentrated solution of gum lac in alcohol. When well coated with this varnish, the electricity will not escape from one convolution to another.

In the application of the multiplier to detect the electricity of the air, one extremity of the wire is attached to the foot of a pointed insulated conductor, elevated to the proper height in the atmosphere, and the other extremity communicates with the ground. The air and the earth being in opposite electrical states, a current will pass through the wire, the intensity of which will be indicated in the usual manner, by the deviation of the magnetic needle.

OF THE ORDINARY STATE OF THE ATMOSPHERE.

One of the earliest results of the observation of the electrical state of the air was the discovery of the fact that in clear weather, when the natural state of the atmosphere is undisturbed by clouds, *it is always charged with positive electricity, and the surface of the earth is, on the contrary, charged with negative electricity.* Volta explained this fact by stating that in the evaporation of water the natural electricity of the liquid is decomposed, the positive fluid escaping with the vapor, and the negative fluid remaining on the vessel in which the liquor is evaporated; and this process going on upon a large scale in the oceans, seas, and other large collections of water, might charge the atmosphere with free positive electricity. But we have seen from Peltier's experiment, that mere evaporation without *chemical* decomposition is not enough; we have seen, too, from Armstrong's and Faraday's experiments, that mere evaporation without *friction* is not enough; we are hence led to modify our views, and consider how far chemical effects and friction can be included as operating causes in the electrization of the atmosphere.

It is certain that such essential chemical effects as the liberation of particles of water of crystallization from combination with salts, do not exist in the evaporation to which common consent has ascribed the electricity of the atmosphere; and philosophers have felt that the cause here assigned is inadequate to the effect. If they tacitly accept the theory, it is rather for want of a better than from any feeling of conviction. They cannot imagine the con-

necting links between its assumed chemical origin and its ultimate conversion into the lightning flash.

As the friction of watery particles is a discovery only just matured, the idea has not yet occurred of including it in the investigation of atmospheric electricity. Though the present state of our knowledge does not justify us to hazard an answer, yet we are called on to propose the question—Do the watery particles with which the atmosphere is charged acquire positive electricity as they are rubbed by the wind against the earth, and all it sustains, as hills, rocks, trees, &c., in the same manner as the stream of steam and water becomes positive by rubbing against the jet? If so, what connexion may not be traced between the hurricane winds of the tropics and the prevailing lightning-storms with which those regions abound? Does the friction together of two currents of air, charged to different degrees with moisture, develop the two electrical states?

Throwing out these hints, we come to consider the actual conditions presented by the atmosphere. The first fact which presents itself is the extreme irregularity in the distribution of the electricity; and this would necessarily ensue from either theory, for local variation is an essential element in any view which we may be induced to adopt. Each theory includes evaporation, either as producing the electricity, or as providing the rubbing particles; so that, in the sequel, we may safely adopt the current language, without pledging ourselves against conviction to either theory, in the present undecided state of the question.

If the evaporation or other processes by which positive electricity is supplied to the atmosphere were uniform over the surface of the globe, the spherical shell of air by which the globe is enclosed would be uniformly charged with positive electricity, and, being a nonconductor, it would be related to the crust of the globe on which it rests in the same manner as the cake of an electrophorus is related to the metallic disk in contact with it. The positive electricity of the atmosphere will then act by induction on the natural electricities of the superior parts of the earth; and if we suppose them to possess conducting power in the same degree throughout the surface, the positive fluid resulting from the decomposition would be driven downward, while the negative fluid would be drawn toward the surface, and would augment the intensity of the negative fluid already collected there from other causes.

Thus the atmosphere over different parts of the surface of the earth will receive different quantities of electricity, and, since air is a nonconductor, the inequality of the electric state thus produced will continue, except so far as it may be modified by the effects of atmospheric currents.

DIURNAL VARIATION OF THE ELECTRICITY.

The electric state of the air depending, then, on the results of the evaporation of water on the surface, that state may naturally be expected to be subject to periodical changes corresponding in some definite manner to the changes incidental to the process of general evaporation; and, as these latter changes must be related to the influence of the sun on the atmosphere, a series of vicissitudes in the electricity of the air may be looked for, having some correspondence with the rising and setting of the sun and the epochs of noon and midnight. Observation, accordingly, sanctions this anticipation.

If the electricity of the air be examined by proper electroscopic instruments at and immediately after midnight, its intensity will be found to be gradually decreasing, and this decrease will continue till a little before sunrise, when the intensity, becoming stationary for a short time, will afterward begin to increase

at a slow rate. This increase will continue, becoming more rapid for some hours after sunrise, when it will attain a maximum; after which it will again decrease, at first slowly, and afterward more rapidly. This gradual decrease will continue for some time after the sun passes the meridian, when it will cease, the electrical intensity again attaining a minimum. It will then begin to increase, at first slowly, and afterward more rapidly, until it attains another maximum sometime after sunset. It will then begin to decrease, and continue to decrease until midnight.

If the line $M N M$, fig. 1, be imagined to represent the interval of time between midnight and midnight, its middle point, N , representing the intermedi-

Fig. 1.

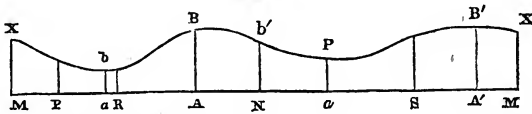

ate noon, and the other points the various hours before and after noon, and if from each point, such as P , a perpendicular be drawn, representing the intensity of the atmospheric electricity at the hour corresponding to P , a curve would be formed, the distances of which from the line $M N M$ would represent the electric state of the atmosphere.

The undulating line $X b B b' B' X$ then represents, in its general character, the diurnal variation of the electricity of the atmosphere when the weather is clear and no extraordinary disturbing influence intervenes to modify the common effects. The points a and a' represent the times of the morning and evening minima, and the perpendiculars $a b$ and $a' b'$ the values of these minima; and the points A and A' represent the morning and evening maxima, and the perpendiculars $A B$ and $A' B'$ the values of these maxima.

If, throughout the same parallel of latitude, no disturbing cause be supposed to be in operation, and the production of electricity in the same position of the sun be everywhere the same, the state of the electricity of the air around the parallel may be represented in a similar way. Let $E N W M$, fig. 2, repre-

Fig. 2.

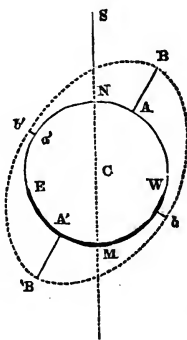

sent the parallel; $E N W$ the enlightened, and $E M W$ the dark part; $C S$ the direction of the meridian passing through the sun.

At the point N the time will be noon, and at M it will be midnight; at E it will be sunset, and at W sunrise. The point a represents the place where the electricity is at the morning minimum, and a' where it is at the evening mini-

mum. In like manner A and A' represent the places where the electricity is at the morning and evening maximum. The curve of electric intensity has, therefore, the form of an oval; the longer axis, B B', being inclined at a small angle to the direction of the sun, and the lesser axis, $a a'$, being at right angles to it. As the position of the sun is gradually changed by its apparent motion from east to west, these axes of the oval follow it, always keeping the same relative position with respect to it in the absence of disturbing causes.

The first philosopher who presented a complete and connected series of observations on the electricity of the air was Schübler, who observed at Stuttgart, and published his observations, taken at various hours, daily, from May, 1811, to June, 1812. As an example of the actual succession of changes exhibited in a single day, the following table of the observations taken on the 11th of May, 1811, will serve:—

Hour.	Electrometer.	Hygrometer.	Thermometer.	Weather.
4 A. M.	5	88	9.3	Perfectly clear. After a short time the heavens became vaporous, and dews began to fall.
5	6½	88	9.5	
6	8	87	10.5	
7	11	86	12.1	
8	12	84	13.5	
9	10	76	15.5	The heavens clear to the horizon; the tint of the firmament a pure blue.
10	8	70	17.0	
12	7	63	20.1	
2 P. M.	6½	61	21.6	
4	5½	60	21.3	
5	5	62	20.9	Vapors begin to be formed, and dew falls.
6	6	65	20.0	
7½	8	72	17.5	
8½	12	83	15.5	Heavens perfectly clear.
9½	8	86	13.0	
10½	7	88	12.1	
12	6½	88	11.0	

ANNUAL VARIATION OF THE ELECTRICITY.

As the diurnal change in the position of the sun, relatively to a given place, produces a periodical variation in the electric state of the air, the change of its declination from month to month may be expected to be followed by some corresponding periodical effect on the mean amount of the maxima and minima values of the electricity. On comparing the mean values from month to month, it is accordingly found that the values of the two daily maxima and minima undergo a progressive decrease from January to July, and a progressive increase from July to January. It is found, also, that during the winter the electricity of the air increases as the thermometer falls.

On comparing the mean values of the maxima and minima throughout the year, it is found that the morning values of each are a little less than the evening values.

The hours at which the electricity attains its maxima and minima values are likewise subject to variation from month to month. The hour of the morning minimum and maximum continually advances toward noon from winter to summer, and undergoes the contrary change in the latter part of the year.

The observations of Schübler indicate that the hour of the evening minimum is invariable. From June, 1811, to June, 1812, it took place at Stuttgart al-

ways at 2 P. M. The hour of the second maximum also gradually approached nearer to noon from summer to winter, and receded from it again from winter to summer.

The series of observations on the diurnal changes of atmospheric electricity, which Schubler made, in 1811-12, were repeated by M. Arago at Paris, in 1830, who obtained similar results. Thus, in the month of March, 1811, Schubler found that the mean time of the morning maximum, was 8 hs. 30 m., and M. Arago found the mean time for the same month, 8 hs. 48 m.

LOCAL VARIATIONS OF THE ELECTRICITY.

In all the preceding observations, the sources which supply positive electricity to the air, are supposed to be uniformly distributed on the surface of the earth. A great variety of local causes, however, interrupt this uniformity. Saussure's observations show that the positive electricity of the air has greatest intensity in the most elevated places, and in those which are best insulated. In the interior of buildings, under trees, in the streets, courts, and other enclosed and sheltered parts of towns, no free electricity is found in the air. In the midst of squares, and other open places in cities, on the quays, but more specially on bridges, it is even more intense than in an open, flat country. In particular localities, such as Geneva, where fogs prevail, which lie low, and are not converted into rain, the positive electricity of the air is most intense. Although the general correspondence between the diurnal and annual variations of the normal electric state of the air indicates, unequivocally, its dependance on the variation of the sun's declination, and the diurnal motion of that body, and the local variations accord with the hypothesis, that evaporation is the chief source of the electricity of the air; still, no complete and satisfactory explanation has yet been proposed for the diurnal and annual electric periods.

Schubler observed that some correspondence may be perceived between the diurnal variation of the magnetic needle, and the diurnal variation of the electricity of the air, and that, if such correspondence be admitted, it would follow that both these phenomena must be ascribed to the same cause. But this correspondence is far from being so exact as to justify even a probable conjecture as to their identity of cause. The maximum variation of the needle *east* takes place at half past eight in the forenoon, from which time till a quarter past one in the afternoon, it turns gradually round toward the west, attaining its maximum western variation at the latter hour. From that time till half-past eight the following morning, it returns gradually eastward. The times of greatest eastward and westward variation correspond nearly to the times of the morning maximum, and evening minimum, but there are no effects exhibited by the needle corresponding to the other maximum and minimum.

Becquerel proposes the following explanation of the diurnal variations of the electricity of the air. Toward the morning the electricity ought to have a feeble intensity, because the humidity of *the evening* and night has restored to the earth a part of the electricity which had been accumulated in the air. When the sun, at its rising, begins to warm the earth, evaporation is promoted and positive electricity supplied to the air. Hence, after sunrise, for some hours, the intensity of the electricity of the air will be augmented. When the sun has attained a certain elevation, and the heat has increased, the air is dried, and transmits with less facility the electric fluid, accumulated in the higher regions of the air; electrometric instruments, therefore, placed near the surface of the earth, will indicate a diminution of electricity, even though the electric fluid should continue to be augmented in the higher parts of the air. As sunset approaches, the air is cooled, becomes humid, and begins to transmit the

electric fluid, accumulated in the higher regions, more abundantly to the earth. The electric intensity would, therefore, increase with the humidity and the dew until two or three hours after sunset. Finally, when the air begins to be exhausted, the electricity again diminishes, and continues to decrease till the next morning. According to the same principles, the annual variation of the electricity is explained. In clear weather, the mean intensity of the electricity of the air will be much less in summer than in winter; for the air in summer, being warm and dry, resists more strongly the transmission of the electric fluid accumulated in the higher regions of the atmosphere, while in winter the air, being more humid, produces a contrary effect.

DISTRIBUTION OF ELECTRICITY OF THE AIR.

Although the negative electricity of the surface of the globe be a consequence of the ascertained fact, that positive electricity is supplied by it to the air, it is necessary, nevertheless, that it be ascertained by immediate observation. This has, accordingly, been done by different observers, at different times, and in different places. Among the more recent observations of this kind, are those of M. Peltier. To ascertain the electricity of the ground, this philosopher used a multiplier, placing one extremity of the platinum wire in a humid part of the soil, and attaching the other end to a pointed metallic conductor, raised in the air. When the air was sufficiently humid to give it a conducting power, a current was established through the wire, by which the needle was sensibly affected, and the deflection of the needle proved that the negative current came from the ground, and the positive from the air.

The negative electricity of the ground, and the positive electricity of the stratum of air contiguous to it, have a continual tendency to re-combine and neutralize each other. From this cause, the lowest stratum of air in clear weather, apart from disturbing causes, is found to be in its natural state. This effect extends to the height of three or four feet from the ground, above which height the positive electricity begins to be perceivable, and increases in its intensity in ascending, according to some definite law, which observation has not yet disclosed.

To ascertain the increase of electricity in the ascending strata of air, Becquerel and Breschet made some experiments on the Great Saint Bernard, according to a method suggested by Saussure. These electricians selected a convenient platform of ground near the monastery, extended upon it a piece of gummed sarcenet, about ten feet long and seven feet wide, upon which they unrolled a silk cord, interlaced with metallic wire, measuring about 250 feet in length. They attached one end of this cord to the hook or rod, which communicated with the straws of an electrometer, by means of a loose knot, in such a manner that when drawn upward, it would be detached from the electrometer without disturbing the instrument. The other extremity of the cord was tied to the tail of an iron arrow, which was projected upward by means of a bow with such force that, attaining a height of more than 250 feet, it detached the lower end of the cord from the electrometer. As the arrow ascended, the electrometer showed a gradually increasing divergence, which soon became so considerable that the straws struck the sides of the case enclosing them. When the cord was detached, the instrument retained the electricity it had received, which, on examination, proved to be positive.

Hence, it appears that from three feet above the ground, to the height of 250 feet, the air is charged with positive electricity, constantly increasing in intensity, at least, in localities like that in which this experiment was made.

Lest it might be supposed that the electricity obtained, was produced by the

friction of the arrow against the air, the experiment was repeated, projecting the arrow horizontally, at the height of three feet from the ground. In this case no effect was produced on the electrometer.

Bequerel made experiments with a like object in clear weather, on the summit of the rock called *Sanadoire*, near the *Mont d'Or*. This summit, separated from the surrounding mountains, is terminated by a platform of the extent of several square yards, at the height of about 4,600 feet above the level of the sea. The electrometer of Saussure was surmounted by a pointed conductor, about twenty inches long. A divergence of the straws, amounting to an eighth of an inch, was produced, when the apparatus was raised about three feet above the head. The divergence was doubled, when a wire, attached to the electrometer, was projected upward by means of a stone, to the height of about thirteen feet, and when projected to greater heights, the divergence continued to augment.

When the apparatus, elevated to a certain height above the head, and showing a certain divergence, was carried down the side of the hill, the divergence gradually diminished, and disappeared altogether, before attaining the foot of the hill.

In the ascent made in a balloon by MM. Gay-Lussac and Biot, the increase of positive electricity in the ascending strata of air was also rendered manifest. These philosophers attached a metallic ball to a wire, about 170 feet long, and suspended it from the car of the balloon, the upper end of the wire being attached to an electrometer. The weather being perfectly clear, the instrument diverged with negative electricity. This result, which was in apparent discordance with the results of observations in general, was, however, easily shown to be consistent with them. The wire, in this case, supplied a conducting communication between two strata of air, one 170 feet above the other. If they were equally charged with the same species of electricity, the electrometer would not have been affected; for the natural electricities of the wire being placed between two equal and contrary decomposing influences, no decomposition would take place, and the wire would remain in its natural state. If, however, the two strata at the ends of the wire were electrified positively, in *different degrees*, a decomposition of the electricities of the wire would ensue, the positive fluid being repelled toward that stratum having the weaker positive charge, and the negative fluid being attracted toward that stratum having the stronger charge. Since, then, the electrometer at the upper extremity of the wire showed negative electricity, it follows that the higher stratum was more intensely positive than the lower.

In a similar experiment made by Saussure, the electrometer was placed at the lower end of the wire, and, in accordance with what has been just explained, the instrument diverged with positive electricity.

The method of explaining the apparently inconsistent results of the experiments of Biot and Saussure, proposed by the former, is imperfect, unless it be admitted that the two strata of air are both *electrified positively*; for if they were both *electrified negatively*, the lower stratum having the stronger charge, the same effects would ensue; or even if they were differently electrified, the upper stratum being positive and the lower negative, the effects would be the same.

Strictly speaking, therefore, the consequence which legitimately follows, from all observations made on the electricity of the air at different heights, by means of a vertical conducting-rod or wire extending from the electroscope to the stratum of which it is desired to ascertain the electric state, is, not that the electricity with which the instrument diverges, is that of the air in which the remote extremity of the conductor is placed, but that if E' be the electricity of

Month.	Electricity of the Air in Times of Rain and Snow.				Electricity in Clouded Weather.			Mean Temp.	Rain, French Inches.
	Maximum Intensity of the Electricity.		Mean Intensity of the Electricity.		Greatest Intensity.	Mean Intensity.			
	Positive.	Negative.	Positive.	Negative.					
June.	+400, on the 1st, in a storm of rain. Hail at 5 o'clock.	-600, on the 30th, in a storm, attended by heavy rain. The electrometer oscillated to +400.	+235, for nine days.	-275, for nine days.	+16	+20, on the 23d, at 6, A. M.	60 $\frac{1}{2}$	5.71	
July.	+600, at 6, P. M., in a violent storm.	-500, on 16th, at 4, P. M. in a violent storm, attended with rain. At the commencement it was +50.	+400, for five days.	-280, for five days.	-	-	62 \circ	1.05	
August.	+500, on 20th, at 7, A. M., in a storm, attended with rain.	-140, on 28th, at 4, P. M., attended with rain.	+290, for seven days.	-80, for seven days.	+25	+30, on 19th, at 7, A. M.	58 \circ	1.66	
Sept.	+30, on 27th, at 7, P. M., in a light rain.	-10, on 25th, at 11, A. M., in a light rain.	+30, for one day.	-10, for two days.	+20.5	+25, on 18th, A. M.	52 \circ	0.70	
October.	+38, on 4th, at 7, P. M., in rain.	-60, on 29th, at 2, P. M., in heavy rain.	+26, for five days.	-31, for six days.	+18	+30, on 28th, at 7, P. M.	52 \circ	1.89	
Nov.	+55, on 11th, at 5, P. M., in heavy rain.	-50, on 12th, at 2, P. M., in rain.	+24, twice in rain, and once in snow.	-25, three times in rain.	+18.1	+28, on 10th, at 2, P. M.	41 \circ	0.84	

Dec.	+60, on 23d, at 6, P. M., in snow and wind.	-400, on 24th, at 2, P. M., in rain and wind.	+32, nine times in snow and once in rain.	-157, three times in rain.	+32.7	+36	35°	1.42
January.	+70, on 13th, at 2, P. M., in heavy snow.	-20, on 21st, at 7, P. M., in snow. It oscil- lated to +20.	+40, seven times in snow.	-17.3, twice in snow, and once in rain.	+34.1	+44, on 30th, at 6, P. M.	27½°	1.06
Feb.	+90, on 16th, at 7, P. M., in snow and rain.	-150, on 16th, at 5, P. M., in rain. It occa- sionally became +.	+41, twice in rain, and once in snow.	-44, eight times in rain and once in snow.	+33.2	+55, on 4th, at 7, P. M.	37½°	1.72
March.	+200, on 5th, at 2, P. M., in snow and hail.	-340, on 22d, at 5, P. M., in heavy rain. It oscillated to +110.	+74, six times in rain, and twice in snow.	-65, eight times in rain, and three times in snow.	+21.0	+21, on 20th, at 9, A. M.	39°	1.61
April.	+50, on 9th, at 2, P. M., in snow.	-80, on 22d, at 8, P. M., in rain.	+40, for four days in snow.	-58, for five days in rain.	+15.5	+17, on 7th, A. M.	40°	1.26
May.	+600, on 16th, at 8 o'- clock, in a storm, attend- ed with rain.	-600, on 29th, at 8, P. M., in a violent storm, with rain.	+186, with rain for nine days.	-179, in rain for six days.	+14.0	+14, on 20th, A. M.	52°	2.14
Mean.	+600 = the greatest mean.	-600. -245.	+117, for seventy- one days.	-101, for sixty-nine days.	+22.5	+55.0	46°	21.06

the stratum in which the electrometer is placed, and E that of the stratum in which the remote end of the conductor is placed, then, when the instrument diverges with positive electricity, $E-E'$, will be positive, and when it diverges with negative electricity, $E-E'$, will be negative. If the species of electricity of either stratum be otherwise known, such an observation will indicate the species of the other stratum; but if not, it will only give a different result.

ELECTRICITY OF THE AIR IN CLOUDED WEATHER.

The electric state of the atmosphere in clear and unclouded weather only has been hitherto explained. We shall now proceed to state the observations which have been made when the heavens are more or less charged with clouds, whether attended or not with rain, snow, hail, or other phenomena of storms.

From the month of June, 1811, to May, 1812, both inclusive, M. Schübler observed the electricity of the atmosphere in clouded weather and in times of rain, hail, and snow. In the table on pp. 158, 159, a synopsis is given of the results of his observations. An examination of the results registered in this table will establish the following conclusions:—

1. That in stormy weather, in rain, hail, or snow, the electricity of the air is much more intense than at other times.
2. That in such weather the electricity is sometimes positive and sometimes negative, and nearly as often the one as the other.
3. That in such weather the electricity often undergoes sudden changes from positive to negative, and *vice versa*.
4. That in clouded weather, unattended by storms, rain, hail, or snow, the free electricity of the air is positive.
5. That the intensity of this electricity is greater in winter than in summer.

EVAPORATION.

Erroneously ascribed to Chemical Combination.—Takes place from the Surface.—Law discovered by Dalton extended to all Liquids.—Limit of Evaporation conjectured by Faraday.—Hygrometers.—Various Phenomena explained by Evaporation.—Leslie's Method of freezing.—Examples in the useful Arts.—Methods of Cooling by Evaporation.—Dangerous Effects of Dampness.—Wollaston's Cryophorus.—Pneumatic Ink-Bottle.—Clouds.—Dew.

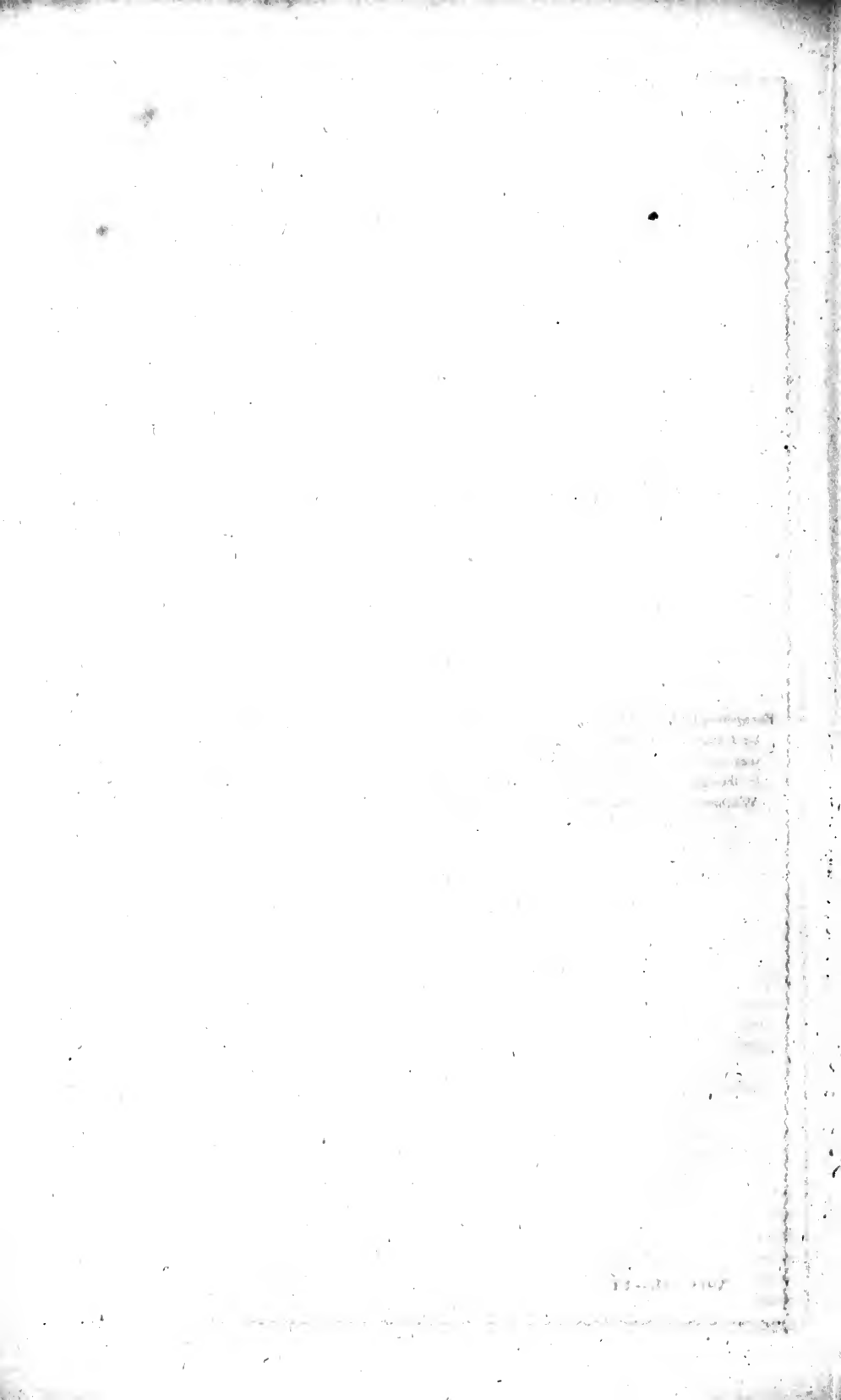

EVAPORATION.

It was long supposed that the vapor produced from the surface of liquids exposed to the atmosphere, was the consequence of an affinity between the particles of air and the particles of the liquid, by virtue of which a combination was formed, and consequently a constant absorption took place by the air, of liquids exposed to it. The properties of vapor, however, which have been discovered by the labors of modern philosophers, and above all, by those of DALTON, have proved the fallacy of this supposition, and have shown that all the phenomena of evaporation may be accounted for without supposing any affinity whatever, or other attraction, to exist between the particles of atmospheric air, and those of liquids.

The explanation of evaporation on the principle of chemical combination of the vapors with air, was first suggested by Halley, and supported by many succeeding philosophers. According to this theory, air was considered as having the same effect on water, as water would have on salt, or any other substance which it might hold in solution. The theory was rendered plausible by the facility which it offered in explaining some of the most obvious phenomena of evaporation, such as the circumstance of its being promoted by winds, and by increase of temperature. Currents of air removing the solvent as fast as it became saturated, brought a fresh portion of it to receive vapor, and so the process was continued and stimulated. Heat, also, was supposed to increase the solvent power of the air on water, in a manner analogous to that by which it was known to increase the solvent power of water on other substances.

Vapor, however, at low temperatures, was considered to possess no elasticity, and the discovery of the falsehood of this supposition was the first step toward removing the hypothesis of Halley; but this theory received its death-blow from the fact that vapor is not only formed in a space where no air is present, but that in that space it possesses the same elasticity, and occupies the same volume, as if the same space were filled with the supposed solvent; nay more, that it is not only produced in such a space, but that it is produced in-

stantaneously; whereas, if the supposed solvent were present, its production would be considerably retarded. Thus it appeared that the solution would proceed with greater facility in the absence of the solvent than in its presence.

It has been already shown, that liquids dismiss vapor, whether the space above their surface be an actual vacuum, or be filled with air or other gas, and that if such space be confined within certain limits, it will be capable of receiving from the liquids a different quantity of vapor, depending solely on the temperature of the liquid, and that the quantity which will saturate a given space will be the same, whether that space be a vacuum, or be occupied by atmospheric air, or other aëriiform bodies. The difference in the phenomena in the two cases will only consist in the *rate* at which the saturating vapor is produced from the liquid. In the case of a vacuum, it is produced almost instantaneously; but if air be present, its production is retarded, and a considerable time may elapse before the space above the liquid is saturated.

All masses of water placed on the surface of the globe, have above them a mass of atmospheric air, which at all times maintains suspended in it a quantity of aqueous vapor, raised by the process of evaporation from the surfaces of this liquid. If the quantity sustained in the atmosphere be such as to saturate the air, then it is obvious that no further evaporation whatever can take place at the surface of the water. This, however, does not usually occur. Most commonly the vapor suspended in the atmosphere is insufficient for its saturation; and in this case evaporation will take place. It is the object of the present lecture to explain the laws which attend this process of evaporation in the open air.

Dalton, to whose labors we are indebted in this, as in every other part of the theory of vapors, investigated this subject, and may be said to have nearly exhausted it. He commenced by determining the circumstances which attend the evaporation of water at high temperatures. In such cases, the tension of the vapor actually suspended in the air would produce an inappreciable effect on the phenomena, because its tension would be inconsiderable, when compared with that of the vapor of water at high temperatures. In this first experiment, therefore, he regarded the atmosphere as perfectly dry, and considered the phenomena to proceed as they would in a receiver subject to the presence and pressure of perfectly dry air. A small vessel, containing boiling water, was suspended from the arm of a balance, and accurately poised. A lamp was placed under it, which maintained it at the boiling point, and its loss of weight in a given time by evaporation was accurately determined. The same experiment was repeated with the same vessel, at various temperatures, from 212° to 138° , and the following results were obtained:—

Temperature in Degrees of Fahrenheit.	Elastic force of Vapor in Inches.	Evaporation per Minute in Grains.
212°	30·00	30
180	15·15	15
164	10·41	10
152	7·81	8·5
144	6·37	6
138	5·44	5

From this table it is apparent that at each temperature between the above limits, the rate of evaporation is proportional to the tension of the vapor. It will easily be conceived, however, that the same law cannot extend to evaporation at low temperatures, because, as the temperature of the evaporating

liquid approaches the temperature of the vapor suspended in the air, the tensions will approach more nearly to equality, and the resistance of the vapor already suspended in the air will speedily begin to produce a sensible effect on the rate of evaporation. In order, therefore, to detect the law by which evaporation took place at lower temperatures, it became necessary first to determine the actual tension of the aqueous vapor suspended in the atmosphere at the time of the experiment. The properties of vapor previously discovered by Dalton, led him to an elegant and simple solution of this problem. The aqueous vapor suspended in the atmosphere, not being in a state of saturation, must be regarded as having received a quantity of heat which dilated it and raised its temperature, according to the laws for the dilatation of the permanent gases after it had passed from the liquid to the vaporous state. Now if all the heat which has been imparted to it after it had passed into the vaporous state be taken from it, it will undergo a diminution of temperature, but will not pass from the vaporous to the liquid form. The smallest abstraction of heat beyond this point will, however, cause a deposition of moisture, and a partial condensation of the vapor. If, therefore, a body at a temperature considerably lower than that of the atmosphere be exposed to the air, it will first by abstracting heat from the vapor in contact with it, lower its temperature until it arrives at that temperature which it had when it passed from the liquid to the vaporous state. If the body be at a lower temperature, then, though it can no longer lower the temperature of the vapor, it will condense it, and the vapor will deposit itself in the form of dew on the sides of the body. If the body be actually or nearly at that temperature at which the vapor passed from the liquid to the aëriform state, then the commencement of the condensation will be just indicated by a slight dulness produced on the surface of the body by the condensation of the smallest possible quantity of vapor. Led by such reasoning, Dalton adopted the following means of determining the temperature at which the vapor suspended in the atmosphere had passed from the liquid to the aëriform state: He poured water, at a temperature below that of the atmosphere, into a thin glass tumbler, and exposed it to the air. If he observed an immediate and rapid deposition of dew upon its surface, he then wiped the vessel dry, and exposed it at a somewhat higher temperature. He thus continued to expose the vessel at increasing temperatures, until he found that temperature at which a deposition of moisture would just take place on its surface, and such that one degree higher in temperature would prevent such a condensation of vapor. This, then, he assumed to be the temperature at which the vapor suspended in the atmosphere had passed from the liquid to the aëriform state, and the elasticity or tension corresponding to this temperature was found from the table of elasticity resulting from his former experiments. Now the vapor actually suspended in the air had a higher temperature than this, and was raised to that temperature by heat communicated to it after it had assumed the vaporous form. The additional tension imparted by this increase of temperature was easily computed by the rules for the dilatation of gases and vapors, by heat. Hence he computed the actual tension of the vapor suspended in the atmosphere.

The water used by Dalton in this experiment was taken from deep wells at Manchester, the temperature of which was from 10° to 15° colder than the atmosphere. This served the purpose when the temperature of the air was not very low, but in winter, when the temperature was near the freezing point, it became necessary to cool the water by means of ice, or a mixture of snow and salt, or other freezing mixtures.

The deposition of condensed vapor with the appearance of dew, on the external surface of a glass vessel containing iced water, is a fact of familiar occur-

rence. A decanter of iced water placed on a table always exhibits this effect ; and in summer, a decanter of fresh spring-water will be observed to have a similar deposition on its surface.

He now exposed to the air a vessel of water at various low temperatures, and noted its rate of evaporation ; using, however, a larger surface, in order to obtain a quicker evaporation than in the former case. Upon examining the rates of evaporation resulting from these experiments, he found that they were accurately proportional to the difference between the tension of vapor which would saturate the atmosphere at the temperature of the water, and the tension of the vapor actually suspended in it.

It thus follows, that the rate of evaporation from the surface of water, in all states of the atmosphere, will be proportional to the tension of vapor which would saturate the air, diminished by the tension of the vapor which is actually contained in the air.

The investigations of Dalton were next extended to other liquids, and, as the portion of the vapors of these which would be suspended in the atmosphere would be altogether insignificant, the problem became somewhat more simple. The atmosphere was regarded as perfectly dry with respect to these liquids ; and it was found that their rates of evaporation were, in conformity with the law already obtained for water in a dry atmosphere, always proportional to the tension of the vapor of the liquid which would saturate an empty space at the proposed temperature.

All the preceding results have been obtained on the supposition that the air above the surface of the evaporating liquid is perfectly calm, so that the same stratum shall always remain in contact with the air, and the successive strata above it shall continue undisturbed.

When this is not the case, the rate of evaporation must needs undergo a corresponding change, and this change is generally one which accelerates it. As the liquid imparts its vapor to the stratum immediately above it, and that vapor passes from stratum to stratum upward, the evaporation will be slower in proportion to the quantity of vapor suspended in its strata ; but, if the air be agitated, and especially if a current of wind pass across the surface of the liquid, then, as fast as the vapor is deposited in the strata, it is carried off, and fresh portions of air, not impregnated with vapor, take their place. The evaporation may, in this case, be as rapid as it would be in perfectly dry air, inasmuch as the air above the liquid is never allowed to accumulate in it any quantity of vapor. It may therefore be assumed, as a general principle, that a draught maintained across the surface, or winds, or any agitation of the air, has a tendency to accelerate the process of evaporation.

In the experiments of Dalton, on the vaporization of boiling water, he found that the rate of vaporization in a space perfectly sheltered from currents was slower than when exposed to a draught produced by open windows and doors, in the proportion of two to three. The evaporation in still air was at the rate of thirty grains of water per minute, and in a draught forty-five grains per minute.

Since the evaporation of different liquids is proportional to the tension of their vapors, it follows that liquids which boil at high temperatures must evaporate very slowly at ordinary temperatures, for the tension of the vapors of such liquids are insensible at all ordinary pressures. Indeed, sulphuric acid, mercury, and other like liquids, which boil at very high temperatures, may be regarded as fixed, or having no evaporation whatever.

The evaporation of bodies whose boiling point is high on the thermometric scale being inappreciable at all moderate temperatures, a question arises, whether the vaporizing principle is subject to any limit whatever. As the diminution

in the rate of evaporation is subject to the law of continuity, or undergoes a slow, gradual, and continued diminution, the determination of its actual limit, if it has one, by experiment or observation must obviously be exceedingly difficult, if, indeed, it be within the bounds of possibility. Such a limit, therefore, if it exist, must rather be sought for by the operation of the reason on facts known, than by the operation of the senses on facts to be observed. A system of reasoning, applied with great ingenuity by Dr. Wollaston to fix the limits of the atmosphere, has been applied by Faraday to show that an actual limit must exist, for a similar reason, to the operation of the evaporating principle. Dr. Wollaston argued that the tendency of the molecules of the atmospheric air to repel each other being known by direct observation to be subject to a continual diminution, in proportion as the distances between the molecules increased, or, in other words, in proportion to the rarefaction of the air, and the same molecules being admitted, in common with all other matter, to be subject to the laws of gravitation, it follows inevitably that, when the actual weight of the molecules becomes equal to their mutual repulsion, then, these two forces balancing one another, the molecules will rest altogether like the particles of a liquid. This must happen, therefore, on the top of the atmosphere, where it is possible to conceive a body whose specific gravity is less than the specific gravity of air in that state of rarefaction in which the repulsion of its molecules equals their weight to float on the surface exactly in the same manner, and for the same reason, as a ship floats on water, or, to come to a closer analogy, for the same reason that we see a balloon float between two strata of air when, bulk for bulk, it is lighter than that on which it presses, and heavier than that immediately above it. Now, admitting that the tendency to evaporation depends on the energy of the repelling force produced by the presence of heat having a tendency to drive off the stratum of particles which rest on the surface of the liquid, it will follow that gravity will, at length, balance or prevail over the repulsive force, and will prevent the particles from flying off or evaporating. Immediately before the liquid attains this state, the repulsive principle exceeds the gravitating one by so exceedingly small an amount, that the quantity of evaporation, though not exactly nothing, may be conceived to be so extremely small as to be utterly inappreciable by any direct sensible observation. Such is Faraday's reasoning, to prove that there exists a limit in all bodies to the action of the evaporating principle, and that this limit is very low in those bodies that fuse at low temperatures, and that it may be high in bodies which fuse at very high temperatures.

If it be admitted that the evaporating principle has no limit of this nature, it will follow that the atmosphere must always be impregnated with the vapors of all bodies, whether solid or liquid. It is difficult to imagine this to be the case, without supposing a great variety of chemical effects to be produced by such a confusion of substances, having such an indefinite variety of physical relations one to another. It seems much more probable that the less vaporizable substances at common temperatures are below the vaporizing limit, and that the atmosphere contains suspended in it chiefly the vapor of water, with slight and occasional admixtures of the vapors of the more volatile bodies.

The elevation of the average temperature of the air has a double effect on the rate of evaporation. By raising the temperature of water, it has a tendency to increase the rate; but by causing an increased quantity of vapor to be suspended in the air, it has, on the other hand, a contrary effect. The difference between the extreme tension due to the temperature and the tension of the vapor actually suspended is, perhaps, greater in warm than in cold weather, because in cold weather the atmosphere is nearer its point of saturation than in warm weather. Hence the rate of evaporation is probably greater in summer than in winter.

The method adopted by Dalton for determining the tension of vapor suspended in the atmosphere at any given time is, perhaps, in skilful hands, more exact than any which has since been discovered, especially if the glass vessel used be sufficiently thin. Dr. Thompson states that he has submitted to experiment other instruments for the same purpose, and this simple one, and that he is satisfied that the results obtained by the last are susceptible of the highest degree of accuracy.

Other instruments, however, have been contrived for determining the quantity of vapor suspended in the atmosphere, and are called *hygrometers*, or measurers of the moistness of the air. Such instruments are generally constructed from some substance which has a power of absorbing moisture, and which gives some external indication of the quantity which it absorbs.

The hygrometer of M. De Luc consists of an extremely thin piece of whalebone, which is stretched between two points and acts on the shorter arm of an index or hand, which plays on a graduated scale, like the hand of a clock. The effect of the whalebone absorbing moisture is to cause it to swell, and its length increases; and, on the contrary, when it dries, its length is contracted. The index is moved in the one direction or the other by these effects, and the space it moves over gives the change in the hygrometric state of the atmosphere.

The hygrometer of M. Saussure consists of a human hair, previously prepared by boiling it in a caustic ley. It then becomes a highly sensible absorbent of moisture. One extremity is suspended from a hook, and the other extremity carries a small weight which keeps it stretched. It is turned once round a grooved wheel, which moves an index playing on a graduated arch. As the hair contracts and expands by the effect of absorbing moisture, the wheel is turned in the one direction or the other, and the index shows the effect by moving through a corresponding portion of the arch.

That this instrument may indicate the absolute quantity of vapor suspended in the air, it was necessary that some fixed points upon it should be determined, analogous to the boiling and freezing points of water on a common thermometer. To effect this is, however, more difficult in the present case, inasmuch as the instrument is influenced at once by two causes, namely: by heat, and by the quantity of vapor suspended in the air. M. Saussure first considered the application of the instrument when exposed to an invariable temperature. He placed it in a vessel which contained perfectly dry air at the proposed temperature. He thus obtained the point of extreme dryness. He then successively introduced into the receiver several small known quantities of water. This he accomplished by depositing the liquid on small pieces of linen, which he weighed exactly, and determined the quantity of liquid thus introduced. When each successive portion of the liquid was vaporized, he observed and marked the indication of the hygrometer. He then withdrew them and weighed them again, thus determining exactly the quantity of liquid evaporated on each occasion.

Having repeated very often the experiment at the same temperature, he found that whatever variation the hygrometer had previously undergone, it always returned to the same point when the quantities of water vaporized in the receiver were equal. He found the same result at various temperatures, the indications at the same temperature being always the same; but the absolute quantity of water necessary to be vaporized in the space, in order to move the hygrometer through the same number of degrees, was different at different temperatures. To obtain, therefore, the actual quantity of water suspended in the form of vapor, it is necessary at the same time to observe the indications of the thermometer and hygrometer. These two indications are always sufficient for the exact solution of the question.

The hygrometer of Leslie is an instrument by which the hygrometric state of the air is indicated by the rate at which water evaporates. The bulb of an air thermometer is covered with silk or bibulous paper, which is moistened. The moisture evaporating produces cold in the bulb, and immediately affects the thermometer. The rapidity of the evaporation thus indicated depends on the temperature of the air, and the quantity of moisture it contains. This instrument, however, is a very imperfect indicator of the hygrometric state of the atmosphere.

The beautiful theory of evaporation, the details of which we have attempted to explain in the present, and in other lectures, and for the principal part of which the world is indebted to the genius of Dalton, affords a full and satisfactory elucidation of innumerable phenomena which present themselves in atmospheric and meteorological effects, and in all the processes of science and art.

It has been already explained, that when two liquids, such as water and alcohol, which combine with a weak affinity, are mixed together, their combination is destroyed by the process of vaporization, and each liquid vaporizes at a given temperature, in the same manner that it would do if it were vaporized independently of the other. The process of the distillation of spirits depends on this principle. Let us suppose that a liquid, composed principally of water and alcohol, is placed in a boiler or *still*, which communicates by a tube with a refrigeratory or *cooler*, which is capable of condensing into a liquid the vapor which passes from the still through it. If this mixture be raised to a temperature nearly as high as that at which the alcohol would boil, a vapor will rise composed of the vapor of water and the vapor of alcohol, mixed mechanically. Now it will be recollected, that the specific gravity or density of the vapor of alcohol at its boiling point, is about three and a half times that of the vapor of water at 212° ; and again, the density of the vapor of water at 212° is double the density of the vapor of water at 180° . Hence it follows, that the density of the vapor of alcohol at its boiling temperature, 180° , will be about seven times the density of the vapor of water at the same temperature.

Thus in the steam produced from the mixture of equal parts of water and alcohol, we shall have the proportion of alcohol to water in the ratio of 7 to 1. This, when condensed in the refrigeratory, will give a strong spirit. By repeating the process of distillation, the mixture may be more and more separated from the water which it contains.

If the distillation be conducted under a diminished pressure, or in a vacuum, the liquid will boil at a much lower temperature; and the portion of aqueous vapor which will be disengaged will be of such a small degree of density as at length to become insensible.

The principle on which the process of distillation in general, therefore, depends, is, that the constituent parts of the mixture boil at different temperatures; and that, if the mixture be caused to vaporize by heat, that part of it which boils at the lower temperature will vaporize in greater quantities than that which boils at the higher. When the vapor is condensed in the refrigeratory, a new mixture will then be obtained, containing a much greater quantity of that constituent part which boils at the lower temperature; and, on the other hand, the liquid which remains in the boiler will contain a greater portion of that which boils at the higher temperature. In general, by conducting the process in vacuo, or under diminished pressure, this object is more effectually attained, because less in proportion of the liquid which boils at the higher pressure will be vaporized in the process.

In some cases it happens that the temperature necessary to boil the liquid under ordinary pressure may be such as to decompose, or otherwise injure,

some constituent part of the mixture which it is important to preserve. For this reason, the above method is said to have been adopted with advantage in the distillation of vinegar, which it is impossible to distil in the ordinary way without giving it a peculiar burnt flavor; but by distilling it in vacuo, the vapor is raised at the temperature of 130° , and this effect is avoided.

In the process of sugar refining it was found that by raising the syrup to the necessary temperature, a risk was incurred of burning or decomposing it by too much heat. The method of boiling in vacuo was adopted by Mr. Edward Howard to remove this inconvenience. The syrup is thus concentrated to the granulating point without risk of decomposition. This method is now generally followed.

When vapor was produced from a liquid by ebullition, we have observed that a large quantity of heat was absorbed in the transition from the liquid to the gaseous form. The same effect attends the production of vapor from the surface, and, in fact, it is an indispensable consequence of the transition of a body into the vaporous form, at whatever temperature that transition takes place. In the formation of vapor, therefore, a quantity of heat must be supplied to the vapor formed, and must become latent in it; and this heat must be supplied either by the body itself or by surrounding objects. By whatever means it is supplied, the object which communicates it must undergo a corresponding depression of temperature; and hence vaporization becomes a means for the production of cold, on a principle precisely analogous to that of freezing mixtures.

This principle is illustrated by the method used to cool water for domestic purposes in hot countries. The water is placed in certain porous vessels, called in the East *alcarrazas*, and these are suspended in a current of air: as, for example, between two open doors. The vessel allows the water to penetrate it, and thus exposes it more effectually to evaporation, as well from the surface of the liquid itself, as from the exterior surface of the vessel containing it. As the vapor is formed, a quantity of latent heat is necessary for it; and this latent heat is supplied from the water contained in the vessel, which undergoes a corresponding depression of temperature.

The same effect can be made manifest by surrounding the bulb of a thermometer by a moist sponge, and exposing it to the sun. Let another thermometer be at the same time placed near it in the shade, and the thermometer surrounded by the sponge will be observed rapidly to fall, while the thermometer in its immediate neighborhood is stationary. This effect is evidently produced by the rapid evaporation of the water with which the sponge is saturated, and a corresponding depression of temperature produced in the liquid remaining in the sponge, arising from the heat supplied by it to the vapor.

The depression of temperature produced by evaporation will be more perceptible the more rapid is the evaporation, because then the body from which the heat is abstracted has not time to receive a supply of heat from surrounding objects to replace that which it has given out. Hence, by conducting the process of evaporation in a vacuum, where the evaporation is almost instantaneous, the cooling effect is more conspicuous. If a quantity of water included in the bulb of a thermometer tube be surrounded with a sponge moistened with ether, and placed under the receiver of an air-pump, the moment the air is withdrawn the ether suddenly evaporates; and if a sufficient quantity of ether be supplied, the water in the bulb will be frozen.

The same fact may be exhibited in a still more striking manner, by pouring some ether on the surface of water in a flat vessel. When the receiver placed over these is exhausted, the ether will boil in consequence of the removal of the atmospheric pressure, and its rapid evaporation will presently cause the

water under it to freeze. We shall thus have the singular exhibition of two liquids, one resting upon the other, the one boiling and the other freezing at the same moment; and, after the lapse of a few minutes, one altogether disappearing in the form of vapor,* while the other solidifies in the form of ice.

A beautiful experiment was contrived by Leslie, in which water is frozen on this principle. A shallow vessel containing water is placed under the receiver of an air-pump. Under the same receiver is placed a large flat dish, containing strong sulphuric acid. The receiver is now exhausted as rapidly as possible by the pump, and immediately the evaporation of the water takes place. If the sulphuric acid were not present, the space within the receiver would be saturated almost instantaneously with the vapor of the water, and all further evaporation would be stopped; but the sulphuric acid not being itself subject to sensible evaporation, has besides a strong affinity for water, by virtue of which it attracts the aqueous vapor, and causes it to be condensed on its surface. As fast, therefore, as the water evaporates, its vapor is seized upon by the sulphuric acid in the large dish, and the space within the receiver is still maintained a vacuum; so that the evaporation of the water continues as rapidly as in the first instance. Now the heat necessary to give the vaporous form to the water can only be received from the water itself which remains in the dish, and therefore it must undergo a rapid depression of temperature. It will speedily fall to the temperature of 32° , and in a few minutes will be frozen. By this process, conducted under favorable circumstances, Leslie was not only able to freeze water, but to congeal mercury; and it is said that he even produced a cold of -120° . The property on which this beautiful experiment is founded is not recommended alone by the surprise and pleasure which its result always produces; it is susceptible of useful application in chemistry when it is necessary to separate water from liquids which heat would decompose; and to dry animal and vegetable substances without exposing them to disorganization.

By the same method, the fact that ice itself, at all temperatures, is subject to evaporation, may be made manifest. If a few ounces of ice be placed under the receiver of an air-pump over a similar dish containing concentrated sulphuric acid, and the receiver be exhausted, the ice will altogether disappear in about twenty-four hours. During the whole of this time the temperature will be considerably below 32° . After the ice has disappeared the sulphuric acid will be found to be combined with water and to have increased its weight by the exact weight of the ice.

In climates where the temperature of the air never falls so low as the freezing point, and, therefore, where no natural ice ever exists, ice is obtained artificially by a cold produced by evaporation. In India it is obtained by making extensive shallow excavations in large open plains. In these water is exposed to evaporation in small earthen pots, unglazed, so as to be porous, and penetrable by water. Soft water, previously boiled, is placed in these vessels in the evening, in the months of December, January, and February. A part of it is usually frozen in the morning, when the ice is collected and deposited in pits, surrounded by straw and other bodies which exclude heat. Radiation, also, has a part in producing this effect as will be explained hereafter.

Evaporation being extensively used in the arts and manufactures, it has become a matter of considerable importance to conduct it with as much economy and expedition as possible. The circumstances which principally promote it being increase of temperature and a constant change in the air which is immediately above the evaporating surface, these two objects have received special attention. In factories where evaporation is used, the vessels containing the liquid to be evaporated, are usually placed where they shall be exposed to a

current of air passing over their surface. In cases where it has been found convenient to promote the evaporation by heating the liquid, the heat is frequently applied only to the surface, instead of being communicated by fire at the bottom of the vessel. In fact, the current of air which is made to pass over the surface of the evaporating liquid, is previously heated by forcing it through a fire. The flame of the fire is also, sometimes, made to play over the evaporating surface.

The coolers in breweries are large shallow vessels, exposing a considerable surface with a small depth of the liquid. They are commonly placed at the top of the building, and are open on every side to the air, so that in whatever direction a wind blows a current of air must pass over them. There are also provided a number of revolving fans, by which the stream of air in immediate contact with the evaporating surface, is continually kept in a state of agitation. The evaporation has a continual tendency to saturate the stratum of air immediately over the liquid, and by these expedients this stratum is caused to undergo a constant change; the air saturated with vapor being driven away, and a fresh portion supplying its place.

When salt is held in solution by water, the process of evaporation affects only the water, and loosens the connexion produced by the affinity of its particles for the molecules of the salt. If the solution, in this case, be what is called a *saturated solution*, that is, if it contain as much salt as the water at the given temperature is capable of sustaining, then the least quantity of evaporation must be attended with a deposition of crystals of salt in the liquid; and, if the evaporation be continued, the water will, at length, altogether disappear, and nothing but a mass of crystallized salt will remain.

This principle forms the basis of the method by which salt is obtained from sea-water. The water is received into a number of large shallow ponds, lined with clay, and prepared on the seashore. The water, being received into these, and dammed in, is left exposed to the weather in the heat of summer. If the weather be dry, the quantity of evaporation will considerably exceed the quantity of rain, and large surfaces being exposed in proportion to the depth of water in the pits, the water will be gradually dissipated, and will at length, altogether disappear, and a quantity of what is called *bay salt* will remain behind. This salt is said to be the fittest for the purpose of curing fish.

When ice cannot be obtained, wine may be cooled in various ways by the process of evaporation. If a moist towel be wrapped round a decanter of wine and exposed to the sun, the towel in the process of drying will cool the wine; for the wine must supply a part of the latent heat carried off by the vapor in the process of drying the towel. Wine-coolers constructed of porous earthen ware act on a similar principle. The evaporation of water from the porous material reduces the temperature of the liquid immediately surrounding the wine. Travellers in the Arabian deserts keep the water cool by wrapping the jars with linen cloths which are kept constantly moist.

Historians mention that the Egyptians applied the same principle to cool water for domestic purposes. Pitchers containing the water were kept constantly wet on the exterior surface during the night, and in the morning were surrounded by straw to intercept the communication of heat from the external air.

In India the curtains which surround beds are sprinkled with water, by the evaporation of which the air within the curtains is cooled.

The absorption of heat in evaporation will enable us easily to comprehend the danger arising from wearing damp clothes, or from sleeping in a damp bed. In the animal economy there is a source, the nature and operation of which is

not understood by us, by which heat is generated in the system, and is continually given out by the body. If any cause withdraws heat faster from the body than it is thus produced, a sensation of cold is felt; and if, on the contrary, the heat be not withdrawn as fast as it is generated, the body becomes unduly warm. A balance should, therefore, as much as possible, be maintained between the natural power of the body in the production of heat, and the faculty of receiving that heat in surrounding objects. In cold weather all surrounding objects being at a much lower temperature than the body, have a tendency to receive heat faster than the body can supply it, and in this case, artificial sources of external heat are sought, by which the temperature of surrounding objects may be raised, so as to accommodate themselves to the animal system. In very hot weather, on the contrary, the temperature of surrounding objects is so near the temperature of the body, that the heat produced in the system is not received with sufficient facility to keep the body sufficiently cool. In this case, artificial means of keeping down the temperature of the body are necessarily resorted to.

If the clothes which cover the body are damp, the moisture which they contain has a tendency to evaporate by the heat communicated to it by the body.

In fact, the body, in this case, is circumstanced exactly in the same manner as the bulb of a thermometer, already described, surrounded by a damp sponge, in which case we saw that the mercury rapidly fell. The heat absorbed in the evaporation of the moisture contained in the clothes must be, in part, supplied by the body, and will have a tendency to reduce the temperature of the body in an undue degree, and thereby to produce cold. The effect of violent labor or exercise is to cause the body to generate heat much faster than it would do in a state of rest. Hence we see why, when the clothes have been rendered wet by rain, or by perspiration, the taking of cold may be avoided by keeping the body in a state of exercise or labor until the clothes can be changed, or till they dry on the person; for in this case, the heat carried off by the moisture in evaporating is amply supplied by the redundant heat generated by labor or exercise.

A damp bed, however, is an evil which cannot be remedied by this means, the object of bed-clothes being to check the escape of heat from the body, so as to supply at night that warmth which may be obtained by exercise or labor during the day. This end is not only defeated, but the contrary effect produced, when the clothes by which the body is surrounded, contain moisture in them. The heat supplied by the body is immediately absorbed by this moisture, and passes off in vapor; and this effect would continue until the clothes were actually dried by the heat of the body.

A damp bed may be frequently detected by the use of a warming-pan. The introduction of the hot metal causes the moisture of the bed-clothes to be immediately converted into steam, which issues into the open space in which the warming-pan is introduced. When the warming-pan is withdrawn, this vapor is again partially condensed, and deposited on the surface of the sheets, the dampness will be then distinctly felt, a film of water being, in fact, deposited on their surface.

The danger of leaving damp or wet clothes to dry in an inhabited apartment, and more especially in a sleeping-room, will be readily understood from what has been just explained. The evaporation which takes place in the process of drying causes an absorption of heat, and produces a corresponding depression of temperature in the apartment.

A striking example of the effects of cold produced by evaporation is exhibited in an experiment contrived by Dr. Wollaston, and made with an instrument which

he called a *cryophorus*. This instrument consisted of a glass tube, A B, fig. 1, furnished with two bulbs, C D, placed on short branches at right angles to it.

Fig. 1.

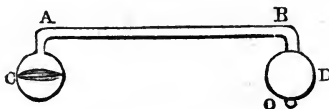

A small quantity of water is introduced through a short tube, which proceeds from the bottom of the bulb D at O. It is boiled in C until the space above C, and tube A B, and the bulb D, is completely filled with aqueous vapor to the exclusion of atmospheric air. The tube O is then closed by melting it with a blowpipe, so that the interior of the apparatus now contains nothing but water. When the instrument cools, the vapor is condensed, and such a vapor only subsists in the instrument as corresponds to the temperature of the water in C. If the bulb D be now surrounded by a freezing mixture, or exposed to any intense cold, the vapor produced from the water in C will be condensed in it, so that the space above the water in C, and in the tube A B, will be constantly prevented from attaining the state of saturation. The evaporation will then be continued, and the latent heat of the steam must be chiefly derived from the sensible heat of the water remaining in C. The temperature, therefore, of this water will be rapidly depressed until it reaches the freezing point, when it will be solidified.

When an ink bottle has a large mouth, the surface of the liquid in it will be exposed to a rapid evaporation; and, as this evaporation affects only the aqueous part of the liquid, the effect will be, that the ink will first become thick, and, if exposed a longer time, the whole of the liquid portion of it will pass off, and nothing but the hard coloring matter will remain. If, however, the mouth of the bottle be contracted to a small aperture, sufficient to receive a pen, the rate of evaporation will be considerably diminished; for, although the surface of ink in the bottle may be large, yet the evaporation having, in the first instance, saturated the space between the surface of the ink and the mouth of the bottle, no farther evaporation could take place, if that mouth were stopped; but, if it be opened, then a portion of the vapor, contained in the bottle above the surface of the liquid, will escape from it into the strata of air immediately above; but this portion will be less in proportion as the mouth of the bottle is small. It will, therefore, be found that ink will be less liable to thicken in ink-bottles having a small aperture than in those which have a large aperture; but the thickening of ink may be altogether avoided by the use of ink-bottles which, while they are capable of containing a considerable quantity of ink, expose a very small surface to evaporation. Such bottles are constructed like bird-cage fountains. A B, fig. 2, is a glass bottle, completely closed at the top, and hav-

Fig. 2.

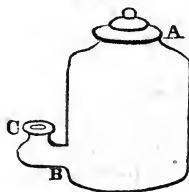

ing a tube, C, proceeding laterally from the bottom turned upward, where there is a small mouth large enough to receive a pen. The bottle is filled by incli-

ing the closed part, A B, slightly downward, and pouring the ink in at C, held in a slanting position. When the bottle is placed in the upright position, the surface of the ink in the bottle will remain above the surface of the ink in C, because the atmospheric pressure acting in C will balance the weight of the ink in A B, together with the pressure of the air confined in A B. The evaporation from the surface in A B having saturated the space above it will cease, and the only evaporation which will have a tendency to thicken the ink will be that which takes place at the surface in C; but this surface being very small, the evaporation will be inconsiderable. In such an ink-bottle ink may remain several months without thickening.

The reciprocal processes of evaporation and condensation are the means whereby the whole surface of that part of the globe which constitutes land is supplied with the fresh moisture and water necessary to sustain the organization and to maintain the functions of the animal and vegetable world. Thence sap and juice are supplied to vegetables, and fluids to animals; rivers and lakes are fed, and carry back to the ocean their waters, after supplying the uses of the living world.

The extensive surface of the ocean undergoes a never-ceasing process of evaporation, and dismisses into the atmosphere a quantity of pure water proportionate to its extent of surface and the temperature of the air above it, and to the state of that air with respect to saturation. This vapor is carried with currents of air through every part of the atmosphere which surrounds the globe.

When by various meteorological causes the temperature of the air is reduced, it will frequently happen that it will come below that limit at which the suspended vapor is in a state of saturation. A deposition or condensation will therefore take place, and rain or aqueous clouds will be formed. If the condensed vapor collect in spherical drops, it will be precipitated, and fall on the surface of the earth in the form of rain; but, from some unknown cause, it frequently happens that, instead of collecting in drops, the condensed vapor is formed into hollow bubbles, enclosing within them a fluid lighter, bulk for bulk, than the atmosphere. These bubbles are also found to have a repulsive influence on each other, like that of bodies similarly electrified. They float, therefore, in the atmosphere, their mutual repulsion preventing them coalescing so as to form drops. In this state, having by the laws of optics a certain degree of opacity, they become distinctly visible and form clouds.

The vapor suspended in the air during a hot summer's day is so elevated in its temperature as to be below the point of saturation, and therefore, though the actual quantity suspended be very considerable, yet, while the air is capable of sustaining more, no condensation can take place; but in the evening, after the sun has departed, the source of heat being withdrawn, the temperature of the air undergoes a great depression, and the quantity of vapor suspended in the atmosphere, now at a lower temperature, first attains and subsequently passes the point of saturation.

A deposition of moisture then takes place by the condensation of the redundant vapor of the atmosphere, and the small particles of moisture which fall on the surface, coalescing by their natural cohesion, form clear, pellucid drops on the surface of the ground, and are known by the name of *dew*.

The clouds in which the condensed vesicles of vapor are collected, are affected by an attraction which draws them toward the mountains and highest points of the surface of the earth. Collected there, they undergo a change, by which they form into drops, and are deposited in the form of rain; and hence, by their natural gravitation, they find their way through the pores and interstices of the earth, and in channels along its surface, forming, in the one case, wells and

springs in various parts of the earth, where they find a natural exit, or where an artificial exit is given to them, and, in the other case, obeying the form of the surface of the country through which they are carried, they wind in narrow channels, first deepening and widening as they proceed, and are fed by tributary streams until they form into great rivers, or spread into lakes, and at length discharge their waters into the sea.

The process of evaporation is not confined to the sea, but takes place from the surface of the soil, and from all vegetable and animal productions. The showers which fall in summer, first scattered in a thin sheet of moisture over the surface of the country, speedily return to the form of vapor, and carry with them, in the latent form, a quantity of heat, which they take from every object in contact with them, thus moderating the temperature of the earth, and refreshing the animal and vegetable creation.

A remarkable example of evaporation on a large scale is supplied by that great inland sea, the Mediterranean. That natural reservoir of water receives an extraordinary number of large rivers, among which may be mentioned the Nile, the Danube, the Dnieper, the Rhone, the Ebro, the Don, and many others. It has no communication with the ocean, except by the straits of Gibraltar, and there, instead of an outward current, there is a rapid and never-ceasing inward flow of water. We are, therefore, compelled to conclude that the evaporation from the surface of this sea carries off the enormous quantity of water constantly supplied from these sources. This may, in some degree, be accounted for by the fact, that the Mediterranean is surrounded by vast tracts of land on every side except the west. The wind, whether it blow from the south, the north, or from the east, has passed over a considerable extent of land, and is generally in a state, with respect to vapor, considerably below saturation. These dry currents of wind, coming in contact with the surface of the Mediterranean, draw off water with avidity, and, passing off, are succeeded by fresh portions of air, which repeat the same process.

CONDUCTION OF HEAT.

Conducting Powers of Bodies.—Liquids Non-Conductors.—Effect of Feathers and Wool on Animals.—Clothing.—Familiar Examples.

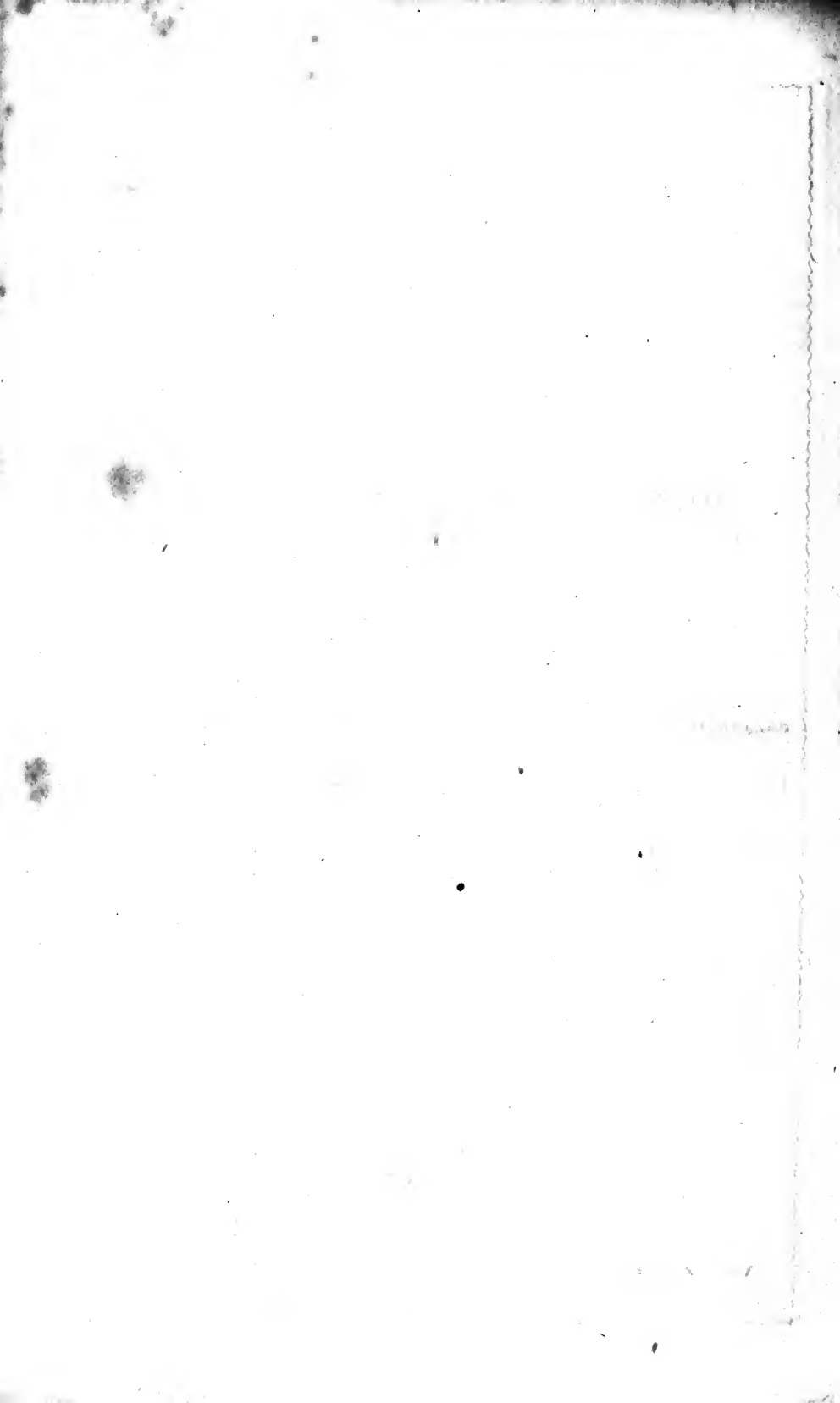

CONDUCTION OF HEAT.

IF two solid bodies, having different temperatures, be placed in close contact, it will be observed that the hotter body will gradually fall in temperature, and the colder gradually rise, until the temperatures become equal. This process is not, like radiation, sudden, but very gradual; the colder body receives increased temperature slowly, and the hotter loses it at the same rate. Different bodies, however, exhibit a different facility in this gradual transmission of heat by contact. In some it passes more rapidly from the hotter to the colder, and in others the equalization of temperature is not produced until after the lapse of a considerable time.

This quality in bodies, by which heat passes from one to the other through their dimensions, is called their *conducting power*, and the heat thus transmitted is said to be *conducted* by the body. One body is said to be a *better conductor* than another, when the equalization of temperature is effected more speedily; and when the equalization is accomplished more slowly, the body is said to be a *bad conductor*.

To make this process more intelligible, let us suppose A, fig. 1, a small square block of red-hot iron, and let B C be a bar of iron, the section of which

Fig. 1.

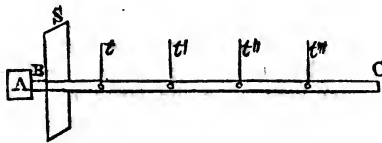

is square. Let the extremity, B, be placed close against the block A, and let a screen, S, pierced by A B, be placed so as to intercept the effect of radiation from A. Let thermometers, t , t' , &c., be inserted at different points of the bar

B C, in small cavities provided for the purpose and filled with mercury. This mercury will take the temperature of the bar, and will communicate it to each thermometer successively. Before the bar is placed in contact with the red-hot block A, the thermometers will all indicate the same temperature. At the first moment, when the bar is placed in contact with A, none of the thermometers will be affected by it; but, after the lapse of a short time, the first thermometer, t , will be observed to rise slowly; after another interval, the thermometer t' will begin to be affected; and the other thermometers, after like intervals, will be successively affected in the same way; but the thermometer t , by continuing to rise, will indicate a higher temperature than t' , and t' a higher temperature than t'' , and so on. After the lapse of a considerable time, the temperatures of all the thermometers will be the same; and if the block A be observed, it will be found to have the common temperature indicated by all the thermometers.

It appears, from this experiment, that the propagation of heat in this manner through the dimensions of the bar is very slow, and it would seem to take place from particle to particle of the matter composing the bar. The first particle in contact with the source of heat acquires a certain temperature; this being greater than the contiguous particles, an interchange takes place between the two, on a principle exactly similar to the interchange of heat by radiation. In fact, two contiguous particles in this case may be regarded, under the same circumstances, as two bodies having different temperatures placed in the foci of the two reflectors, $f f$, fig. 2. In that case, the hotter body radiates heat

Fig. 2.

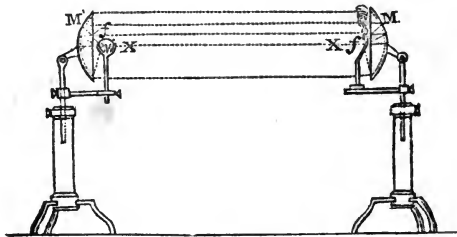

on the colder, and the colder on the hotter, in unequal quantities, until their temperatures are equalized. Every two successive particles in the bar B C, fig. 1, beginning from the source of heat, appear to act on each other in the same way.

Let a number of bars of different substances of equal dimensions, be successively exposed in this manner, to the same source of heat, and let thermometers be applied to similar points in them, it will be found that thermometers in the same situation on different bars, will, after the lapse of the same time from the commencement of the contact, be differently affected. In those bars which are good conductors the thermometer will be more elevated than in those which are bad conductors; and, in general, the conducting power of the different bars may be estimated by the effect produced on thermometers at a given distance from the source of heat, after the lapse of a given time. In experiments of this nature it is, however, necessary to guard against the effects of radiation; because, if two different bars radiate differently, it is possible that the indications of the thermometer may be so interfered with, by their different powers of radiation, that their conducting power cannot, with certainty, be inferred. In a course of experiments instituted on this subject by Despretz, he

employed bars of the same size, covered with a coating of varnish. Heat was applied by a lamp at one end, and its progress along the bar indicated by a thermometer at the other; the lamp was applied until its utmost effect on the thermometer was ascertained; and the greatest heat to which the thermometer could thus be raised by the effect of the lamp, was taken as the measure of the conducting power of the bar. The following table exhibits the results of Despretz's experiments on different substances:—

	Conducting power.
Gold,	100
Platinum,	98.1
Silver,	97.3
Copper,	89.82
Iron,	37.41
Zinc,	36.37
Tin,	30.38
Lead,	17.96
Marble,	2.34
Porcelain,	1.22
Brick earth,	1.13

From this table it is obvious that the metals are, by far, the best conductors of heat, and that the conducting power of earthy substances is prodigiously inferior.

Similar experiments were made on different species of wood, by MM. A. Delarive, and A. Decandolle. From these experiments it appears that, generally, the more dense woods are those which conduct heat best. This rule, however, is not invariable, for the conducting power of nut-wood was found to be considerably greater than that of oak. It was, also, found, that heat was better conducted in the direction of the fibres than across them.

In bodies of the same kind, the rate at which heat is conducted, from the hotter to the colder, depends on the extent of the surface of contact, and is proportional to that surface. Thus if two spheres or balls of metal, at different temperatures, be placed in contact, they will touch only in a single point, and the transmission of heat will be extremely slow; but if two cubes of the same metal be placed face to face, their surface of contact will be considerable, and the transition of heat will be proportionally rapid.

Bodies of a porous, soft, or spongy texture, and especially those of a fibrous nature, such as wool, feathers, fur, &c., are the worst conductors of heat. Such a body may be placed in contact with another body of a much higher or much lower temperature than itself, without exhibiting any change of temperature, for a long period of time.

From what has been above explained, it appears that, besides a tendency to equilibrium of temperature, which arises from the interchange of heat by radiation, bodies have a like tendency to calorific equilibrium by the transmission of heat by contact. After the lapse of a sufficient time, every two bodies in contact distribute between them the heat they contain in such portions as to render their temperature equal. The manner in which this effect is, generally, produced in liquids and gases differs, however, materially from the nature of the process in solids. The constituent particles of solid bodies being incapable of changing their material position and arrangement, the heat can only pass through them, from particle to particle, by a slow process; but when the particles forming any stratum of a liquid are heated, their mass, expanding, becomes lighter, bulk for bulk, than the stratum immediately above it, and ascends, allowing the superior strata to descend. Thus a source of heat applied to the bottom of a vessel containing a liquid, immediately causes the liquid near the bottom to form an upward current, while the superior liquid forms a downward

one; and a constant series of currents upward and downward is thus established. The portion of the liquid which receives heat below, is thus continually mixed through the other parts, and the heat is diffused by the motion of the particles among each other; the same effect takes place in gases. If a lower stratum be heated, it acquires a tendency to ascend to the higher, and the colder strata descend.

If, however, heat be applied to the highest stratum of the liquid, this effect cannot ensue; and it is found that, in this case, the particles maintaining their mutual arrangement, the transmission of heat takes place in the same manner as if the liquid were solid. In fact, the heat is, in this case, *conducted* through the liquid. Liquids, in this manner, are observed to have extremely low conducting powers; so low that, for a long period, they were supposed to be altogether incapable of conducting heat. They have been ascertained by experiment, however, not to be altogether destitute of the power of conduction.

Let a small quantity of spirits of wine be poured on the surface of water, at the temperature of 32° , and let a thermometer be immersed in the water at a small depth below the common surface of the water and spirits; let the spirits be now inflamed and caused to burn on the surface of the water. After the lapse of a considerable time the thermometer will show a very slight indication of increased temperature, by the downward transmission of heat from the burning spirits.

This, and other experiments of a like nature, are extremely difficult of management, and very uncertain in their results. It often happens that the elevation of the thermometer is caused by currents of the liquid produced by heat conducted downward by the sides of the vessels containing the liquid. Although the liquid itself may fail to conduct the heat downward, yet the vessel containing it, having a better conducting power, will transmit the heat to inferior strata of the liquid, and currents may thus, to a certain extent, be established. An ingenious method of evading this difficulty was suggested by Mr. Murray, who conducted the experiment in vessels composed of ice. The heat received by the sides of the vessel was, in this case, expended in the liquefaction of the ice, and had no tendency, therefore, to disturb the result of the investigation.

The process of cooling, which a hot body undergoes when suspended in air, is chiefly owing to the radiation of heat from its surface: but another cause of the diminution of heat conspires with this. The particles of air in contact with the surface of the body, receive heat from it, and thus becoming specifically lighter by their dilatation, ascend, and give place to others, on which a like effect is produced. Thus heat is imparted, constantly, to fresh portions of the air, and carried off by them. If a hot body be suspended in a liquid, the process, as to its cooling, is altogether produced by this means, for in that case no radiation takes place.

The covering of wool and feathers, which nature has provided for the inferior classes of animals, has a property of conducting heat very imperfectly, and hence, it has the effect of keeping the body cool in hot weather, and warm in cold weather. The heat which is produced by powers provided in the animal economy, within the body, has a tendency, when in a cold atmosphere, to escape faster than it is generated, the covering being a non-conductor, intercepts it, and keeps it confined.

Man is endowed with faculties which enable him to fabricate, for himself, covering similar to that with which nature has provided other animals. Clothes are generally composed of some light, non-conducting substances, which protect the body from the inclement heat or cold of the external air. In summer, clothing keeps the body cool, and in winter, warm. Woollen substances are

worse conductors than those composed of cotton or linen. A flannel shirt more effectually intercepts heat than a cotton or a linen one; and whether in warm or in cold climates, attains the end of clothing more effectually.

If we would preserve ice from melting, the most effectual means would be to wrap it in blankets, which would retard, for a long time, the approach of heat to it from any external source.

Glass and porcelain are slow conductors of heat, and hence may be explained the fact, that vessels formed of this material are, frequently, broken by suddenly introducing boiling water into them. If a small quantity of boiling water be poured into a thick glass tumbler, the bottom, with which the water first comes into contact, is suddenly heated, and it expands; but the heat, passing very slowly through it, fails to affect the upper part of the vessel, which, therefore, undergoes a corresponding expansion: the lower part enlarging, while the upper part remains unaltered, a crack is produced, which detaches the bottom of the tumbler from the upper part of it.

In the construction of an ice-house, the walls, roof, and floor, should be surrounded with some substance which conducts heat imperfectly. A lining of straw-matting, or of woollen-blankets, will answer this purpose. Air being a bad conductor of heat, the building is, sometimes, constructed with double walls, having a space between them. The ice is thus surrounded by a wall of air, as it were, which is, in a great degree, impenetrable by heat, provided no source of radiation be present. Furnaces, intended to heat apartments, should be surrounded with non-conducting substances, to prevent the waste of heat.

When wine-coolers are formed of a double casing, the space between may be filled with some non-conducting substance, such as powdered charcoal, or wool, or it may be left merely filled with air.

The practical application of non-conduction is illustrated in the construction and management of the boilers and steam-pipes of steam-machinery.

In places where fuel is expensive and consumed in great quantity, every possible expedient that can conduce to its economy is resorted to. In Cornwall, where very powerful engines are worked for the drainage of the mines and the preparation of the ore, and to which fuel has to be carried from a considerable distance, the boilers are surrounded by a hollow casing, stuffed with *saw-dust*. This is found to be a nearly perfect non-conductor of heat. All the pipes which conduct steam to the cylinders are similarly coated. The consequence of this is, that the boiler-houses, notwithstanding the large furnaces continually burning in them, are extremely cool rooms, and in summer are much cooler than the external atmosphere. The steam cylinders are also, sometimes cased in wood.

In the machinery used in the British steamships, it has been the practice to invest the boiler with a coating of patent felt and to cover the great steam-pipe in the same manner. This non-conducting coating prevents the constant waste of steam by the condensation produced by radiation.

Charcoal in powder is a good non-conductor of heat, and is sometimes used to protect ice from fusion.

Fresh provisions are sometimes exported to distant places enveloped in ice. In this case it would be advantageous to envelope the ice itself in a casing of *saw-dust*.

In concluding these discourses on heat, it may be proper to enumerate the most ordinary sources of this principle. They may be stated as follows:—

1. Solar Light.—The sources from which heat might, by possibility, be radiated toward the earth from distant regions of the universe are, 1st, the sun;

2d, the planets, and satellites, and the moon; and 3d, the fixed stars. But it has been shown that the moon does not supply heat enough to affect the most delicate differential thermometer, even when condensed by a burning-glass. It follows, then, *à fortiori*, that the planets and satellites can produce no sensible effect. As to the stars, it has been proved that their heating power must be less than that of the sun in the same proportion as their apparent magnitude is less, and as no telescope has ever exhibited them with any sensible magnitude, however high the power, we may safely infer that their heating power is unappreciable.

2. Electricity is a source of heat in whatever manner it may be evolved.
3. The condensation of gases, solidification of liquids, and percussion or compression of solids.
4. Chemical combination and decomposition.
5. The functions of animal life.

RELATION OF HEAT AND LIGHT.

Probable Identity of Heat and Light.—Incandescence.—Probable Temperature of.—Gases cannot be made Incandescent.—The Absorption and Reflection of Heat depend on Color.—Burning Glass.—Heat of Sun's Rays.—Heat of artificial Light.—Moonlight.—Phosphorescence.

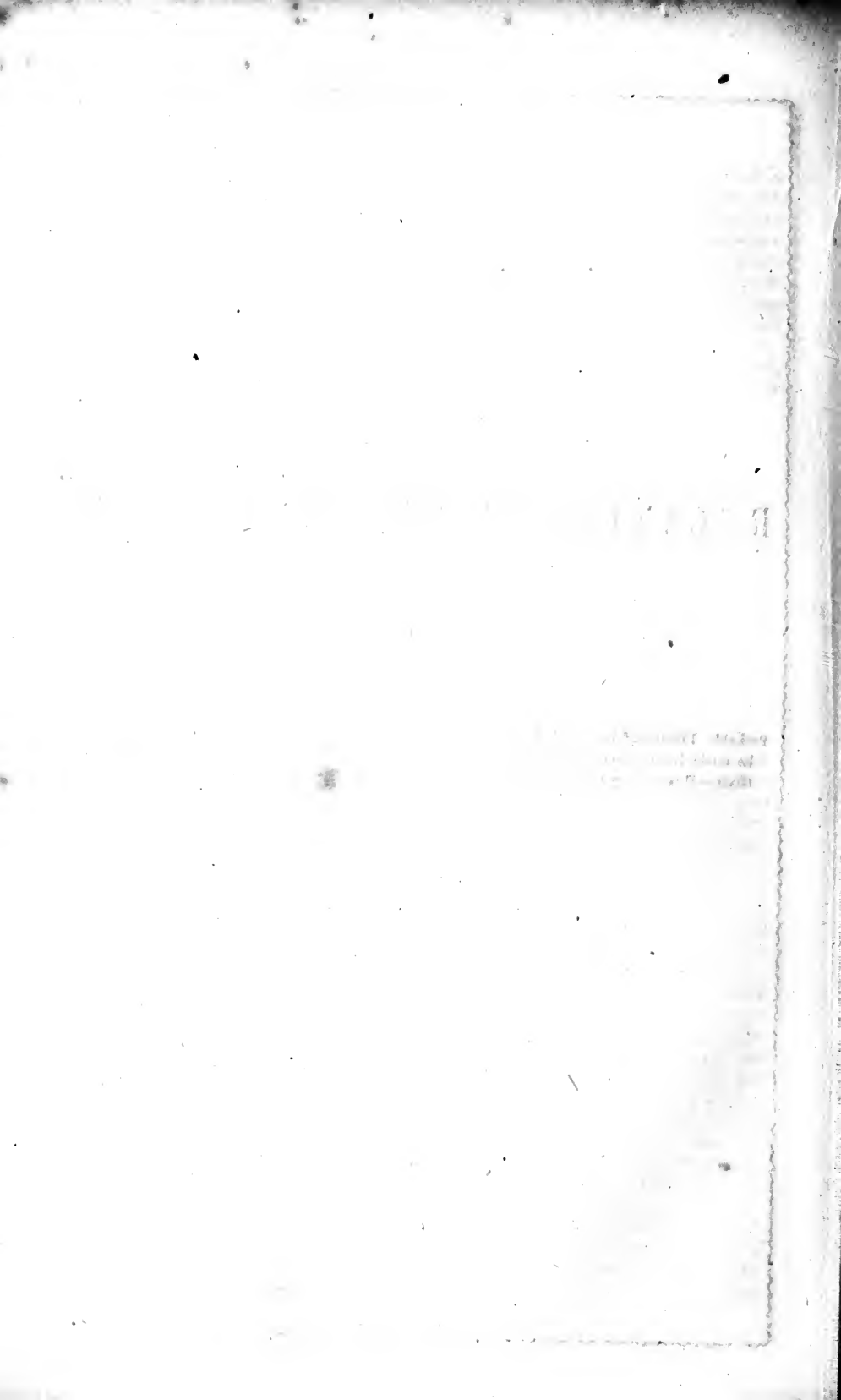

RELATION OF HEAT AND LIGHT.

THE whole body of natural phenomena in which the effects of heat and light are concerned, demonstrate an intimate physical connexion between these agents. Sunlight is warm, the light of red coals is warm, and the more brilliant light of flame excites still more intense heat. If every degree of light were productive of heat, and, reciprocally, every degree of heat productive of light, we should not hesitate to infer that heat and light are two distinct effects of the same physical principle; and such an inference would be corroborated if it appeared that the energy of the luminous and calorific effects were proportionate to each other, the most brilliant light always producing the most intense heat, and the most fierce temperature always accompanied by the strongest illuminating power.

Some of the more obvious phenomena countenance these views. All the ordinary sources of light, are also sources of heat; and by whatever artificial means natural light is condensed, so as to increase its splendor, the heat which it produces is at the same time rendered more intense. The direct rays of the sun, playing on the bulb of a thermometer, will elevate its temperature to a certain extent; but if a certain number of these rays be concentrated on the same bulb by a concave reflector, or burning lens, then the elevation of temperature will be much more sudden and extensive. These, however, are only the first and more prominent effects which obtrude themselves on our observation. It requires little attention to the phenomena of nature, much less to those which are exhibited by the processes of science and art, to discover that the heat which accompanies light is not always proportionate to the splendor of the light; and further, that heat of considerable intensity, both as regards the thermometric effects, and the sensation it produces, may be either absolutely accompanied by light, or, at least, if it have light, the intensity of that light is so small as to be below the limit of the sensibility of the eye.

The fact of the existence of heat unaccompanied by any sensible degree of

light, and of light unaccompanied by any sensible degree of heat, on the one hand, and of an extensive and complicated group of properties, in which light and heat agree in their physical characters, on the other, have given rise to two distinct hypotheses respecting the nature of these principles. By the one they are regarded as distinct physical agents, which enjoy some common properties, while on the other they are assumed to be the same principle manifesting itself in different ways, according to the property which, under different circumstances, acts with the greatest degree of energy. Our object at present shall be confined to the statement of the principal effects upon which one or the other theory must be founded, and which any theory must explain before its validity can be admitted.

If heat be communicated to solid bodies which are difficult of fusion, it is observed that after having absorbed a certain quantity, they begin to become luminous. If the process be conducted in a dark chamber, the body will gradually begin to be visible by emitting a dull red light. This luminous quality gradually increases as the body absorbs heat, and at length it emits sufficient light to render the surrounding objects visible; and the color of the light changes from an obscure, dusky red, gradually to the color of bright red. The body is then said, in common language, to be *red-hot*. If the communication of heat be still continued, the color of the light will change to an orange, and subsequently will become yellow. If the application of heat be still further continued, it will at length emit a clear white light, the color of sunlight; the body is then said to be *white-hot*.

The state in which a heated body naturally incapable of emitting light becomes luminous, is called a state of *incandescence*. The term *ignition* is sometimes applied to this state; but the former term is preferable, since ignition is sometimes used to express the commencement of inflammation or combustion, which is a process of a totally different nature.

The temperature at which a body becomes incandescent is extremely difficult to be ascertained with exactness, being beyond the reach of the mercurial thermometer. The uncertainty of the indications of pyrometers, and other means by which fierce temperatures are measured, has been before noticed. There are, however, some circumstances which render it probable that bodies in general, which have been rendered incandescent by increase of temperature, have attained that state at nearly the same temperature. Mr. Wedgwood placed some gilding on a piece of porcelain, and exposed both to the heat of an intense furnace, until the porcelain became red-hot: no difference could be observed in the time of the porcelain and the gilding upon it becoming luminous, yet these substances are of so very different a nature that it might be expected that a difference in their incandescence would be observable.

The point of fusion seems to have no relation whatever to the point of incandescence. While yet solid, some bodies attain a clear white heat without fusion. Others again, such as silver and lead, fuse before they become luminous. If the boiling point of a body be below its point of incandescence, it cannot attain the latter state unless its vaporization be resisted by pressure. It is supposed that liquids submitted to a pressure which will resist their vaporization, are capable of attaining a state of incandescence. Thus, in some experiments of Perkins, water is said to have been rendered red hot without being permitted to expand into vapor.

The determination of the temperature at which bodies become incandescent has occupied the attention of several distinguished philosophers. Newton fixed it at the temperature of 635° ; but there is no doubt that this is considerably below the true temperature. Newton possessed very imperfect means of determining the temperature, and measured it by observing the rate at which

red-hot iron cooled, calculating the heat lost by the time of cooling. Mercury boils at the temperature of 662° ; and yet it is certain that it emits no sensible light, since it is perfectly invisible in a dark room. Mr. Daniel, from experiments made with his pyrometer, fixed the temperature of incandescence at 980° ; but this, again, is proved to be higher than the true temperature of incandescence, since antimony, at its fusing point, is visible in the dark, and yet this metal melts at 810° . Sir Humphrey Davy fixed the temperature of incandescence at 812° .

The uncertainty attending the temperature at which incandescence commences cannot be surprising when we consider that besides the difficulty of accurately measuring high temperatures, there are no other means of determining the fact of incipient incandescence than the evidence of the sight. Now there are many reasons for concluding that sight is a very imperfect measure of illumination. Objects illuminated in different degrees, exhibited to the same individual, will give him very imperfect notions of their actual comparative brightness. Let two pieces of white paper be differently illuminated by common candles: let one be exposed to the light of a single candle, and the other to the light of ten candles, and let them be viewed by any number of individuals; it will be found that no two will agree in their estimates of the relative degree of illumination. If, then, the eye be so imperfect a judge of the degree of illumination, it is extremely probable that when the illumination becomes so faint as to be barely perceptible, it will begin to be perceived by different persons when it arrives at different degrees of intensity. It is extremely probable, if not certain, that the same object placed in a dark room will be pronounced to be luminous by one person, and not so by another; and it is absolutely certain that an object may be luminous to the eyes of certain animals when it is perfectly invisible to the human eye. Sight, therefore, is by no means a certain test of the presence of light, and, consequently, is an extremely inadequate means of determining the commencement of incandescence. If, however, incandescence be defined to be the commencement of that state in which, whether light be actually emitted or not, sufficient light is emitted sensibly to affect the human eye, then the temperature of incipient incandescence must be taken as the average or mean of the results given by different observers. In this sense we shall not, perhaps, be very wide of the truth if it be fixed at a temperature of between 700° and 800° . To attempt to fix the temperature more accurately would be inconsistent with the results of experience, and the imperfect nature of our means of estimating them.

Analogy would lead us to conclude that all bodies in the solid and liquid state are susceptible of incandescence. Since analogy, likewise, countenances the supposition that all bodies are susceptible of existing in these states, it is likewise probable that all bodies whatever are susceptible of incandescence. Practically, however, the attainment of the state of incandescence is rendered impossible in a vast number of bodies, from various causes. In some cases, long before the requisite increase of temperature can be attained the forces which hold the constituent parts of bodies together are destroyed by the antagonist forces introduced by the heat itself; so that the body is decomposed or resolved into its constituent parts. In other cases combustion takes place, by which the body to which heat is communicated, or some parts of it, combine with other elements, and form new compounds. These circumstances destroy the identity of the body, and cause a total change in its nature and constitution, long before incandescence can be looked for.

It is generally held that air and the gases form an exception to this general effect. No heat ever yet attained has rendered a body in the gaseous form red-hot; and yet such bodies have been certainly raised to a temperature sufficient

to render solids luminous. If, therefore, they be susceptible of incandescence, their point of incandescence must be far above the point of incandescence of bodies in the solid or liquid form. Mr. Wedgwood constructed a spiral tube of porcelain, which was carried through a crucible surrounded with sand. To one end of it was attached a pair of bellows, and the air thus driven through it was received from the other extremity into a globular vessel, furnished with a valve by which air was allowed to escape, but none to enter. In the side of this globular vessel was an opening, in which was inserted a piece of glass, through which the interior could be viewed. The sand in the crucible being then rendered red-hot, air was blown through the earthen tube, and made to pass into the glass vessel at the other end of the tube. When viewed through the glass in the side of the vessel, it was observed not to be luminous; but a piece of gold wire introduced into that part of the vessel near the mouth of the spiral tube, was immediately rendered red-hot by the blast of hot air which issued from it. The air, therefore, had a temperature at least equal to the temperature of the incandescence of gold.

Such experiments render it manifest that gases are incapable of attaining incandescence at the same temperature as that at which solids become luminous; but it appears to me that we cannot hence infer that the matter of the gas is not susceptible of incandescence, even at the temperature at which other bodies pass into that state; for if a gas were liquified, and confined by pressure so as to prevent it from dilating again into the form of gas, it is probable that in that state a quantity of heat would render it incandescent which would be altogether incapable of producing the same effect on it in the form of gas.

Established facts and analogy founded on them, therefore, lead to the conclusion, that if a sufficient quantity of heat be supplied to any body, that body will at length become luminous; and, therefore, that light is invariably a consequence of heat, when that heat attains a certain degree of intensity; the quantity of heat necessary for the production of light differing according to the nature of the body which contains that heat, those having a less specific heat requiring a less supply of heat to render them luminous.

Let us now inquire how far the presence of heat is a necessary consequence of the presence of light.

It has been proved that the least refrangible rays of solar light are those which possess the quality of heat in the highest degree; the most refrangible luminous rays, though still indicating the presence of the calorific principle, exhibit that in a very slight degree; while the invisible chemical rays, still more refrangible than these, produce no susceptible effect on the thermometer. We are, therefore, led to infer, that, in solar light, the heating qualities of the rays increase as their refrangibility diminishes.

When light falls on an opaque body, it is either wholly or partially absorbed. If it be generally absorbed, that portion which is not absorbed is reflected, or driven back into the space from which the light came. Now it is clear that, so far as light is the means of communicating heat to any opaque body under these circumstances, this heat must proceed altogether from the light which is absorbed.

It has been explained, that the solar light is composed of lights of several different colors. When this light falls on an opaque body, it happens that lights of certain colors are absorbed by the surface of the body, and the remainder of the solar light is reflected. On this fact depend all the phenomena of the colors of natural bodies. When a body appears to be of a red color, it reflects from its surface that portion of the sun's light which is red, and it absorbs all the other colors. Again, if a body appear green, it absorbs all the sun's light which strikes upon it except the green light, and that alone is reflected, and so

on; similar reasoning being applied to all other shades of color. If a body appears perfectly black, it absorbs all the sun's light, and reflects none; if it be perfectly white, it reflects all the sun's light and absorbs none; but perfect colors, whether black or white, or of whatever other tint they may be, do not exist in nature. No body exhibits an absolute black or an absolute white, however near these limits they may approach.

If an opaque body of any color be exposed to the direct rays of the sun, it will be observed to rise in its temperature, or become warm. If it be of a black color, it will exhibit a rapid and considerable increase of temperature. Next to black, a body of a blue color will absorb most heat; next follow green, yellow, and red, and white least of all.

That black should absorb most heat, and white least, follows immediately from the fact that a body of a black color absorbs nearly all the solar rays, and with them their heat; while a body of a white color reflects nearly all the rays, and with them reflects their heat. Of all the constituent parts of solar light, that which possesses the least *heating* power is the blue light. A body, therefore, which reflects this only, must absorb all the most powerful heating rays; and hence we see why an opaque object of a blue color receives the most heat, next to black. The green light has a certain heating power, less than the red or yellow, but more than the blue. A body, therefore, which reflects the green light, absorbing the others, reflects more heat than a blue or black object, but less than objects of those colors which occupy the lower part of the prismatic spectrum. Such a body, therefore, receives less heat from the solar light than those of a darker shade, and more than those of a lighter. The application of the same reasoning will explain why bodies of a yellow or red color absorb still less heat.

If several pieces of cloth, of the same size and quality, but of different colors—black, blue, green, yellow, and white—be thrown on the surface of snow in clear daylight, but especially in sunshine, it will be found that the black cloth will quickly melt the snow beneath it and sink downward. The blue will do the same, but less rapidly; the green still less so; the yellow slightly, and the white not at all. These effects illustrate the principle just explained. We see, also, that the warmth or coolness of clothing depends as well on its color as its quality. A white dress, or one of a light color, will always be cooler than one of the same quality of a dark color, and especially so in clear weather, when there is much sunshine. A white, or light color, reflects heat copiously, and absorbs little; while a black and dark color absorbs copiously and reflects little. From this we see that experience has supplied the place of science in directing the choice of clothing. The use of light colors always prevails in summer, and that of dark colors in winter.

Of transparent objects, some, such as air and the gases, are almost perfectly so, transmitting nearly all the light to which they are exposed. Such bodies are, consequently, invisible; since the light which passes through them, and which alone can affect the sight, suffers no effect different from that which it would undergo if they were not present, and if the space through which it passed were an absolute vacuum. Such bodies, since they arrest no portion of the light in its progress, receive no heat from it. The same is true of some liquids, as pure water; and of some solids, though in a less degree, as plate glass. The rays of solar light, passing through a pane of plate glass, produce little effect on its temperature; but some little effect is produced, since no glass, however pure, is perfectly transparent; but even were it admitted that glass and other transparent bodies were absolutely transparent to all the luminous rays of solar light, it might happen that they would absorb those invisible caloric rays which are proved to exist in it, and to be less refrangible than any

luminous rays. However, in general, so far as the transmission of sunlight is concerned, bodies which are absolutely transparent, or nearly so, are found to arrest an extremely small portion of the calorific principle of the sun's light. This effect, therefore, is generally consistent with the supposition that the calorific principle is a quality of the solar rays. But numerous bodies are imperfectly transparent, or transparent only to lights of a particular color; and in this respect transparent objects bear an analogy to opaque ones. The color of a transparent object when we look through it depends on the color of the light which it transmits. Thus stained glass exhibits various colors according to its quality when viewed from the interior of a window in which it is set. A piece of blue glass admits a blue light to pass through it, but intercepts other colors. Red glass, in like manner, allows a red light to penetrate it, but stops the passage of lights of other colors. The lights which are intercepted by partially transparent objects, are partly absorbed by them and partly reflected. The portion which is reflected is of that color which the object appears when viewed, no source of light being behind it; and the remainder is absorbed. Let us suppose that the light which penetrates a piece of stained glass were mixed with the light which is reflected, the mixture would not give the complete solar light which strikes upon it; the part which it absorbs would still be wanting; if that were added, the mixture of the three would form white solar light. Hence we see the reason why a window of stained glass exhibits one set of colors when viewed from the interior, and a different set of colors when viewed from the exterior. When viewed from the interior the color which it *transmits* is seen; when viewed from the exterior, only the color which it *reflects* is observed.

To determine the effects of the sun's light in heating a transparent object, it is necessary first to ascertain the color of the light transmitted through it, and next the color of the light reflected by it. These two colors being subtracted from the combination of color exhibited in the prismatic spectrum, the remainder will be the color of the light absorbed.

A partially transparent object, therefore, will always absorb most heat when the colors which it transmits and reflects are those which occupy the upper portion of the prismatic spectrum; for, in that case, the lights which it absorbs are those which occupy the lower portion of the spectrum, and are the most powerful in their calorific effects.

Hence we see the reason why the colored glasses used by Sir William Herschel to mitigate the sun's light in his telescopes, were so frequently cracked by the heat they absorbed. The splendor of the light in a large telescope, rendered it necessary to use glasses of a very dark color, and consequently such as absorbed the most calorific colors.

The calorific power of the sun's rays may be exhibited in a very conspicuous manner, by concentrating a large number of them into a small space, by means of a *burning-glass*. Such an instrument is usually formed either of a large concave reflector, by which the rays, falling on an extensive surface, are reflected in lines which all tend toward one point, or by a large convex lens of glass, which, when the rays pass through it, bend them, or refract them, in directions converging all to the same point. In either case, the effect of the rays is increased in the proportion which the magnitude of the point into which they are collected bears to the magnitude of the reflector or the lens. From experiments performed in this way by Count Rumford, it appears, however, that no change in the heating power of individual rays is produced by this means, and that the increased energy of their calorific action arises altogether from a great number of them being concentrated in a small space.

The heating power of the sun's rays, when collected by a burning-glass, far

exceeds the heat of a powerful furnace. A piece of gold placed in the focus of such a glass, has not only been melted, but has actually been converted into vapor, by Lavoisier. This fact was proved by a piece of silver placed at some height above the gold, having been gilded by the condensation of the vapor of the gold on its surface.

Artificial lights are generally accompanied by heat in various degrees, and, generally, the more intensely brilliant the light, the more powerful will be the calorific effects. It would appear, however, from some remarkable differences which are observed in the transmission of artificial light through transparent bodies, that the invisible calorific rays exist in such light in a much greater proportion than in solar light. If a screen of plate-glass be placed before a coal fire, although scarcely any light will be intercepted, nearly all the heat will be immediately stopped. This has been generally adduced as a proof that light and heat are distinct principles, since the glass, in this case, is said to separate them. The effect, however, admits of explanation with equal facility, on the supposition that heat is a quality of light, and that the luminous property may have so weak a force in some rays, as to be incapable of affecting the sight. The light from the fire, in the case just mentioned, is generally of a red color, like that of the rays at the lowest point of the luminous spectrum; it is probable, therefore, that it may contain also the more calorific invisible rays which are, in that neighborhood, in the spectrum. If this be admitted, the light emitted by a fire will consist of a much larger proportion of the invisible calorific rays than is found in sunlight. The proportion, therefore, which the visible rays transmitted by the glass bears to the invisible rays which may not be transmitted, will be much less than in sunlight, and consequently the rays transmitted by the glass will possess comparatively a much less heating power.

One of the most remarkable exceptions to the general fact, that the presence of light necessarily infers the presence of heat, is the fact, that moonlight, in whatever degree it can be concentrated by the most powerful burning-glasses, has never yet been found to affect the most sensible thermometer. De-la-Hire collected the rays of the full moon, when on the meridian, by a burning-glass of about three feet in diameter, in the focus of which he placed a delicate air thermometer. The density of the lunar rays was in this case increased in the proportion of about 300 to 1, and yet not the slightest effect was produced. This anomaly is, however, easily accounted for. Admitting that the moon absorbs no part of the invisible calorific rays of the solar light, it will follow that the heating power of moonlight cannot be in a greater proportion to that of sunlight than the relative brilliancy of the two lights. Now, to determine the comparative splendor of moonlight and sunlight, let the moon, when seen in the firmament during the day, be compared with a white cloud near it; its brightness, and that of the cloud, will appear very nearly the same. Assuming that they are exactly the same, it will follow that in the day, when the whole firmament is covered with white fleecy clouds, the brilliancy of the light would be the same as if the whole firmament were covered with an illuminated surface similar to that of the moon. The light, therefore, of a cloudy day of this kind, will be as much more brilliant than the light of the moon, as the magnitude of the whole firmament is greater than that portion of it occupied by the full moon. This proportion is nearly that of 300,000 to 1; and hence the light of a cloudy day is 300,000 times brighter than moonlight: consequently, the intensity of the moon's rays is certainly not greater than $\frac{1}{300,000}$ part of the intensity of sunlight. In the experiment of De-la-Hire, just explained, where the moon's rays were concentrated in the proportion of 300 to 1, the effect of the concentrated light in the focus of a burning-glass would not amount to

more than the one thousandth part of the effect of the direct *unconcentrated* light of the sun. Now it was found that, under favorable circumstances, the sunlight, acting on the bulb of a thermometer, caused it to rise about 230° , it follows, therefore, that the effect of the concentrated light of the moon, in the experiment just mentioned, could not exceed the fifth part of a degree; but even this is greater than its true effects, because the light of the moon has been here compared with the light of a cloudy day, which is less intense than the direct rays of the sun. From this and other reasons, it is probable that, admitting the moon's rays to possess the calorific power, they could not, in the experiment of De-la-Hire, affect the thermometer to an extent even of the twentieth of a degree.

There are certain bodies which, at a comparatively low temperature, possess the property of emitting light, presenting an appearance of a lambent flame, the color being different in different bodies, and apparently depending on the color of the body itself; this process is called *phosphorescence*. The minerals which possess this property in the highest degree, are fluorspar and phosphate of lime. Some bodies exhibit this effect at the commencement of spontaneous combustion. Certain kinds of meat and fish, when putrefaction begins, are luminous in the dark. If four drachms of the substance of whiting, herring, or mackerel, be put into a phial containing two ounces of sea-water, or of pure water holding in solution half a drachm of common salt, the phial, when exposed in a dark place, after the lapse of three days, exhibits a luminous ring on the surface of the liquid. The whole liquid, when agitated, becomes luminous, and continues so for some time. When these liquids are frozen, the phosphorescence disappears, but it reappears when they are again thawed. A moderate increase of temperature causes an increase in the luminous appearance, but a boiling heat extinguishes it. The light thus produced has no sensible effect on the thermometer.

ACTION AND REACTION.

Inertia in a single Body.—Consequences of Inertia in two or more Bodies.—Examples.—Effects of Impact.—Motion not estimated by Speed or Velocity alone.—Examples.—Rule for estimating the Quantity of Motion.—Action and Reaction.—Examples of.—Velocity of two Bodies after Impact.—Magnet and Iron.—Feather and Cannon-Ball impinging.—Newton's Laws of Motion.—Inutility of.

THE [illegible]

18 [illegible]
[illegible]
[illegible]
[illegible]

ACTION AND REACTION.

THE effects of inertia or inactivity are such as may be manifested by a single insulated body, without reference to, or connexion with, any other body whatever; they might all be recognised, if there were but one body existing in the universe. There are, however, other important results of this universal property of matter, to the development of which two bodies at least are necessary. If a mass of matter, moving in any direction, encounter another equal mass which is quiescent, the two masses will move together after the impact; but it will be observed, that their speed after the impact will be only half that of the former mass. Thus the body which was moving before the impact loses half its velocity, and that which was quiescent receives exactly the same amount of motion; the one, therefore, receives just so much motion as the other loses, and therefore the actual quantity of motion after the impact is the same as before it.

Again, let A and B be two masses, B being twice that of A. If, as before, A strikes B with a certain velocity, B being previously quiescent, it will be found that the velocity of the combined masses of A and B after the impact will be just one third of the velocity of A before it. Thus, after the impact A loses two thirds of its velocity, and B consisting of two masses, each equal to A, each of these receives one third of A's motion, so that the whole motion received by B is two thirds of the motion of A before impact. By the impact, therefore, as much motion exactly is received by B as is lost by A.

A similar result will be obtained, whatever proportion may subsist between the masses A and B. Suppose B to be ten times A, then the whole motion of A must, after the impact, be distributed among the parts of the united masses A and B; but these united masses are in this case eleven times the mass of A. Now, as they all move with a common motion, it follows that A's former motion must be equally distributed among them, so that each part shall have an eleventh part of it; therefore the velocity after impact will be the eleventh

part of the velocity of A before it. Thus A loses by the impact ten eleventh parts of its motion, which are precisely what B receives.

Again, if the masses of A and B be 5 and 7, then the united mass after impact will be 12. The motion of A before impact will be equally distributed between these 12 parts, so that each part will have a 12th of it; but 5 of these parts belong to the mass A, and 7 to B. Hence, B will receive $\frac{5}{12}$, while A retains $\frac{7}{12}$.

In general, therefore, when a mass, A, in motion impinges on a mass, B, at rest, to find the motion of the united mass after impact, divide the whole motion of A into as many equal parts as there are equal component masses in A and B together, and then B will receive by the impact as many parts of this motion as it has equal component masses.

This is an immediate consequence of the property of inertia. If we were to suppose that, by their mutual impact, A were to give to B either more or less motion than that which it, A, loses, it would necessarily follow that either A or B must have a power of producing or of resisting motion, which would be inconsistent with the quality of inertia already defined: For, if A give to B *more* motion than it loses, all the overplus or excess must be excited in B by the *action* of A; and therefore A is not inactive, but is capable of exciting motion which it does not possess. On the other hand, B cannot receive from A *less* motion than A loses, because then B must be admitted to have the power by its resistance of destroying all the deficiency; a power essentially active, and inconsistent with the quality of inertia.

If we contemplate the effects of impact, which we have now described, as facts ascertained by experiment (which they may be), we may take them as further verification of the universality of the quality of inertia. But, on the other hand, we may view them as phenomena which may certainly be predicted from the previous knowledge of that quality; and this is one of many instances of the advantage which science possesses over knowledge *merely* practical. Having obtained by observation or experience a certain number of simple facts, and thence deduced the general qualities of bodies, we are enabled, by demonstrative reasoning, to discover *other facts* which have never fallen under our observation, or, if so, may have never excited attention. In this way philosophers have discovered certain small motions and slight changes which have taken place among the heavenly bodies, and have directed the attention of astronomical observers to them, instructing them with the greatest precision as to the exact moment of time, and the point of the firmament to which they should direct the telescope, in order to witness the predicted event.

Since, by the quality of inertia, a body can neither generate nor destroy motion, it follows that when two bodies act upon each other, in any way whatever, the total quantity of motion in a given direction, after the action takes place, must be the same as before it, for otherwise some motion would be produced by the action of the bodies, which would contradict the principle that they are inert. The word "action" is here applied, perhaps improperly, but according to the usage of mechanical writers, to express a certain phenomenon or effect. It is, therefore, not to be understood as implying any active principle in the bodies to which it is attributed.

In the cases of collision of which we have spoken, one of the masses, B, was supposed to be quiescent before the impact. We shall now suppose it to be moving in the same direction as A, that is, toward C, but with a less velocity, so that A shall overtake it, and impinge upon it. After the impact, the two masses will move toward C with a common velocity, the amount of which we now propose to determine.

If the masses A and B be equal, then their motions or velocities added together must be the motion of the united mass after impact, since no motion can either be created or destroyed by that event. But as A and B move with a common motion, this sum must be equally distributed between them, and therefore each will move with a velocity equal to half the sum of their velocities before the impact. Thus, if A have the velocity 7, and B have 5, the velocity of the united mass after impact is 6, being the half of 12, the sum of 7 and 5.

If A and B be not equal, suppose them divided into equal component parts, and let A consist of 8, and B of 6, equal masses : let the velocity of A be 17, so that, the motion of each of the 8 parts being 17, the motion of the whole will be 136. In the same manner, let the velocity of B be 10, the motion of each part being 10, the whole motion of the 6 parts will be 60. The sum of the two motions, therefore, toward C is 196; and since none of this can be lost by the impact, nor any motion added to it, this must also be the whole motion of the united masses after impact. Being equally distributed among the 14 component parts of which these united masses consist, each part will have a fourteenth of the whole motion. Hence, 196 being divided by 14, we obtain the quotient 14, which is the velocity with which the whole moves.

In general, therefore, when two masses, moving in the same direction, impinge one upon the other, and, after impact, move together, their common velocity may be determined by the following rule: "Express the masses and velocities by numbers in the usual way, and multiply the numbers expressing the masses by the numbers which express the velocities; the two products thus obtained being added together, and their sum divided by the sum of the numbers expressing the masses, the quotient will be the number expressing the required velocity."

From the preceding details, it appears that *motion* is not adequately estimated by *speed* or *velocity*. For example, a certain mass, A, moving at a determinate rate, has a certain quantity of motion. If another equal mass, B, be added to A, and a similar velocity be given to it, as much more motion will evidently be called into existence. In other words, the *two* equal masses A and B united have *twice* as much motion as the single mass A had when moving alone, and with the same speed. The same reasoning will show that *three* equal masses will, with the same speed, have *three times* the motion of any one of them. In general, therefore, the velocity being the same, the quantity of motion will always be increased or diminished in the same proportion as the mass moved is increased or diminished.

On the other hand, the quantity of motion does not depend on the mass *only*, but also on the speed. If a certain determinate mass move with a certain determinate speed, another equal mass which moves with twice the speed, that is, which moves over twice the space in the same time, will have twice the quantity of motion. In this manner, the mass being the same, the quantity of motion will increase or diminish in the same proportion as the velocity.

The true estimate, then, of the quantity of motion is found by multiplying together the numbers which express the mass and the velocity. Thus, in the example which has been last given of the impact of masses, the quantities of motion before and after impact appear to be as follow:—

Before impact.		After impact.	
Mass of A	8	Mass of A	8
Velocity of A	17	Common velocity	14
Quantity of motion of A	$8 \times 17^*$ or 136	Quantity of motion of A	8×14 or 112
Mass of B	6	Mass of B	6
Velocity of B	10	Common velocity	14
Quantity of motion of B	6×10 or 60	Quantity of motion of B	6×14 or 84

By this calculation it appears that in the impact A has lost a quantity of motion expressed by 24, and that B has received exactly that amount. The effect, therefore, of the impact is a *transfer* of motion from A to B; but no new motion is produced in the direction A C which did not exist before. This is obviously consistent with the property of inertia, and, indeed, an inevitable result of it.

This phenomenon is an example of a law deduced from the property of inertia, and generally expressed thus: "Action and reaction are equal, and in contrary directions." The student must, however, be cautious not to receive these terms in their ordinary acceptation. After the full explanation of inertia, in the lecture on matter and its physical properties, it is, perhaps, scarcely necessary here to repeat that, in the phenomena manifested by the motion of two bodies, there can be neither "action" nor "reaction," properly so called. The bodies are absolutely incapable either of action or resistance. The sense in which these words must be received, as used in the *law*, is merely an expression of the *transfer* of a certain quantity of motion from one body to another, which is called an *action* in the body which loses the motion, and a *reaction* in the body which receives it. The *accession* of motion to the latter is said to proceed from the *action* of the former; and the *loss* of the same motion in the former is ascribed to the *reaction* of the latter. The whole phraseology is, however, most objectionable and unphilosophical, and is calculated to create wrong notions.

The bodies impinging were, in the last case, supposed to move in the same direction. We shall now consider the case in which they move in opposite directions.

First, let the masses A and B be supposed to be equal, and moving in opposite directions with the same velocity. Let C, fig. 1, be the point at which

Fig. 1.

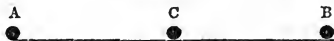

they meet. The equal motions in opposite directions will, in this case, destroy each other, and both masses will be reduced to a state of rest. Thus the mass A loses all its motion in the direction A C, which it may be supposed to transfer to B at the moment of impact. But B, having previously had an equal quantity of motion in the direction B C, will now have two equal motions impressed upon it, in directions immediately opposite; and, these motions neutralizing each other, the mass becomes quiescent. In this case, therefore, as in all the former examples, each body transfers to the other all the motion which it loses, consistently with the principle of "action and reaction."

The masses A and B being still supposed equal, let them move toward C with different velocities. Let A move with the velocity 10, and B with the velocity 6. Of the 10 parts of motion with which A is endued, 6 being transferred to B, will destroy the equal velocity 6, which B has in the direction B C. The bodies will then move together in the direction C B, the four remain-

* The sign \times when placed between two numbers means that they are to be multiplied together.

ing parts of A's motion being equally distributed between them. Each body will, therefore, have two parts of A's original motion, and 2 therefore will be their common velocity after impact. In this case, A loses 8 of the 10 parts of its motion in the direction A C. On the other hand, B loses the entire of its 6 parts of motion in the direction B C, and receives 2 parts in the direction A C. This is equivalent to receiving 8 parts of A's motion in the direction A C. Thus, according to the law of "action and reaction," B receives exactly what A loses.

Finally, suppose that both the masses and velocities of A and B are unequal. Let the mass of A be 8, and its velocity 9; and let the mass of B be 6, and its velocity 5. The quantity of motion of A will be 72, and that of B, in the opposite direction, will be 30. Of the 72 parts of motion which A has in the direction A C, 30, being transferred to B, will destroy all its 30 parts of motion in the direction B C, and the two masses will move in the direction C B, with the remaining 42 parts of motion, which will be equally distributed among their 14 component masses. Each component part will, therefore, receive three parts of motion; and accordingly 3 will be the common velocity of the united mass after impact.

When two masses, moving in opposite directions, impinge and move together, their common velocity after impact may be found by the following rule: "Multiply the numbers expressing the masses by those which express the velocities respectively, and subtract the lesser product from the greater; divide the remainder by the sum of the numbers expressing the masses, and the quotient will be the common velocity; the direction will be that of the mass which has the greater quantity of motion."

It may be shown, without difficulty, that the example which we have just given obeys the law of "action and reaction."

Before impact.		After impact.	
Mass of A	8	Mass of A	8
Velocity of A	9	Common velocity	3
Quantity motion in direction A C	8×9 or 72	Quantity motion in direction A C	8×3 or 24
Mass of B	6	Mass of B	6
Velocity of B	5	Common velocity	3
Quantity motion in direction B C	6×5 or 30	Quantity motion in direction A C	6×3 or 18

Hence it appears that the quantity of motion in the direction A C, of which A has been deprived by the impact, is 48, the difference between 72 and 24. On the other hand, B loses by the impact the quantity 30 in the direction B C, which is equivalent to receiving 30 in the direction A C. But it also acquires a quantity 18 in the direction A C, which, added to the former 30, gives a total of 48 received by B in the direction A C. Thus the same quantity of motion which A loses in the direction A C, is received by B in the same direction. The law of "action and reaction" is, therefore, fulfilled.

The examples of the equality of action and reaction in the collision of bodies may be exhibited experimentally by a very simple apparatus. Let A and B, fig. 2, be two balls of soft clay, or any other substance which is inelastic, or nearly so, and let these be suspended from C by equal strings, so that they may be in contact; and let a graduated arch, of which the centre is C, be placed so that the balls may oscillate over it. One of the balls being moved from its place of rest along the arch, and allowed to descend upon the other through a certain number of degrees, will strike the other with a velocity corresponding to that number of degrees, and both balls will then move together with a velocity which may be estimated by the number of degrees of the arch through which they rise.

In all these cases in which we have explained the law of "action and reac-

tion," the transfer of motion from one body to the other has been made by impact or collision. This phenomenon has been selected only because it is the most ordinary way in which bodies are seen to affect each other. The law is, however, universal, and will be fulfilled in whatever manner the bodies may

Fig. 2.

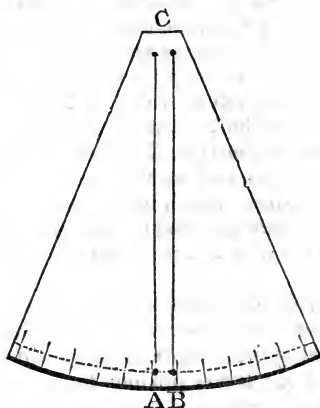

affect each other. Thus A may be connected with B by a flexible string, which, at the commencement of A's motion, is slack. Until the string becomes stretched, that is, until A's distance from B becomes equal to the length of the string, A will continue to have all the motion first impressed upon it. But when the string is stretched, a part of that motion is transferred to B, which is then drawn after A; and whatever motion B in this way receives, A must lose. All that has been observed of the effect of motion transferred by impact will be equally applicable in this case.

Again, if B, fig. 3, be a magnet, moving in the direction B C with a certain quantity of motion, and, while it is so moving, a mass of iron be placed at rest

Fig. 3.

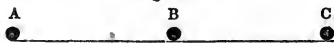

at A, the attraction of the magnet will draw the iron after it toward C, and will thus communicate to the iron a certain quantity of motion in the direction of C. All the motion thus communicated to the iron A must be lost by the magnet B.

If the magnet and the iron were both placed quiescent at B and A, the attraction of the magnet would cause the iron to move from A toward B; but the magnet, in this case, not having any motion, cannot be literally said to *transfer* a motion to the iron. At the moment, however, when the iron begins to move from A toward B, the magnet will be observed to begin also to move from B toward A; and if the velocities of the two bodies be expressed by numbers, and respectively multiplied by the numbers expressing their masses, the quantities of motion thus obtained will be found to be exactly equal. We have already explained why a quantity of motion received in the direction B A is equivalent to the same quantity lost in the direction A B. Hence it appears that the magnet, in receiving as much motion in the direction B A as it gives in the direction A B, suffers an effect which is equivalent to losing as much motion directed toward C as it has communicated to the iron in the same direction.

In the same manner, if the body B had any property in virtue of which it might *repel* A, it would itself be repelled with the same quantity of motion. In

a word, whatever be the manner in which the bodies may affect each other, whether by collision, traction, attraction, or repulsion, or by whatever other name the phenomenon may be designated, still it is an inevitable consequence, that any motion, in a given direction, which one of the bodies may receive, must be accompanied by a loss of motion in the same direction, and to the same amount, by the other body, or the acquisition of as much motion in the contrary direction; or, finally, by a loss in the same direction, and an acquisition of motion in the contrary direction, the combined amount of which is equal to the motion received by the former.

From the principle, that the force of a body in motion depends on the mass and the velocity, it follows that any body, however small, may be made to move with the same force as any other body, however great, by giving to the smaller body a velocity which bears to that of the greater the same proportion as the mass of the greater bears to the mass of the smaller. Thus a feather, ten thousand of which would have the same weight as a cannon-ball, would move with the same force if it had ten thousand times the velocity; and, in such a case, these two bodies, encountering in opposite directions, would mutually destroy each other's motion.

The consequences of the property of inertia, which have been explained in the present and previous lecture, have been given by Newton in his *Principia*, and, after him, in most English treatises on mechanics, under the form of three propositions, which are called the "laws of motion." They are as follow:—

I.

"Every body must persevere in its state of rest, or of uniform motion in a straight line, unless it be compelled to change that state by forces impressed upon it."

II.

"Every change of motion must be proportional to the impressed force, and must be in the direction of that straight line in which the force is impressed."

III.

"Action must always be equal, and contrary to reaction; or the actions of two bodies upon each other must be equal, and directed toward contrary sides."

When *inertia* and *force* are defined, the first law becomes an identical proposition. The second law cannot be rendered perfectly intelligible until the student has read the discourse on the composition and resolution of forces; for, in fact, it is intended as an expression of the whole body of results in that discourse. The third law has been explained in the present lecture, as far as it can be rendered intelligible in the present stage of our progress.

We have noticed these formularies more from a respect for the authorities by which they have been adopted, than from any persuasion of their utility. Their full import cannot be comprehended until nearly the whole of elementary mechanics has been acquired, and then all such summaries become useless.

The consequences deduced from the consideration of the quality of inertia in this lecture, will account for many effects which fall under our notice daily, and with which we have become so familiar that they have almost ceased to excite curiosity. One of the facts of which we have most frequent practical illustration is, that the quantity of motion, or *moving force*, as it is sometimes called, is estimated by the velocity of the motion and the weight or mass of the thing moved conjointly.

If the same force impel two balls, one of one pound weight, and the other of two pounds, it follows, since the balls can neither give force to themselves nor

resist that which is impressed upon them, that they will move with the same force. But the lighter ball will move with twice the speed of the heavier. The impressed force which is manifested by giving velocity to a double mass in the one, is engaged in giving a double velocity to the other.

If a cannon-ball were forty times the weight of a musket-ball, but the musket-ball moved with forty times the velocity of the cannon-ball, both would strike any obstacle with the same force and would overcome the same resistance; for the one would acquire from its velocity as much force as the other derives from its weight.

A very small velocity may be accompanied by enormous force, if the mass which is moved with that velocity be proportionally great. A large ship floating near the pier-wall may approach it with so small a velocity as to be scarcely perceptible, and yet the force will be so great as to crush a small boat.

A grain of shot, flung from the hand and striking the person, will occasion no pain, and, indeed, will scarcely be felt, while a block of stone having the same velocity would occasion death.

If a body in motion strike a body at rest, the striking body must sustain as great a shock from the collision as if it had been at rest and struck by the other body with the same force; for the loss of force which it sustains in the one direction is an effect of the same kind as if, being at rest, it had received as much force in the opposite direction. If a man, walking rapidly, or running, encounters another standing still, he suffers as much from the collision as the man against whom he strikes.

If a leaden bullet be discharged against a plank of hard wood, it will be found that the round shape of the ball is destroyed, and that it has itself suffered a force by the impact, which is equivalent to the effect which it produces upon the plank.

When two bodies moving in opposite directions meet, each body sustains as great a shock as if, being at rest, it had been struck by the other body with the united forces of the two. Thus, if two equal balls, moving at the rate of ten feet in a second, meet, each will be struck with the same force as if, being at rest, the other had moved against it at the rate of twenty feet in a second. In this case, one part of the shock sustained arises from the loss of force in one direction, and another from the reception of force in the opposite direction.

For this reason, two persons walking in opposite directions receive from their encounter a more violent shock than might be expected. If they be of nearly equal weight, and one be walking at the rate of three, and the other four miles an hour, each sustains the same shock as if he had been at rest, and struck by the other running at the rate of seven miles an hour.

This principle accounts for the destructive effects arising from ships running foul of each other at sea. If two ships of 500 tons burden encounter each other, sailing at ten knots an hour, each sustains the shock which, being at rest, it would receive from a vessel of 1,000 tons burden sailing ten knots an hour.

It is a mistake to suppose that, when a large and small body encounter, the small body suffers a greater shock than the large one. The shock which they sustain must be the same; but the large body may be better able to bear it.

When the fist of a pugilist strikes the body of his antagonist, it sustains as great a shock as it gives; but the part being more fitted to endure the blow, the injury and pain are inflicted on his opponent. This is not the case, however, when fist meets fist. Then the parts in collision are equally sensitive and vulnerable, and the effect is aggravated by both having approached each other with great force. The effect of the blow is the same as if one fist, being held at rest, were struck by the other with the combined force of both.

COMPOSITION & RESOLUTION OF FORCE.

Motion and Pressure.—Force.—Attraction.—Parallelogram of Forces.—Resultant.—Components.—Composition of Force.—Resolution of Force.—Illustrative Experiments.—Composition of Pressures.—Theorems regulating Pressures also regulate Motion.—Examples.—Resolution of Motion.—Forces in Equilibrium.—Composition of Motion and Pressure.—Illustrations.—Boat in a Current.—Motions of Fishes.—Flight of Birds.—Sails of a Vessel.—Tacking.—Equestrian Feats.—Absolute and relative Motion.

THE HISTORY OF THE

ROYAL SOCIETY OF LONDON

FROM ITS INSTITUTION

TO THE PRESENT TIME

BY

JOHN VAN DER HAEGHE

ESQ.

OF

THE UNIVERSITY OF TORONTO

AND

OF THE

ROYAL SOCIETY OF LONDON

COMPOSITION & RESOLUTION OF FORCE.

MOTION and pressure are terms too familiar to need explanation. It may be observed, generally, that definitions in the first rudiments of a science are seldom, if ever, comprehended. The force of words is learned by their application; and it is not until a definition becomes useless, that we are taught the meaning of the terms in which it is expressed. Moreover, we are perhaps justified in saying that, in the mathematical sciences, the fundamental notions are of so uncompounded a character, that definitions, when developed and enlarged upon, often draw us into metaphysical subtleties and distinctions, which, whatever be their merit or importance, would be here altogether misplaced. We shall, therefore, at once take it for granted, that the words *motion* and *pressure* express phenomena or effects which are the subjects of constant experience and hourly observation; and if the scientific use of these words be more precise than their general and popular application, that precision will soon be learned by their frequent use in the present treatise.

Force is the name given in mechanics to whatever produces motion or pressure. This word is also often used to express the motion or pressure itself; and when the cause of the motion or pressure is not known, this is the only correct use of the word. Thus, when a piece of iron moves toward a magnet, it is usual to say that the cause of the motion is "the attraction of the magnet;" but in effect we are ignorant of the *cause* of this phenomenon, and the name *attraction* would be better applied to the effect, of which we have experience. In like manner the *attraction* and *repulsion* of electrified bodies should be understood, not as names for unknown causes, but as words expressing observed appearances or effects.

When a certain phraseology has, however, gotten into general use, it is neither easy nor convenient to supersede it. We shall, therefore, be compelled, in speaking of motion or pressure, to use the language of causation; but must advise the student that it is effects, and not causes, which will be expressed.

If two forces act upon the same point of a body in different directions, a sin-

gle force may be assigned, which, acting on that point, will produce the same result as the united effects of the other two.

Let P , fig. 1, be the point on which the two forces act, and let their directions be PA and PB . From the point P , upon the line PA , take a length

Fig. 1.

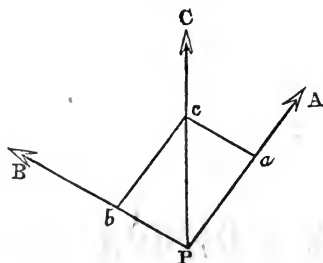

Pa , consisting of as many inches as there are ounces in the force PA ; and, in like manner, take Pb , in the direction PB , consisting of as many inches as there are ounces in the force PB . Through a draw a line parallel to PB , and through b draw a line parallel to PA , and suppose these lines meet at c . Then draw Pc . A single force, acting in the direction Pc , and consisting of as many ounces as the line Pc consists of inches, will produce upon the point P the same effect as the two forces PA and PB produce acting together.

The figure $Pa cb$ is called, in geometry, a *parallelogram*; the lines Pa , Pb , are called its *sides*, and the line Pc is called its *diagonal*. Thus the method of finding an equivalent for two forces, which we have just explained, is generally called "the parallelogram of forces," and is usually expressed thus: "If two forces be represented in quantity and direction by the sides of a parallelogram, an equivalent force will be represented in quantity and direction by its diagonal."

A single force, which is thus mechanically equivalent to two or more other forces, is called their *resultant*, and relatively to it they are called its *components*. In any mechanical investigation, when the result is used for the components, which it always may be, the process is called "the composition of force." It is, however, frequently expedient to substitute for a single force two or more forces, to which it is mechanically equivalent, or of which it is the resultant. This process is called "the resolution of force."

To verify experimentally the theorem of the parallelogram of forces is not difficult. Let two small wheels, $M N$, fig. 2, with grooves in their edges to receive a thread, be attached to an upright board, or to a wall. Let a thread be passed over them, having weights, A and B , hooked upon loops at its extremities. From any part, P , of the thread between the wheels let a weight, C , be suspended; it will draw the thread downward, so as to form an angle, $M P N$, and the apparatus will settle itself at rest in some determinate position. In this state it is evident that, since the weight C , acting in the direction PC , balances the weights A and B , acting in the directions PM and PN , these two forces must be mechanically equivalent to a force equal to the weight C , and acting directly upward from P . The weight C is therefore the quantity of the resultant of the forces PM and PN ; and the direction of the resultant is that of a line drawn directly upward from P .

To ascertain how far this is consistent with the theorem of "the parallelo-

gram of forces," let a line, $P O$, be drawn upon the upright board to which the wheels are attached, from the point P upward, in the direction of the thread $C P$. Also, let lines be drawn upon the board immediately under the threads

Fig. 2.

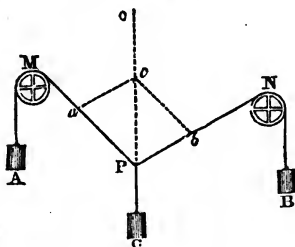

$P M$ and $P N$. From the point P , on the line $P O$, take as many inches as there are ounces in the weight C . Let the part of $P O$ thus measured be $P c$, and from c draw $c a$ parallel to $P N$, and $c b$ parallel to $P M$. If the sides $P a$ and $P b$ of the parallelogram thus formed be measured, it will be found that $P a$ will consist of as many inches as there are ounces in the weight A , and $P b$ of as many inches as there are ounces in the weight B .

In this illustration, *ounces* and *inches* have been used as the subdivisions of *weight* and *length*. It is scarcely necessary to state, that any other measures of these quantities would serve as well, only observing that the same denominations must be preserved in all parts of the same investigation.

Among the philosophical apparatus of the University of London, is a very simple and convenient instrument which I have constructed for the experimental illustration of this important theorem. The wheels $M N$ are attached to the tops of two tall stands, the heights of which may be varied at pleasure by an adjusting screw. A jointed parallelogram, $A B C D$, fig. 3, is formed, whose

Fig. 3.

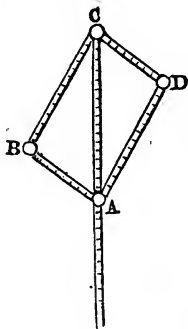

sides are divided into inches, and the joints at A and B are moveable, so as to vary the lengths of the sides at pleasure. The joint C is fixed at the extremity of a ruler, also divided into inches, while the opposite joint A is attached to a brass loop, which surrounds the diagonal ruler loosely, so as to slide freely along it. An adjusting screw is provided in this loop, so as to clamp it in any required position.

In making the experiment, the sides AB and AD , CB and CD , are adjusted by the joints B and A to the same number of inches respectively as there are ounces in the weights A and B , fig. 2. Then the diagonal AC is adjusted by the loop and screw at A , to as many inches as there are ounces in the weight C . This done, the point A is placed behind P , fig. 2, and the parallelogram is held upright, so that the diagonal AC shall be in the direction of the vertical thread PC . The sides AB and AD will then be found to take the direction of the threads PM and PN . By changing the weights and the lengths of the diagonal and sides of the parallelogram, the experiment may be easily varied at pleasure.

In the examples of the composition of forces which we have here given, the effects of the forces are the production of pressures; or, to speak more correctly, the theorem which we have illustrated is "the composition of pressures." For the point P is supposed to be at rest, and to be drawn or pressed in the directions PM and PN . In the definition which has been given of the word *force*, it is declared to include motions as well as pressures. In fact, if motion be resisted, the effect is converted into pressure. The same cause, acting upon a body, will either produce motion or pressure, according as the body is free or restrained. If the body be free, motion ensues; if restrained, pressure, or both these effects together. It is, therefore, consistent with analogy to expect that the same theorems which regulate pressures will also be applicable to motions, and we find accordingly a most exact correspondence.

If a body have a motion in the direction AB , and at the point P it receive another motion, such as would carry it in the direction PC , fig. 4, were it pre-

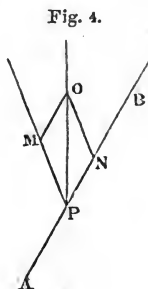

viously quiescent at P , it is required to determine the direction which the body will take, and the speed with which it will move, under these circumstances.

Let the velocity with which the body is moving from A to B be such, that it would move through a certain space, suppose PN , in one second of time, and let the velocity of the motion impressed upon it at P be such, that, if it had no previous motion, it would move from P to M in one second. From the point M draw a line parallel to PB , and from N draw a line parallel to PC , and suppose these lines to meet at some point, as O . Then draw the line PO . In consequence of the two motions, which are at the same time impressed upon the body at P , it will move in the straight line from P to O .

Thus the two motions, which are expressed in quantity and direction by the sides of a parallelogram, will, when given to the same body, produce a single motion, expressed in quantity and direction by its diagonal; a theorem which is to motions exactly what the former was to pressures.

There are various methods of illustrating experimentally the composition of

motion. An ivory ball, being placed upon a perfectly level, square table, at one of the corners, and receiving two equal impulses, in the directions of the sides of the table, will move along the diagonal. Apparatus for this experiment differ from each other only in the way of communicating the impulses to the ball.

As two motions simultaneously communicated to a body are equivalent to a single motion in an intermediate direction, so also a single motion may be mechanically replaced by two motions in directions expressed by the sides of any parallelogram, whose diagonal represents the single motion. This process is "the resolution of motion," and gives considerable clearness and facility to many mechanical investigations.

It is frequently necessary to express the portion of a given force, which acts in some given direction different from the immediate direction of the force itself. Thus, if a force act from A, fig. 5, in the direction A C, we may require

Fig. 5.

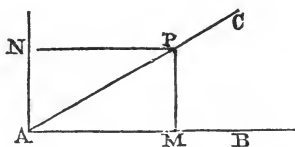

to estimate what part of that force acts in the direction A B. If the force be a pressure, take as many inches, A P, from A, on the line A C, as there are ounces in the force, and from P draw P M perpendicular to A B; then the part of the force which acts along A B will be as many ounces as there are inches in A M. The force A B is mechanically equivalent to two forces, expressed by the sides A M and A N of the parallelogram; but A N, being perpendicular to A B, can have no effect on a body at A, in the direction of A B, and therefore the effective part of the force A P, in the direction A B, is expressed by A M.

Any number of forces acting on the same point of a body may be replaced by a single force which is mechanically equivalent to them, and which is, therefore, their resultant. This composition may be effected by the successive application of the parallelogram of forces. Let the several forces be called A, B, C, D, E, &c. Draw the parallelogram whose sides express the forces A and B, and let its diagonal be A'. The force expressed by A' will be equivalent to A and B. Then draw the parallelogram whose sides express the forces A' and C, and let its diagonal be B'. This diagonal will express a force mechanically equivalent to A' and C. But A' is mechanically equivalent to A and B, and therefore B' is mechanically equivalent to A, B, and C. Next construct a parallelogram whose sides express the forces B' and D, and let its diagonal be C'. The force expressed by C' will be mechanically equivalent to the forces B' and D; but the force B' is equivalent to A, B, C, and therefore C' is equivalent to A, B, C, and D. By continuing this process, it is evident that a single force may be found which will be equivalent to, and may be always substituted for, any number of forces which act upon the same point.

If the forces which act upon the point neutralize each other, so that no motion can ensue, they are said to be in equilibrium.

Examples of the composition of motion and pressure are continually presenting themselves. They occur in almost every instance of motion or force which falls under our observation. The difficulty is to find an example which, strictly speaking, is a simple motion.

When a boat is rowed across a river, in which there is a current, it will not move in the direction in which it is impelled by the oars. Neither will it take the direction of the stream, but will proceed exactly in that intermediate direction which is determined by the composition of force.

Let A, fig. 6, be the place of the boat at starting; and suppose that the oars are so worked as to impel the boat toward B with a force which would carry it to B in one hour, if there were no current in the river. But, on the other

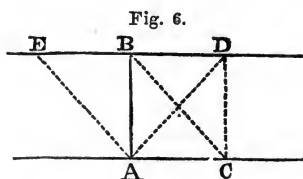

hand, suppose the rapidity of the current is such that, without any exertion of the rowers, the boat would float down the stream in one hour to C. From C draw C D parallel to A B, and draw the straight line A D diagonally. The combined effect of the oars and the current will be, that the boat will be carried along A D, and will arrive at the opposite bank in one hour, at the point D.

If the object be, therefore, to reach the point B, starting from A, the rowers must calculate, as nearly as possible, the velocity of the current. They must imagine a certain point, E, at such a distance above B that the boat would be floated by the stream from E to B in the time taken in crossing the river in the direction A E, if there were no current. If they row toward the point E, the boat will arrive at the point B, moving in the line A B.

In this case the boat is impelled by two forces, that of the oars in the direction A E, and that of the current in the direction A C. The result will be, according to the parallelogram of forces, a motion in the diagonal A B.

The wind and tide acting upon a vessel is a case of a similar kind. Suppose that the wind is made to impel the vessel in the direction of the keel,

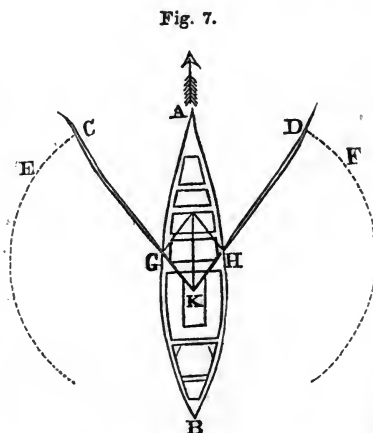

while the tide may be acting in any direction oblique to that of the keel. The course of the vessel is determined exactly in the same manner as that of the boat in the last example.

The action of the oars themselves, in impelling the boat, is an example of the composition of force. Let A, fig. 7, be the head, and B the stern of the boat. The boatman presents his face toward B, and places the oars so that their blades press against the water in the directions C E, D F. The resistance of the water produces forces on the side of the boat, in the directions G L and H L, which, by the composition of force, are equivalent to the diagonal force K L, in the direction of the keel.

Similar observations will apply to almost every body impelled by instruments projecting from its sides and acting against a fluid. The motions of fishes, the act of swimming, the flight of birds, are all instances of the same kind.

The action of wind upon the sails of a vessel, and the force thereby transmitted to the keel, modified by the rudder, is a problem which is solved by the principles of the composition and resolution of force; but it is of too complicated and difficult a nature to be introduced with all its necessary conditions and limitations in this place. The question may, however, be simplified, if we consider the canvass of the sails to be stretched so completely as to form a plane surface. Let A B, fig. 8, be the position of the sail, and let the wind

Fig. 8.

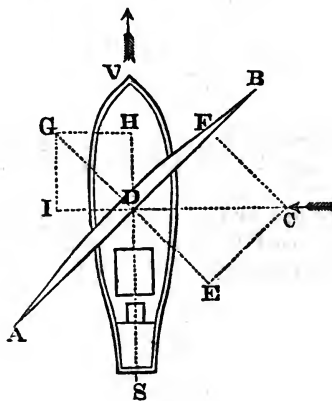

blow in the direction C D. If the line C D be taken to express the force of the wind, let D E C F be a parallelogram, of which it is the diagonal. The force C D is equivalent to two forces, one in the direction F D of the plane of the canvass, and the other E D perpendicular to the sail. The effect, therefore, is the same as if there were *two winds*, one blowing in the direction of F D or B A, that is, against the edge of the sail, and the other, E D, blowing full against its face. It is evident that the former will produce no effect whatever upon the sail, and that the latter will urge the vessel in the direction D G.

Let us now consider this force D G as acting in the diagonal of the parallelogram D H G I. It will be equivalent to two forces, D H and D I, acting along the sides. One of these forces, D H, is in the direction of the keel, and the other, D I, at right angles to the length of the vessel, so as to urge it *side-wise*. The form of the vessel is evidently such as to offer a great resistance to the latter force, and very little to the former. It consequently proceeds with considerable velocity in the direction D H of its keel, and makes way very slowly in the sideward direction D I. The latter effect is called *leeway*.

From this explanation, it will be easily understood how a wind which is

nearly opposed to the course of a vessel may, nevertheless, be made to impel it by the effect of sails. The angle $B D V$, formed by the sail and the direction of the keel, may be very oblique, as may also be the angle $C D B$, formed by the direction of the wind and that of the sail. Therefore the angle $C D V$, made up of these two, and which is that formed by the direction of the wind and that of the keel, may be very oblique. In fig. 9, the wind is nearly contrary

Fig. 9.

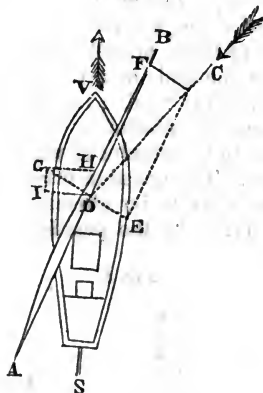

to the direction of the keel, and yet there is an impelling force expressed by the line $D H$, the line $C D$ expressing, as before, the whole force of the wind.

In this example there are two successive decompositions of force. First, the original force of the wind $C D$ is resolved into two, $E D$ and $F D$; and next the element $E D$, or its equal $D G$, is resolved into $D I$ and $D H$; so

Fig. 10.



that the original force is resolved into three, viz., $F D$, $D I$, $D H$, which, taken together, are mechanically equivalent to it. The part $F D$ is entirely ineffec-

ual; it glides off on the surface of the canvass without producing any effect upon the vessel. The part D I produces *leeway*, and the part D H impels.

If the wind, however, be directly contrary to the course which it is required that the vessel should take, there is no position which can be given to the sails which will impel the vessel. In this case, the required course itself is resolved into two, in which the vessel sails alternately, a process which is called *tacking*. Thus, suppose the vessel is required to move from A to E, fig. 10, the wind setting from E to A. The motion A B being resolved into two, by being assumed as the diagonal of a parallelogram, the sides A a, a B, of the parallelogram are successively sailed over, and the vessel by this means arrives at B, instead of moving along the diagonal A B. In the same manner she moves along B b, b C, C c, c D, D d, d E, and arrives at E. She thus sails continually at a sufficient angle with the wind to obtain an impelling force, yet at a sufficiently small angle to make way in her proposed course.

The consideration of the effect of the rudder, which we have omitted in the preceding illustration, affords another instance of the resolution of force. We shall not, however, pursue this example further.

A body falling from the top of the mast, when the vessel is in full sail, is an example of the composition of motion. It might be expected that, during the descent of the body, the vessel, having sailed forward, would leave it behind, and that, therefore, it would fall in the water behind the stern, or at least on the deck, considerably behind the mast. On the other hand, it is found to fall at the foot of the mast, exactly as it would if the vessel were not in motion. To account for this, let A B, fig. 11, be the position of the mast when the body

Fig. 11.



Fig. 12.

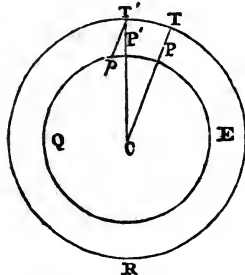

at the top is disengaged. The mast is moving onward with the vessel in the direction A C, so that in the time which the body would take to fall to the deck the top of the mast would move from A to C. But the body, being on the mast at the moment it is disengaged, has this motion A C in common with the mast, and, therefore, in its descent it is affected by two motions, viz., that of the vessel expressed by A C, and its descending motion expressed by A B. Hence, by the composition of motion, it will be found at the opposite angle, D, of the parallelogram, at the end of the fall. During the fall, however, the mast has moved with the vessel, and has advanced to C D, so that the body falls at the foot of the mast.

An instance of the composition of motion, which is worthy of some attention, as it affords a proof of the diurnal motion of the earth, is derived from observing the descent of a body from a very high tower. To render the explanation of this more simple, we shall suppose the tower to be on the equator of the earth. Let E P Q, fig. 12, be a section of the earth through the equator, and let P T be the tower. Let us suppose that the earth moves on its axis in the

direction $E P Q$. The foot P of the tower will, therefore, in one day, move over the circle $E P Q$, while the top T moves over the greater circle $T' T' R$. Hence it is evident that the top of the tower moves with greater speed than the foot, and therefore in the same time moves through a greater space. Now suppose a body placed at the top; it participates in the motion which the top of the tower has in common with the earth. If it be disengaged, it also receives the descending motion $T P$. Let us suppose that the body would take five seconds to fall from T to P , and that in the same time the top T is moved by the rotation of the earth from T to T' , the foot being moved from P to P' . The falling body is therefore endued with two motions, one expressed by $T T'$, and the other by $T P$. The combined effect of these will be found in the usual way by the parallelogram. Take $T p$, equal to $T T'$, the body will move from T to p in the time of the fall, and will meet the ground at p . But since $T T'$ is greater than $P P'$, it follows that p must be at a distance from P' equal to the excess of $T T'$ above $P P'$. Hence the body will not fall exactly at the foot of the tower, but at a certain distance from it, in the direction of the earth's motion, that is, eastward. This is found, by experiment, to be actually the case; and the distance from the foot of the tower, at which the body is observed to fall, agrees with that which is computed from the motion of the earth, to as great a degree of exactness as could be expected from the nature of the experiment.

The properties of compounded motions cause some of the equestrian feats exhibited at public spectacles to be performed by a kind of exertion very different from that the spectators generally attribute to the performer. For example, the horseman, standing on the saddle, leaps over a garter extended over the horse at right angles to his motion; the horse passing under the garter, the rider lights upon the saddle at the opposite side. The exertion of the performer, in this case, is not that which he would use were he to leap from the ground over a garter at the same height. In the latter case, he would make an exertion to rise, and at the same time to project his body forward. In the case, however, of the horseman, he merely makes that exertion which is necessary to rise directly upward to a sufficient height to clear the garter. The motion which he has in common with the horse, compounded with the elevation acquired by his muscular power, accomplishes the leap.

To explain this more fully, let $A B C$, fig. 13, be the direction in which the

Fig. 13.

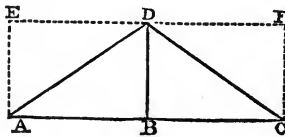

horse moves, A being the point at which the rider quits the saddle, and C the point at which he returns to it. Let D be the highest point which is to be cleared in the leap. At A the rider makes a leap toward the point E , and this must be done at such a distance from B , that he would rise from B to E in the time in which the horse moves from A to B . On departing from A , the rider has, therefore, two motions, represented by the lines $A E$ and $A B$, by which he will move from the point A to the opposite angle, D , of the parallelogram. At D , the exertion of the leap being overcome by the weight of his body, he begins to return downward, and would fall from D to B in the time in which the horse moves from B to C . But at D he still retains the motion which he

had in common with the horse, and therefore, in leaving the point D, he has two motions, expressed by the lines D F and D B. The compounded effects of these motions carry him from D to C. Strictly speaking, his motion from A to D, and from D to C, is not in straight lines, but in a curve. It is not necessary here, however, to attend to this circumstance.

If a billiard-ball strike the cushion of the table obliquely, it will be reflected from it in a certain direction, forming an angle with the direction in which it struck it. This affords an example of the resolution and composition of motion. We shall first consider the effect which would ensue if the ball struck the cushion perpendicularly.

Let A B, fig. 14, be the cushion, and C D the direction in which the ball

Fig. 14.

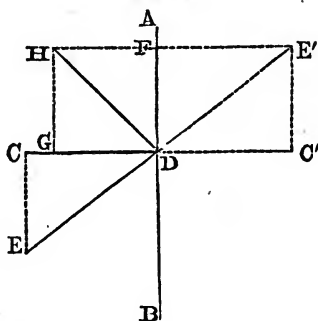

moves toward it. If the ball and the cushion were perfectly inelastic, the resistance of the cushion would destroy the motion of the ball, and it would be reduced to a state of rest at D. If, on the other hand, the ball were perfectly elastic, it would be reflected from the cushion, and would receive as much motion from D to C, after the impact, as it had from C to D before it. Perfect elasticity, however, is a quality which is never found in these bodies. They are always elastic, but imperfectly so. Consequently the ball, after the impact, will be reflected from D toward C, but with a less motion than that with which it approached from C to D.

Now let us suppose that the ball, instead of moving from C to D, moves from E to D. The force with which it strikes D, being expressed by D E', equal to E D, may be resolved into two, D F and D C'. The resistance of the cushion destroys D C', and the elasticity produces a contrary force in the direction D C, but less than D C or D C', because that elasticity is imperfect. The line D C expressing the force in the direction C D, let D G (less than D C) express the reflective force in the direction D C. The other element, D F, into which the force D E' is resolved by the impact, is not destroyed or modified by the cushion, and therefore, on leaving the cushion at D, the ball is influenced by two forces, D F (which is equal to C E) and D G. Consequently it will move in the diagonal D H.

The angle E D C is, in this case, called the "angle of incidence," and C D H is called the "angle of reflection." It is evident, from what has just been inferred, that, the ball being imperfectly elastic, the angle of incidence must always be less than the angle of reflection, and, with the same obliquity of incidence, the more imperfect the elasticity is, the less will be the angle of reflection.

In the impact of a perfectly elastic body, the angle of reflection would be equal to the angle of incidence. For then the line D G, expressing the reflec-

tive force, would be taken equal to $C D$, and the angle $C D H$ would be equal to $C D E$. This is found by experiment to be the case when light is reflected from a polished surface of glass or metal.

Motion is sometimes distinguished into *absolute* and *relative*. What "relative motion" means is easily explained. If a man walk upon the deck of a ship from stem to stern, he has a relative motion which is measured by the space upon the deck over which he walks in a given time. But while he is thus walking from stem to stern, the ship and its contents, including himself, are impelled through the deep in the opposite direction. If it so happen that the motion of the man from stem to stern be exactly equal to the motion of the ship in the contrary way, the man will be, relatively to the surface of the sea and that of the earth, at rest. Thus, relatively to the ship, he is in motion, while, relatively to the surface of the earth, he is at rest. But still this is not absolute rest. The surface itself is moving by the diurnal rotation of the earth upon its axis, as well as by the annual motion in its orbit round the sun. These motions, and others to which the earth is subject, must be all compounded by the theorem of the parallelogram of forces, before we can obtain the *absolute state* of the body with respect to motion or rest.

CENTRE OF GRAVITY.

Terrestrial Attraction the combined Action of parallel Forces.—Single equivalent Force.—Examples.—Method of finding the Centre of Gravity.—Line of Direction.—Globe.—Oblate Spheroid.—Prolate Spheroid.—Cube.—Straight Wand.—Flat Plate.—Triangular Plate.—Centre of Gravity not always within the Body.—A Ring.—Experiments.—Stable, instable, and neutral Equilibrium.—Motion and Position of the Arms and Feet.—Effect of the Knee-Joint.—Positions of a Dancer.—Porter under a Load.—Motion of a Quadruped.—Rope Dancing.—Centre of Gravity of two Bodies separated from each other.—Mathematical and experimental Examples.—The Conservation of the Motion of the Centre of Gravity.—Solar System.—Centre of Gravity sometimes called Centre of Inertia.

1875

1875
1876
1877
1878
1879
1880
1881
1882
1883
1884
1885
1886
1887
1888
1889
1890
1891
1892
1893
1894
1895
1896
1897
1898
1899
1900

CENTRE OF GRAVITY.

By the earth's attraction, all the particles which compose the mass of a body are solicited by equal forces in parallel directions downward. If these component particles were placed in mere juxtaposition, without any mechanical connexion, the force impressed on any one of them could in nowise affect the others, and the mass would in such a case be contemplated as an aggregation of small particles of matter, each urged by an independent force. But the bodies which are the subjects of investigation in mechanical science are not found in this state. Solid bodies are coherent masses, the particles of which are firmly bound together, so that any force which affects one, being modified according to circumstances, will be transmitted through the whole body. Liquids accommodate themselves to the shape of the surfaces on which they rest, and forces affecting any one part are transmitted to others, in a manner depending on the peculiar properties of this class of bodies.

As all bodies, which are subjects of mechanical inquiry, on the surface of the earth, must be continually influenced by terrestrial gravity, it is desirable to obtain some easy and summary method of estimating the effect of this force. To consider it, as is unavoidable in the first instance, the combined action of an infinite number of equal and parallel forces soliciting the elementary molecules downward, would be attended with manifest inconvenience. An infinite number of forces, and an infinite subdivision of the mass, would form parts of every mechanical problem.

To overcome this difficulty, and to obtain all the ease and simplicity which can be desired in elementary investigations, it is only necessary to determine some force, whose single effect shall be equivalent to the combined effects of the gravitation of all the molecules of the body. If this can be accomplished, that single force might be introduced into all problems to represent the whole effect of the earth's attraction, and no regard need be had to any particles of the body, except that on which this force acts.

To discover such a force, if it exist, we shall first inquire what properties

Fig. 1.

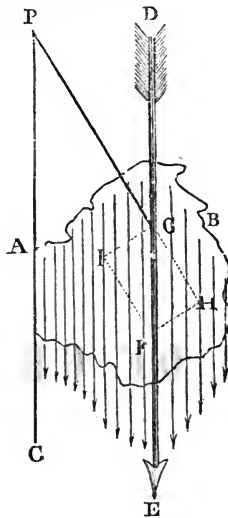

must necessarily characterize it. Let *AB*, fig. 1, be a solid body placed near the surface of the earth. Its particles are all solicited downward, in the directions represented by the arrows. Now, if there be any single force equivalent to these combined effects, two properties may be at once assigned to it: 1, it must be presented downward, in the common direction of those forces to which it is mechanically equivalent; and, 2, it must be equal in intensity to their sum, or, what is the same, to the force with which the whole mass would descend. We shall then suppose it to have this intensity, and to have the direction of the arrow *DE*. Now, if the single force, in the direction *DE*, be equivalent to all the separate attractions which affect the particles, we may suppose all these attractions removed, and the body *AB* influenced only by a single attraction, acting in the direction *DE*. This being admitted, it follows that if the body be placed on a prop, immediately under the direction of the line *DE*, or be suspended from a fixed point immediately above its direction, it will remain motionless. For the whole attracting force in the direction *DE* will, in the one case, press the body on the prop, and, in the other case, will give tension to the cord, rod, or whatever other means of suspension be used.

But suppose the body were suspended from some point *P*, not in the direction of the line *DE*. Let *PC* be the direction of the thread by which the body is suspended. Its whole weight, according to the supposition which we have adopted, must then act in the direction *CE*. Taking *CF* to represent the weight, it may be considered as mechanically equivalent to two forces (74), *CI* and *CH*. Of these, *CH*, acting directly from the point *P*, merely produces pressure upon it, and gives tension to the cord *PC*; but *CI*, acting at right angles to *CP*, produces motion round *P* as a centre, and in the direction *CI*, toward a vertical line *PG*, drawn through the point *P*. If the body *AB* had been on the other side of the line *PG*, it would have moved, in like manner, toward it, and therefore in the direction contrary to its present motion.

Hence we must infer, that, when the body is suspended from a fixed point, it cannot remain at rest, if that fixed point be not placed in the direction of the line *DE*; and, on the other hand, that if the fixed point be in the direction of that line, it cannot move. A practical test is thus suggested, by which the

line D E may be at once discovered. Let a thread be attached to any point of the body, and let it be suspended by this thread from a hook or other fixed point. The direction of the thread, when the body becomes quiescent, will be that of a single force equivalent to the gravitation of all the component parts of the mass.

An inquiry is here suggested: Does the direction of the equivalent force, thus determined, depend on the position of the body with respect to the surface of the earth, and how is the direction of the equivalent force affected by a change in that position? This question may be at once solved if the body be suspended by different points, and the directions which the suspending thread takes in each case relatively to the figure and dimensions of the body examined.

The body being suspended in this manner from any point, let a small hole be bored through it, in the exact direction of the thread, so that if the thread were continued below the point where it is attached to the body, it would pass through this hole. The body being successively suspended by several different points on its surface, let as many small holes be bored through it in the same manner. If the body be then cut through, so as to discover the directions which the several holes have taken, they will be all found to cross each other at one point within the body; or the same fact may be discovered thus: a thin wire, which nearly fills the holes, being passed through any one of them, it will be found to intercept the passage of a similar wire through any other.

This singular fact teaches us—what, indeed, can be proved by mathematical reasoning without experiment—that there is *one* point in every body through which the single force, which is equivalent to the gravitation of all its particles, must pass in whatever position the body be placed. This point is called *the centre of gravity*.

In whatever situation a body may be placed, the centre of gravity will have a tendency to descend in the direction of a line perpendicular to the horizon, and which is called *the line of direction* of the weight. If the body be altogether free and unrestricted by any resistance or impediment, the centre of gravity will actually descend in this direction, and all the other points of the body will move with the same velocity in parallel directions, so that, during its fall, the position of the parts of the body with respect to the ground will be unaltered. But if the body, as is most usual, be subject to some resistance or restraint, it will either remain unmoved, its weight being expended in exciting pressure on the restraining points or surfaces, or it will move in a direction and with a velocity depending on the circumstances which restrain it.

In order to determine these effects—to predict the pressure produced by the weight if the body be quiescent, or the mixed effects of motion and pressure if it be not so—it is necessary in all cases to be able to assign the place of the centre of gravity. When the magnitude and figure of the body, and the density of the matter which occupies its dimensions, are known, the place of the centre of gravity can be determined with the greatest precision by mathematical calculation. The process by which this is accomplished, however, is not of a sufficiently elementary nature to be properly introduced into this treatise. To render it intelligible would require the aid of some of the most advanced analytical principles; and even to express the position of the point in question, except in very particular instances, would be impossible, without the aid of peculiar symbols.

There are certain particular forms of body in which, when they are uniformly dense, the place of the centre of gravity can be easily assigned, and

proved by reasoning which is generally intelligible ; but in all cases whatever this point may be easily determined by experiment.

If a body uniformly dense have such a shape that a point may be found, on either side of which, in all directions around it, the materials of the body are similarly distributed, that point will obviously be the centre of gravity. For if it be supported, the gravitation of the particles on one side drawing them downward, is resisted by an effect of exactly the same kind and of equal amount on the opposite side, and so the body remains balanced on the point.

The most remarkable body of this kind is a globe, the centre of which is evidently its centre of gravity.

A figure, such as fig. 2, called an *oblate spheroid*, has its centre of gravity

Fig. 2.

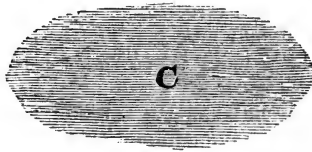

at its centre, C. Such is the figure of the earth. The same may be observed of the elliptical solid, fig. 3, which is called a *prolate spheroid*.

Fig. 3.



A cube, and some other regular solids, bounded by plane surfaces, have a point within them, such as above described, and which is therefore their centre of gravity. Such are figs. 4. and 5.

Fig. 4.

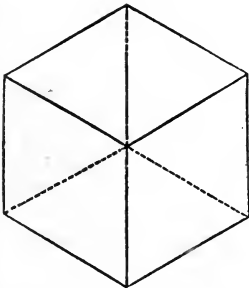
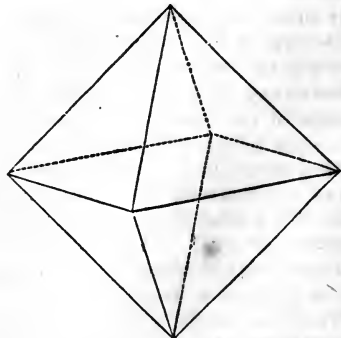

Fig. 5.



A straight wand, of uniform thickness, has its centre of gravity at the centre of its length; and a cylindrical body has its centre of gravity in its centre, at the middle of its length or axis. Such is the point C, fig. 6.

Fig. 6.

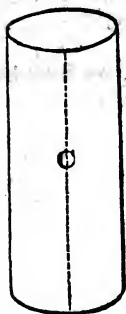
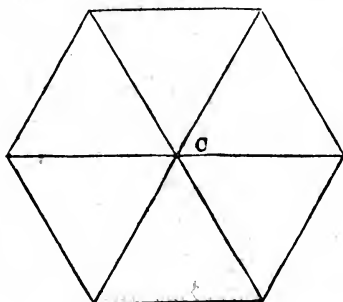

Fig. 7.



A flat plate of any uniform substance, and which has in every part an equal thickness, has its centre of gravity at the middle of its thickness, and under a point of its surface, which is to be determined by its shape. If it be circular or elliptical, this point is its centre. If it have any regular form, bounded by straight edges, it is that point which is equally distant from its several angles, as C in fig. 7.

There are some cases in which, although the place of the centre of gravity is not so obvious as in the examples just given, still it may be discovered without any mathematical process, which is not easily understood. Suppose A B C, fig. 8, to be a flat triangular plate of uniform thickness and density. Let it be

Fig. 8.

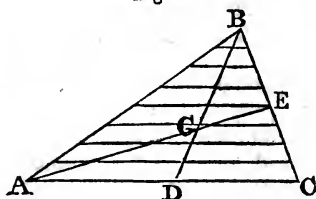

imagined to be divided into narrow bars, by lines parallel to the side A C, as represented in the figure. Draw B D from the angle B to the middle point D of the side A C. It is not difficult to perceive that B D will divide equally all the bars into which the triangle is conceived to be divided. Now, if the flat triangular plate A B C be placed in a horizontal position on a straight edge coinciding with the line B D, it will be balanced; for the bars parallel to A C will be severally balanced by the edge immediately under their middle point, since that middle point is the centre of gravity of each bar. Since, then, the triangle is balanced on the edge, the centre of gravity must be somewhere immediately over it, and must therefore be within the plate, at some point under the line B D.

The same reasoning will prove that the centre of gravity of the plate is under the line A E, drawn from the angle A to the middle point E of the side B C. To perceive this, it is only necessary to consider the triangle divided into bars parallel to B C, and thence to show that it will be balanced on an

edge placed under A E. Since, then, the centre of gravity of the plate is under the line B D, and also under A E, it must be under the point G, at which these lines cross each other; and it is accordingly at a depth beneath G, equal to half the thickness of the plate.

This may be experimentally verified by taking a piece of tin or card, and cutting it into a triangular form. The point G being found by drawing B D and A E, which divide two sides equally, it will be balanced if placed upon the point of a pin at G.

The centre of gravity of a triangle being thus determined, we shall be able to find the position of the centre of gravity of any plate of uniform thickness and density which is bounded by straight edges.

The centre of gravity is not always included within the volume of the body, that is, it is not enclosed by its surfaces. Numerous examples of this can be produced. If a piece of wire be bent into any form, the centre of gravity will rarely be in the wire. Suppose it be brought to the form of a ring. In that case, the centre of gravity of the wire will be the centre of the circle, a point not forming any part of the wire itself: nevertheless this point may be proved to have the characteristic property of the centre of gravity; for if the ring be suspended by any point, the centre of the ring must always settle itself under the point of suspension. If this centre could be supposed to be connected with the ring by very fine threads, whose weight would be insignificant, and which might be united by a knot or otherwise at the centre, the ring would be balanced upon a point placed under the knot.

In like manner, if the wire be formed into an ellipse, or any other curve similarly arranged round a centre point, that point will be its centre of gravity.

To find the centre of gravity experimentally, the method explained in fig. 1 may be used. In this case two points of suspension will be sufficient to determine it; for the directions of the suspending cord, being continued through the body, will cross each other at the centre of gravity. These directions may also be found by placing the body on a sharp point, and adjusting it so as to be balanced upon it. In this case, a line drawn through the body directly upward from the point will pass through the centre of gravity, and therefore two such lines must cross at that point.

If the body have two flat parallel surfaces, like sheet metal, stiff paper, card, board, &c., the centre of gravity may be found by balancing the body in two positions on a horizontal straight edge. The point where the lines marked by the edge cross each other will be immediately under the centre of gravity. This may be verified by showing that the body will be balanced on a point thus placed, or that, if it be suspended, the point thus determined will always come under the point of suspension.

The position of the centre of gravity of such bodies may also be found by placing the body on a horizontal table having a straight edge. The body being moved beyond the edge until it is in that position in which the slightest disturbance will cause it to fall, the centre of gravity will then be immediately over the edge. This being done in two positions, the centre of gravity will be determined as before.

It has been already stated that when the body is perfectly free, the centre of gravity must necessarily move downward, in a direction perpendicular to a horizontal plane. When the body is not free, the circumstances which restrain it generally permit the centre of gravity to move in certain directions, but obstruct its motion in others. Thus, if a body be suspended from a fixed point by a flexible cord, the centre of gravity is free to move in every direction except those which would carry it farther from the point of suspension than the length of the cord. Hence if we conceive a globe or sphere to sur-

round the point of suspension on every side to a distance equal to that of the centre of gravity from the point of suspension, when the cord is fully stretched, the centre of gravity will be at liberty to move in every direction within this sphere.

There are an infinite variety of circumstances under which the motion of a body may be restrained, and in which a most important and useful class of mechanical problems originate. Before we notice others, we shall, however, examine that which has just been described more particularly.

Fig. 9.

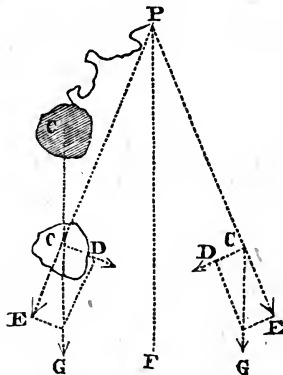

Let P, fig. 9, be the point of suspension, and C the centre of gravity, and suppose the body to be so placed that C shall be within the sphere already described. The cord will therefore be slackened, and in this state the body will be free. The centre of gravity will therefore descend in the perpendicular direction until the cord becomes fully extended; the tension will then prevent its further motion in the perpendicular direction. The downward force must now be considered as the diagonal of a parallelogram, and equivalent to two forces C D and C E, in the directions of the sides, as already explained in fig. 1. The force C D will bring the centre of gravity into the direction P F, perpendicularly under the point of suspension. Since the force of gravity acts continually on C in its approach to P F, it will move toward that line with accelerated speed, and when it has arrived there, it will have acquired a force to which no obstruction is immediately opposed, and consequently by its inertia it retains this force, and moves beyond P F on the other side. But when the point C gets into the line P F, it must therefore begin to ascend, and the force of gravity, which in the former case accelerated its descent, will now, for the same reason, and with equal energy, oppose its ascent. This will be easily understood. Let C' be any point which it may have attained in ascending: C' G', the force of gravity, is now equivalent to C' D' and C' E'. The latter, as before, produces tension; but the former, C' D', is in a direction immediately opposed to the motion, and therefore retards it. This retardation will continue until all the motion acquired by the body in its descent from the first position has been destroyed, and then it will begin to return to P F, and so it will continue to vibrate from the one side to the other until the friction on the point P, and the resistance of the air, gradually deprive it of its motion, and bring it to a state of rest in the direction P F.

But for the effects of friction and atmospheric resistance, the body would continue for ever to oscillate equally from side to side of the line P F.

The phenomenon just developed is only an example of an extensive class. Whenever the circumstances which restrain the body are of such a nature that the centre of gravity is prevented from descending below a certain level, but not, on the other hand, restrained from rising above it, the body will remain at rest if the centre of gravity be placed at the lowest limit of its level; any disturbance will cause it to oscillate around this state, and it cannot return to a state of rest until friction or some other cause have deprived it of the motion communicated by the disturbing force.

Under the circumstances which we have just described, the body could not maintain itself in a state of rest in any position except that in which the centre of gravity is, at the lowest point of the space in which it is free to move. This, however, is not always the case. Suppose it were suspended by an inflexible rod instead of a flexible string: the centre of gravity would then not only be prevented from receding from the point of suspension, but also from approaching it; in fact, it would be always kept at the same distance from it. Thus, instead of being capable of moving anywhere within the sphere, it is now capable of moving on its surface only. The reasoning used in the last case may also be applied here, to prove that when the centre of gravity is on either side of the perpendicular P F, it will fall toward P F, and oscillate, and that, if it be placed in the line P F, it will remain in equilibrium. But in this case there is another position, in which the centre of gravity may be placed so as to produce equilibrium. If it be placed at the highest point of the sphere in which it moves, the whole force on it will then be directed on the point of suspension, perpendicularly downward, and will be entirely expended in producing pressure on that point; consequently the body will in this case be in equilibrium. But this state of equilibrium is of a character very different from that in which the centre of gravity was at the lowest part of the sphere. In the present case, any displacement, however slight, of the centre of gravity, will carry it to a lower level, and the force of gravity will then prevent its return to its former state, and will impel it downward until it attain the lowest point of the sphere, and round that point it will oscillate.

The two states of equilibrium which have been just noticed are called stable and instable equilibrium. The character of the former is, that any disturbance of the state produces oscillation about it; but any disturbance of the latter state produces a total overthrow, and finally causes oscillation around the state of stable equilibrium.

Let A B, fig. 10, be an elliptical board resting on its edge on a horizontal plane. In the position here represented, the extremity P of the lesser axis

Fig. 10.

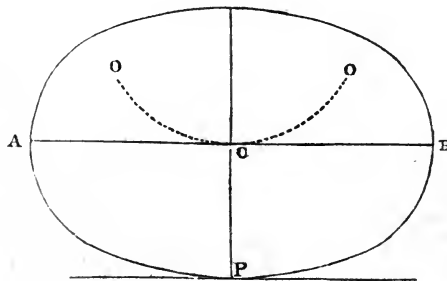

being the point of support, the board is in stable equilibrium; for any motion on either side must cause the centre of gravity C to ascend in the directions CO , and oscillation will ensue. If, however, it rest upon the smaller end, as in fig. 11, the position would still be a state of equilibrium, because the centre

Fig. 11.

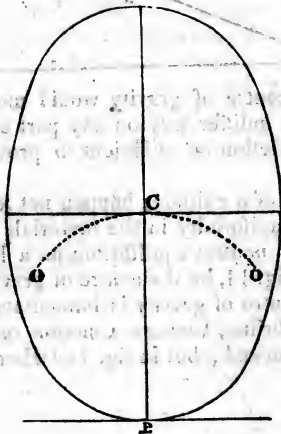

of gravity is directly above the point of support; but it would be instable equilibrium, because the slightest displacement of the centre of gravity would cause it to descend.

Thus an egg or a lemon may be balanced on the end; but the least disturbance will overthrow it. On the contrary, it will easily rest on the side, and any disturbance will produce oscillation.

When the circumstances under which the body is placed allow the centre of gravity to move only in a horizontal line, the body is in a state which may be called *neutral equilibrium*. The slightest force will move the centre of gravity, but will neither produce oscillation nor overthrow the body, as in the last two cases.

An example of this state is furnished by a cylinder placed upon a horizontal plane. As the cylinder is rolled upon the plane, the centre of gravity C , fig. 12, moves in a line parallel to the plane AB , and distant from it by the radius

Fig. 12.

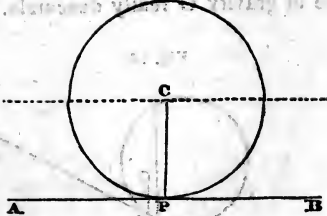

of the cylinder. The body will thus rest indifferently in any position, because the line of direction always falls upon a point P at which the body rests upon the plane.

If the plane were inclined, as in fig. 13, a body might be so shaped, that,

Fig. 13.

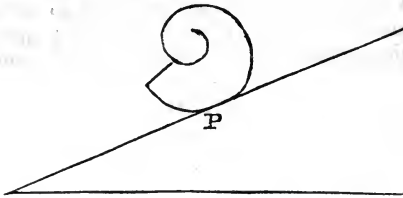

while it would roll, the centre of gravity would move horizontally. In this case, the body would rest indifferently on any part of the plane, as if it were horizontal, provided the friction be sufficient to prevent the body from sliding down the plane.

If the centre of gravity of a cylinder happen not to coincide with its centre, by reason of the want of uniformity in the materials of which it is composed, it will not be in a state of neutral equilibrium on a horizontal plane, as in fig. 12. In this case, let G , fig. 14, be the centre of gravity. In the position here represented, where the centre of gravity is immediately *below* the centre C , the state will be stable equilibrium, because a motion on either side would cause the centre of gravity to ascend; but in fig. 15, where G is immediately *above*

Fig. 14.

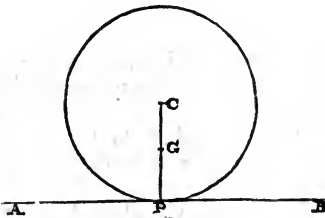
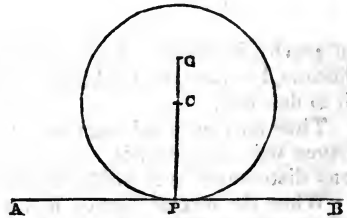

Fig. 15.



C , the state is instable equilibrium, because a motion on either side would cause G to descend, and the body would turn into the position fig. 14.

A cylinder of this kind will, under certain circumstances, roll up an inclined plane. Let $A B$, fig. 16, be the inclined plane, and let the cylinder be so placed that the line of direction from G shall be *above* the point P at which the cylinder rests upon the plane. The whole weight of the body acting in the direction $G D$ will obviously cause the cylinder to roll toward A , provided the friction be sufficient to prevent sliding; but although the cylinder in this case ascends, the centre of gravity G really descends.

Fig. 16.

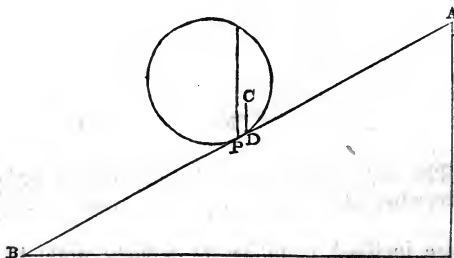
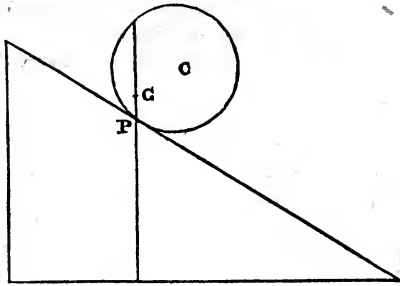
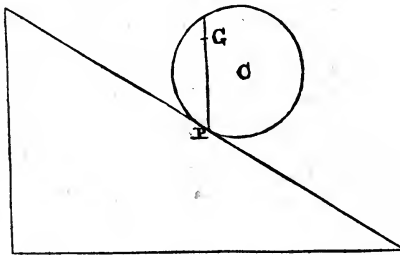

Fig. 17.



When G is so placed that the line of direction $G D$ shall fall on the point P , the cylinder will be in equilibrium, because its weight acts upon the point on which it rests. There are two cases represented in fig. 17 and fig. 18, in which G takes this position. Fig. 17 represents the state of stable, and fig. 18 of instable equilibrium.

Fig. 18.



When a body is placed upon a base, its stability depends upon the position of the line of direction and the height of the centre of gravity above the base. If the line of direction fall within the base, the body will stand firm; if it fall on the edge of the base, it will be in a state in which the slightest force will overthrow it on that side at which the line of direction falls; and if the line of direction fall without the base, the body must turn over that edge which is nearest to the line of direction.

In fig. 19 and fig. 20, the line of direction $G P$ falls within the base, and it

Fig. 19.

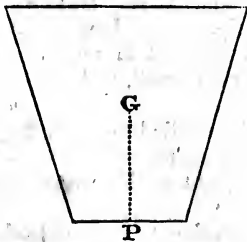
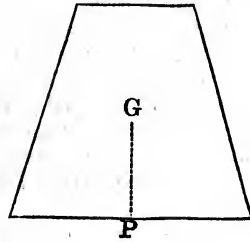

Fig. 20.



is obvious that the body will stand firm; for any attempt to turn it over either edge would cause the centre of gravity to ascend. But in fig. 21, the line of

direction falls upon the edge, and if the body be turned over, the centre of gravity immediately commences to descend. Until it be turned over, however, the centre of gravity is supported by the edge.

In fig. 22, the line of direction falls outside the base, the centre of gravity

Fig. 21.

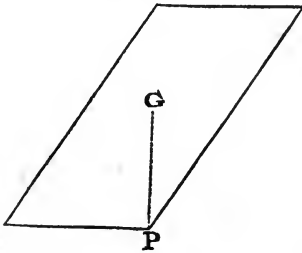
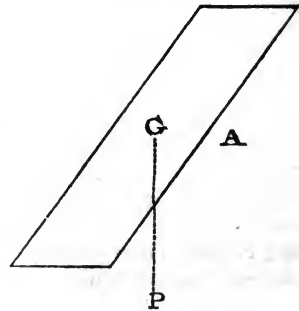

Fig. 22.



has a tendency to descend from G toward A, and the body will accordingly fall in that direction.

When the line of direction falls within the base, bodies will always stand firm, but not with the same degree of stability. In general, the stability depends on the height through which the centre of gravity must be elevated before the body can be overturned. The greater this height is, the greater in the same proportion will be the stability.

Let B A C, fig. 23, be a pyramid, the centre of gravity being at G. To

Fig. 23.

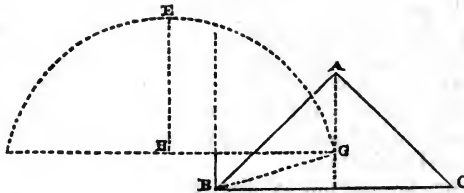

turn this over the edge B, the centre of gravity must be carried over the arch G E, and must therefore be raised through the height H E. If, however, the pyramid were taller relatively to its base, as in fig. 24, the height H E would be proportionally less; and if the base were very small in reference to the height, as in fig. 25, the height H E would be very small, and a slight force would throw it over the edge B.

It is obvious that the same observations may be applied to all figures whatever, the conclusions just deduced depending only on the distance of the line of direction from the edge of the base, and the height of the centre of gravity above it.

Hence we may perceive the principle on which the stability of loaded carriages depends. When the load is placed at a considerable elevation above the wheels, the centre of gravity is elevated, and the carriage becomes proportionally insecure. In coaches for the conveyance of passengers, the lug-

Fig. 24.

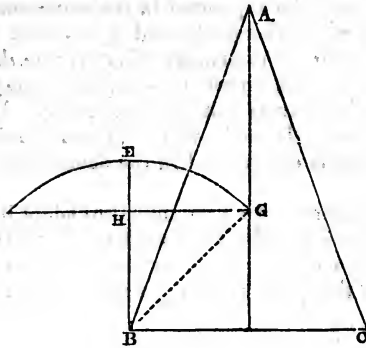

gage is therefore sometimes placed below the body of the coach ; light parcels of large bulk may be placed on the top with impunity.

When the centre of gravity of a carriage is much elevated, there is considerable danger of overthrow, if a corner be turned sharply and with a rapid pace ; for the centrifugal force then acting on the centre of gravity will easily raise it through the small height which is necessary to turn the carriage over the external wheels.

Fig. 25.

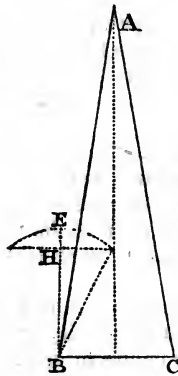

The same wagon will have greater stability when loaded with a heavy substance which occupies a small space, such as metal, than when it carries the same weight of a lighter substance, such as hay ; because the centre of gravity in the latter case will be much more elevated.

If a large table be placed upon a single leg in its centre, it will be impracticable to make it stand firm ; but if the pillar on which it rests terminate in a tripod, it will have the same stability as if it had three legs attached to the points directly over the places where the feet of the tripod rest.

When a solid body is supported by more points than one, it is not necessary for its stability that the line of direction should fall on one of those points. If there be only two points of support, the line of direction must fall between them. The body is in this case supported as effectually as if it rested on an edge coinciding with a straight line drawn from one point of support to the

other. If there be three points of support, which are not ranged in the same straight line, the body will be supported in the same manner as it would be by a base coinciding with the triangle formed by straight lines joining the three points of support. In the same manner, whatever be the number of points on which the body may rest, its virtual base will be found by supposing straight lines drawn, joining the several points successively. When the line of direction falls within this base, the body will always stand firm, and otherwise not. The degree of stability is determined in the same manner as if the base were a continued surface.

Necessity and experience teach an animal to adapt its postures and motions to the position of the centre of gravity of his body. When a man stands, the line of direction of his weight must fall within the base formed by his feet. If A B C D, fig. 26, be the feet, this base is the space A B C D. It is evident

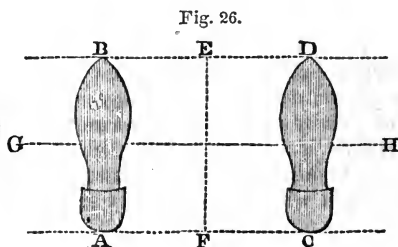

that the more his toes are turned outward, the more contracted the base will be in the direction E F, and the more liable he will be to fall backward or forward. Also the closer his feet are together, the more contracted the base will be in the direction G H, and the more liable he will be to fall toward either side.

When a man walks, the legs are alternately lifted from the ground, and the centre of gravity is either unsupported or thrown from the one side to the other. The body is also thrown a little forward, in order that the tendency of the centre of gravity to fall in the direction of the toes may assist the muscular action in propelling the body. This forward inclination of the body increases with the speed of the motion.

But for the flexibility of the knee-joint, the labor of walking would be much greater than it is; for the centre of gravity would be more elevated by each step. The line of motion of the centre of gravity in walking is represented by fig. 27, and deviates but little from a regular horizontal line, so that the eleva-

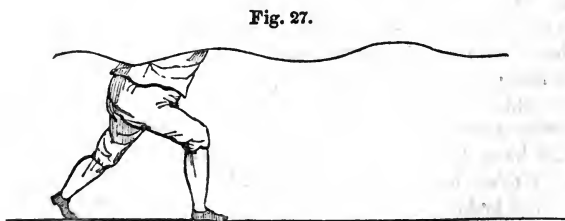

tion of the centre of gravity is subject to very slight variation. But if there were no knee-joint, as when a man has wooden legs, the centre of gravity

would move as in fig. 28, so that at each step the weight of the body would be lifted through a considerable height, and therefore the labor of walking would be much increased.

Fig. 28.



If a man stand on one leg, the line of direction of his weight must fall within the space on which his foot treads. The smallness of this space, compared with the height of the centre of gravity, accounts for the difficulty of this feat.

The position of the centre of gravity of the body changes with the posture and position of the limbs. If the arm be extended from one side, the centre of gravity is brought nearer to that side than it was when the arm hung perpendicularly. When dancers, standing on one leg, extend the other at right angles to it, they must incline the body in the direction opposite to that in which the leg is extended, in order to bring the centre of gravity over the foot which supports them.

Fig. 29.



When a porter carries a load, his position must be regulated by the centre of gravity of his body and the load taken together. If he bore the load on his

Fig. 30.



back, fig. 29, the line of direction would pass beyond his heels, and he would fall backward. To bring the centre of gravity over his feet, he accordingly leans forward, fig. 30.

If a nurse carry a child in her arms, she leans back for a like reason.

When a load is carried on the head, the bearer stands upright, that the centre of gravity may be over his feet. In ascending a hill, we appear to incline forward, and in descending, to lean backward; but in truth we are standing upright with respect to a level plane. This is necessary to keep the line of direction between the feet, as is evident from fig. 31.

Fig. 31.

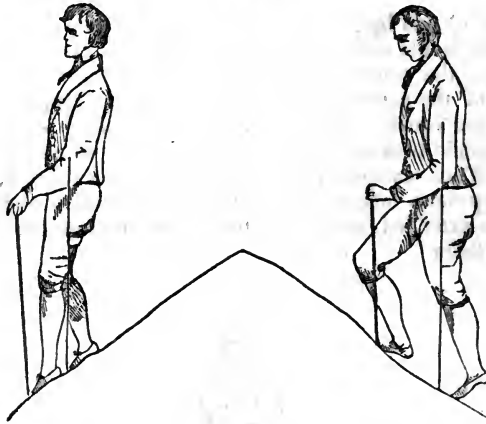

A person sitting on a chair which has no back, cannot rise from it without either stooping forward to bring the centre of gravity over the feet, or drawing back the feet to bring them under the centre of gravity.

A quadruped never raises both feet on the same side simultaneously, for the centre of gravity would then be unsupported. Let A B C D, fig. 32, be the

Fig. 32.

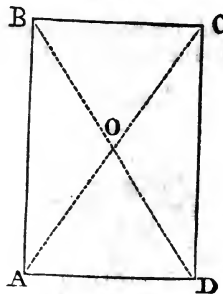

feet. The base on which it stands is A B C D, and the centre of gravity is nearly over the point O, where the diagonals cross each other: The legs A and C being raised together, the centre of gravity is supported by the legs B and D, since it falls between them; and when B and D are raised, it is, in like manner, supported by the feet A and C. The centre of gravity, however,

is often unsupported for a moment; for the leg B is raised from the ground before A comes to it, as is plain from observing the track of a horse's feet, the mark of A being upon or before that of B. In the more rapid paces of all animals the centre of gravity is at intervals unsupported.

The feats of rope-dancers are experiments on the management of the centre of gravity. The evolutions of the performer are found to be facilitated by holding in his hand a heavy pole. His security in this case depends, not on the centre of gravity of his body, but on that of his body and the pole taken together. This point is near the centre of the pole, so that, in fact, he may be said to hold in his hands the point on the position of which the facility of his feats depends. Without the aid of the pole, the centre of gravity would be within the trunk of the body, and its position could not be adapted to circumstances with the same ease and rapidity.

The centre of gravity of a mass of fluid is that point which would have the properties which have been proved to belong to the centre of gravity of a solid, if the fluid were solidified without changing in any respect the quantity or arrangement of its parts.

The centre of gravity of two bodies separated from one another, is that point which would possess the properties ascribed to the centre of gravity if the two bodies were united by an inflexible line, the weight of which might be neglected. To find this point mathematically is a very simple problem. Let A B, fig. 33, be

Fig. 33.

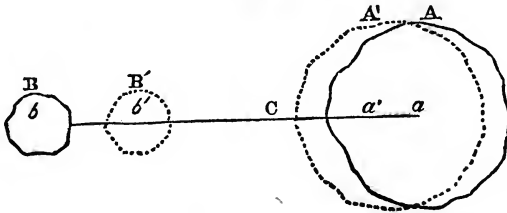

the two bodies, and a and b their centres of gravity. Draw the right line $a b$, and divide it at C , in such a manner that $a C$ shall have the same proportion to $b C$ as the mass of the body B has to the mass of the body A .

This may easily be verified experimentally. Let A and B be two bodies, whose weight is considerable, in comparison with that of the rod $a b$, which joins them. Let a fine silken string, with its ends attached to them, be hung upon a pin, and on the same pin let a plumb-line be suspended. In whatever position the bodies may be hung, it will be observed that the plumb-line will cross the rod $a b$ at the same point, and that point will divide the line $a b$ into parts $a C$ and $b C$, which are in the proportion of the mass of B to the mass of A .

The centre of gravity of three separate bodies is defined in the same manner as that of two, and may be found by first determining the centre of gravity of two, and then supposing their masses concentrated at that point, so as to form one body, and finding the centre of gravity of that and the third.

In the same manner the centre of gravity of any number of bodies may be determined.

If a plate of uniform thickness be bounded by straight edges, its centre of gravity may be found by dividing it into triangles by diagonal lines, as in fig. 34, and, having determined the centres of gravity of the several triangles, the centre of gravity of the whole plate will be their common centre of gravity found as above.

Fig. 34.

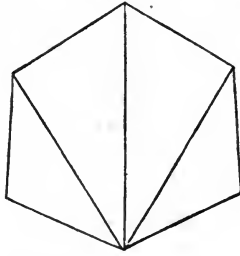

Although the centre of gravity takes its name from the familiar properties which it has in reference to detached bodies of inconsiderable magnitude, placed on or near the surface of the earth, yet it possesses properties of a much more general and not less important nature. One of the most remarkable of these is, that the centre of gravity of any number of separate bodies is never affected by the mutual attraction, impact, or other influence which the bodies may transmit from one to another. This is a necessary consequence of the equality of action and reaction; for if A and B , fig. 33, attract each other, and change their places to A' B' , the space $a a'$ will have to $b b'$ the same proportion as B has to A , and therefore, by what has just been proved in fig. 33, the same proportion as $a C$ has to $b C$. It follows that the remainders $a' C$ and $b' C$ will be in the proportion of B to A , and that C will continue to be the centre of gravity of the bodies after they have approached by their mutual attraction.

Suppose, for example, that A and B were twelve pounds and eight pounds respectively, and that $a b$ were forty feet. The point C must divide $a b$ into two parts, in the proportion of eight to twelve, or of two to three. Hence it is obvious that $a C$ will be sixteen feet, and $b C$ twenty-four feet. Now, suppose that A and B attract each other, and that A approaches B through two feet. Then B must approach A through three feet. Their distances from C will now be fourteen feet and twenty-one feet, which, being in the proportion of B to A , the point C will still be their centre of gravity.

Hence it follows, that if a system of bodies, placed at rest, be permitted to obey their mutual attractions, although the bodies will thereby be severally moved, yet their common centre of gravity must remain quiescent.

When one of two bodies is moving in a straight line, the other being at rest, their common centre of gravity must move in a parallel straight line. Let A and B , fig. 35, be the centres of gravity of the bodies, and let A move from A to a , B remaining at rest. Draw the lines $A B$ and $a B$. In every position which the body B assumes during its motion, the centre of gravity C divides the line joining them into parts $A C$, $B C$, which are in the proportion of the mass B to the mass A . Now, suppose any number of lines drawn from B to the line $A a$; a parallel $C c$ to $A a$ through C divides all these lines in the same proportion; and therefore, while the body A moves from A to a , the common centre of gravity moves from C to c .

If both the bodies A and B moved uniformly in straight lines, the centre of gravity would have a motion compounded of the two motions with which it would be affected, if each moved while the other remained at rest. In the same manner, if there were three bodies, each moving uniformly in a straight line, their common centre of gravity would have a motion compounded of that motion which it would have if one remained at rest while the other two moved,

Fig. 35.

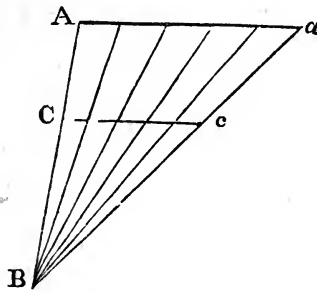

and that which the motion of the first would give it if the last two remained at rest; and in the same manner it may be proved, that when any number of bodies move each in a straight line, their common centre of gravity will have a motion compounded of the motions which it receives from the bodies severally.

It may happen that the several motions which the centre of gravity receives from the bodies of the system will neutralize each other; and this does, in fact, take place for such motions as are the consequences of the mutual action of the bodies upon one another.

If a system of bodies be not under the immediate influence of any forces, and their mutual attraction be conceived to be suspended, they must severally be either at rest or in uniform rectilinear motion in virtue of their inertia. Hence their common centre of gravity must also be either at rest or in uniform rectilinear motion. Now, if we suppose their mutual attractions to take effect, the state of their common centre of gravity will not be changed, but the bodies will severally receive motions compounded of their previous uniform rectilinear motions and those which result from their mutual attractions. The combined effects will cause each body to revolve in an orbit round the common centre of gravity, or will precipitate it toward that point. But still that point will maintain its former state undisturbed.

This constitutes one of the general laws of mechanical science, and is of great importance in physical astronomy. It is known by the title "the conservation of the motion of the centre of gravity."

The solar system is an instance of the class of phenomena to which we have just referred. All the motions of the bodies which compose it can be traced to certain uniform rectilinear motions, received from some former impulse, or from a force whose action has been suspended, and those motions which necessarily result from the principle of gravitation. But we shall not here insist further on this subject, which more properly belongs to another department of the science.

If a solid body suffer an impact in the direction of a line passing through its centre of gravity, all the particles of the body will be driven forward with the same velocity in lines parallel to the direction of the impact, and the whole force of the motion will be equal to that of the impact. The impelling force being equally distributed among all the parts, the velocity will be found by dividing the numerical value of that force by the number expressing the mass.

If any number of impacts be given simultaneously to different points of a body, a certain complex motion will generally ensue. The mass will have a relative motion round the centre of gravity as if it were fixed, while that point will move forward uniformly in a straight line, carrying the body with it. The

relative motion of the mass round the centre of gravity may be found by considering the centre of gravity as a fixed point, round which the mass is free to move, and then determining the motion which the applied forces would produce. This motion being supposed to continue uninterrupted, let all the forces be imagined to be applied in their proper directions and quantities to the centre of gravity. By the principles for the composition of force they will be mechanically equivalent to a single force through that point. In the direction of this single force the centre of gravity will move, and have the same velocity as if the whole mass were there concentrated and received the impelling forces.

These general properties, which are entirely independent of gravity, render the "centre of gravity" an inadequate title for this important point. Some physical writers have consequently called it the "centre of inertia." The "centre of gravity," however, is the name by which it is still generally designated.

THE LEVER AND WHEELWORK.

Simple Machine.—Statics.—Dynamics.—Force.—Power.—Weight.—Lever.—Jord.—Inclined Plane.—Arms.—Fulcrum.—Three kinds of Lever.—Crow-Bar.—Handspike.—Car.—Nut-Crackers.—Turning Lathe.—Steelyard.—Rectangular Lever.—Hammer.—Load between two Bearers.—Combination of Levers.—Equivalent Lever.—Wheel and Axle.—Thickness of the Rope.—Ways of applying the Power.—Projecting Pins.—Windlass.—Winch.—Axle.—Horizontal Wheel.—Tread-mill.—Cranes.—Water-Wheels.—Paddle-Wheel.—Ratchet-Wheel.—Rack.—Spring of a Watch.—Fusee.—Straps or Cords.—Examples of.—Turning Lathe.—Revolving Shafts.—Spinning Machinery.—Saw-Mill.—Pinion.—Leaves.—Crane.—Spur-Wheels.—Crown-Wheels.—Bevelled Wheels.—Hunting-Cog.—Chronometers.—Hair-Spring.—Balance-Wheel.

1887

1887
1888
1889
1890
1891
1892
1893
1894
1895
1896
1897

THE LEVER AND WHEELWORK.

A MACHINE is an instrument by which force or motion may be transmitted and modified as to its quantity and direction. There are two ways in which a machine may be applied, and which give rise to a division of mechanical science into parts denominated *statics* and *dynamics*; the one including the theory of equilibrium, and the other the theory of motion. When a machine is considered statically, it is viewed as an instrument by which forces of determinate quantities and directions are made to balance other forces of other quantities and other directions. If it be viewed dynamically, it is considered as a means by which certain motions of determinate quantity and direction may be made to produce other motions in other directions and quantities. It will not be convenient, however, in the present treatise, to follow this division of the subject. We shall, on the other hand, as hitherto, consider the phenomena of equilibrium and motion together.

The effects of machinery are too frequently described in such a manner as to invest them with the appearance of paradox, and to excite astonishment at what appears to contradict the results of the most common experience. It will be our object here to take a different course, and to attempt to show that those effects which have been held up as matters of astonishment are the necessary, natural, and obvious results of causes adapted to produce them in a manner analogous to the objects of most familiar experience.

In the application of a machine there are three things to be considered: 1. The force or resistance which is required to be sustained, opposed, or overcome. 2. The force which is used to sustain, support, or overcome, that resistance. 3. The machine itself, by which the effect of this latter force is transmitted to the former. Of whatever nature be the force or the resistance which is to be sustained or overcome, it is technically called the *weight*, since, whatever it be, a weight of equivalent effect may always be found. The force which is employed to sustain or overcome it is technically called the *power*.

In expressing the effect of machinery, it is usual to say that the power sustains the weight; but this, in fact, is not the case, and hence arises that appearance of paradox which has already been alluded to. If, for example, it is said that a power of one ounce sustains the weight of one ton, astonishment is not unnaturally excited, because the fact, as thus stated, if the terms be literally interpreted, is physically impossible. No power less than a ton can, in the ordinary acceptation of the word, support the weight of a ton. It will, however, be asked how it happens that a machine *appears* to do this? how it happens that by holding a silken thread, which an ounce weight would snap, many hundred weight may be sustained? To explain this, it will only be necessary to consider the effect of a machine, when the power and weight are in equilibrium.

In every machine there are some fixed points or props; and the arrangement of the parts is always such that the pressure, excited by the power or weight, or both, is distributed among these props. If the weight amount to twenty hundred, it is possible so to distribute it that any proportion, however great, of it may be thrown on the fixed points or props of the machine; the remaining part only can properly be said to be supported by the power; and this part can never be greater than the power. Considering the effect in this way, it appears that the power supports just so much of the weight, and no more, as is equal to its own force, and that all the remaining part of the weight is sustained by the machine.

The force of these observations will be more apparent when the nature and properties of the mechanic powers and other machines have been explained.

When a machine is used dynamically, its effects are explained on different principles. It is true that, in this case, a very small power may elevate a very great weight; but, nevertheless, in so doing, whatever be the machine used, the total expenditure of power, in raising the weight through any height, is never less than that which would be expended if the power were immediately applied to the weight without the intervention of any machine. This circumstance arises from a universal property of machines, by which the velocity of the weight is always less than that of the power, in exactly the same proportion as the power itself is less than the weight; so that, when a certain power is applied to elevate a weight, the rate at which the elevation is effected is always slow in the same proportion as the weight is great. From a due consideration of this remarkable law, it will easily be understood that a machine can never diminish the total expenditure of power necessary to raise any weight or to overcome any resistance. In such cases, all that a machine ever does, or ever can do, is to enable the power to be expended at a slow rate, and in a more advantageous direction than if it were immediately applied to the weight or the resistance.

Let us suppose that P is a power amounting to an ounce, and that W is a weight amounting to 50 ounces, and that P elevates W by means of a machine. In virtue of the property already stated, it follows that, while P moves through 50 feet, W will be moved through 1 foot; but in moving P through 50 feet, 50 distinct efforts are made, by each of which 1 ounce is moved through 1 foot, and by which collectively 50 distinct ounces might be successively raised through 1 foot. But the weight W is 50 ounces, and has been raised through 1 foot; whence it appears that the expenditure of power is equal to that which would be necessary to raise the weight without the intervention of any machine.

This important principle may be presented under another aspect, which will perhaps render it more apparent. Suppose the weight W were actually divided into 50 equal parts, or suppose it were a vessel of liquid weighing 50 ounces,

and containing 50 equal measures ; if these 50 measures were successively lifted through a height of 1 foot, the efforts necessary to accomplish this would be the same as those used to move the power P through 50 feet, and it is obvious that the total expenditure of force would be the same as that which would be necessary to lift the entire contents of the vessel through 1 foot.

When the nature and properties of the mechanic powers and other machines have been explained, the force of these observations will be more distinctly perceived. The effects of props and fixed points in sustaining part of the weight, and sometimes the whole, both of the weight and power, will then be manifest, and every machine will furnish a verification of the remarkable proportion between the velocities of the weight and power, which has enabled us to explain what might otherwise be paradoxical and difficult of comprehension.

The most simple species of machines are those which are commonly denominated the *mechanic powers*. These have been differently enumerated by different writers. If, however, the object be to arrange in distinct classes, and in the smallest possible number of them, those machines which are alike in principle, the mechanic powers may be reduced to three :—

1. The lever.
2. The cord.
3. The inclined plane.

To one or other of these classes all simple machines whatever may be reduced, and all complex machines may be resolved into simple elements which come under them.

The first class includes every machine which is composed of a solid body revolving on a fixed axis, although the name *lever* has been commonly confined to cases where the machine affects certain particular forms. The power and weight are always supposed to be applied in directions at right angles to the axis. If lines be drawn from the axis perpendicular to the directions of power and weight, equilibrium will subsist, provided the power, multiplied by the perpendicular distance of its direction from the axis, be equal to the weight multiplied by the perpendicular distance of its direction from the axis. This is a principle to which we shall have occasion to refer in explaining the various machines of this class.

If the moment of the power be greater than that of the weight, the effect of the power will prevail over that of the weight, and elevate it ; but if, on the other hand, the moment of the power be less than that of the weight, the power will be insufficient to support the weight, and will allow it to fall.

The second class of simple machines includes all those cases in which force is transmitted by means of flexible threads, ropes, or chains. The principle by which the effects of these machines are estimated is, that the tension throughout the whole length of the same cord, provided it be perfectly flexible, and free from the effects of friction, must be the same. Thus, if a force acting at one end be balanced by a force acting at the other end, however the cord may be bent, or whatever course it may be compelled to take, by any causes which may affect it between its ends, these forces must be equal, provided the cord be free to move over any obstacles which may deflect it.

Within this class of machines are included all the various forms of *pulleys*.

The third class of simple machines includes all those cases in which the weight or resistance is supported or moved on a hard surface inclined to the vertical direction.

The effects of such machines are estimated by resolving the whole weight of the body into two elements by the parallelogram of forces. One of these

elements is perpendicular to the surface, and supported by its resistance; the other is parallel to the surface, and supported by the power. The proportion, therefore, of the power to the weight will always depend on the obliquity of the surface to the direction of the weight.

Under this class of machines come the inclined plane, commonly so called, the wedge, the screw, and various others.

In order to simplify the development of the elementary theory of machines, it is expedient to omit the consideration of many circumstances, of which, however, a strict account must be taken before any practically useful application of that theory can be attempted. A machine, as we must for the present contemplate it, is a thing which can have no real or practical existence. Its various parts are considered to be free from friction: all surfaces which move in contact, are supposed to be infinitely smooth and polished. The solid parts are conceived to be absolutely inflexible. The weight and inertia of the machine itself are wholly neglected, and we reason upon it as if it were divested of these qualities. Cords and ropes are supposed to have no stiffness, to be infinitely flexible. The machine, when it moves, is supposed to suffer no resistance from the atmosphere, and to be in all respects circumstanced as if it were *in vacuo*.

It is scarcely necessary to state that, all these suppositions being false, none of the consequences deduced from them can be true. Nevertheless, as it is the business of art to bring machines as near to this state of ideal perfection as possible, the conclusions which are thus obtained, though false in a strict sense, yet deviate from the truth in but a small degree. Like the first outline of a picture, they resemble, in their general features, that truth to which, after many subsequent corrections, they must finally approximate.

After a first approximation has been made on the several false suppositions which have been mentioned, various effects, which have been previously neglected, are successively taken into account. Roughness, rigidity, imperfect flexibility, the resistance of air and other fluids, the effects of the weight and inertia of the machine, are severally examined, and their laws and properties detected. The modifications and corrections, thus suggested as necessary to be introduced into our former conclusions, are applied, and a second approximation, but still *only* an approximation, to truth is made. For, in investigating the laws which regulate the several effects just mentioned, we are compelled to proceed upon a new group of false suppositions. To determine the laws which regulate the friction of surfaces, it is necessary to assume that every part of the surfaces of contact is uniformly rough; that the solid parts which are imperfectly rigid, and the cords which are imperfectly flexible, are constituted throughout their entire dimensions of a uniform material; so that the imperfection does not prevail more in one part than another. Thus all irregularity is left out of account, and a general average of the effects taken. It is obvious, therefore, that by these means we have still failed in obtaining a result exactly conformable to the real state of things; but it is equally obvious that we have obtained one much more conformable to that state than had been previously accomplished, and sufficiently near it for most practical purposes.

This apparent imperfection in our instruments and powers of investigation is not peculiar to mechanics; it pervades all departments of natural science. In astronomy, the motions of the celestial bodies, and their various changes and appearances, as developed by theory, assisted by observation and experience, are only approximations to the real motions and appearances which take place in nature. It is true that these approximations are susceptible of almost unlimited accuracy; but still they are, and ever will continue to be, only approxima-

tions. Optics and all other branches of natural science are liable to the same observations.

THE LEVER.

An inflexible, straight bar, turning on an axis, is commonly called a *lever*. The *arms* of the lever are those parts of the bar which extend on each side of the axis.

The axis is called the *fulcrum* or *prop*.

Levers are commonly divided into three kinds, according to the relative positions of the power, the weight, and the fulcrum.

In a lever of the first kind, as in fig. 1, the fulcrum is between the power and weight.

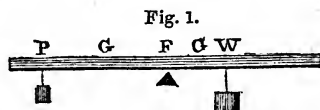

In a lever of the second kind, as in fig. 2, the weight is between the fulcrum and power.

In a lever of the third kind, as in fig. 3, the power is between the fulcrum and weight.

Fig. 2.

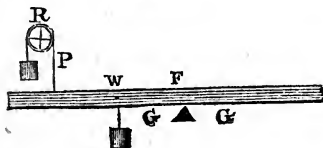
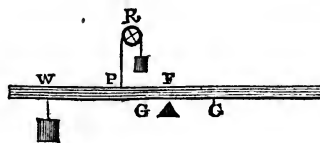

Fig. 3.



In all these cases the power will sustain the weight in equilibrium, provided its moment be equal to that of the weight. But the moment of the power is, in this case, equal to the product obtained by multiplying the power by its distance from the fulcrum, and the moment of the weight, by multiplying the weight by its distance from the fulcrum. Thus, if the number of ounces in P , being multiplied by the number of inches in $P F$, be equal to the number of ounces in W , multiplied by the number of inches in $W F$, equilibrium will be established. It is evident from this, that, as the distance of the power from the fulcrum increases in comparison to the distance of the weight from the fulcrum, in the same degree exactly will the proportion of the power to the weight diminish. In other words, the proportion of the power to the weight will be always the same as that of their distances from the fulcrum taken in a reverse order.

In cases where a small power is required to sustain or elevate a great weight, it will therefore be necessary either to remove the power to a great distance from the fulcrum, or to bring the weight very near it.

Numerous examples of levers of the first kind may be given. A crowbar, applied to elevate a stone or other weight, is an instance. The fulcrum is another stone placed near that which is to be raised, and the power is the hand placed at the other end of the bar.

A handspike is a similar example.

A poker applied to raise fuel is a lever of the first kind, the fulcrum being the bar of the grate.

Scissors, shears, nippers, pincers, and other similar instruments, are composed of two levers of the first kind; the fulcrum being the joint or pivot, and the weight the resistance of the substance to be cut or seized; the power being the fingers applied at the other end of the levers.

The brake of a pump is a lever of the first kind; the pump-rods and piston being the weight to be raised.

Examples of levers of the second kind, though not so frequent as those just mentioned, are not uncommon.

An oar is a lever of the second kind: the reaction of the water against the blade is the fulcrum; the boat is the weight, and the hand of the boatman the power.

The rudder of a ship or boat is an example of this kind of lever, and explained in a similar way.

The chipping-knife is a lever of the second kind. The end attached to the bench is the fulcrum, and the weight the resistance of the substance to be cut, placed beneath it.

A door moved upon its hinges is another example.

Nut-crackers are two levers of the second kind; the hinge which unites them being the fulcrum, the resistance of the shell placed between them being the weight, and the hand applied to the extremity being the power.

A wheelbarrow is a lever of the second kind; the fulcrum being the point at which the wheel presses on the ground, and the weight being that of the barrow and its load, collected at their centre of gravity.

The same observation may be applied to all two-wheeled carriages, which are partly sustained by the animal which draws them.

In a lever of the third kind, the weight, being more distant from the fulcrum than the power, must be proportionably less than it. In this instrument, therefore, the power acts upon the weight to a mechanical disadvantage, inasmuch as a greater power is necessary to support or move the weight than would be required if the power were immediately applied to the weight, without the intervention of a machine. We shall, however, hereafter show that the advantage which is lost in force is gained in despatch, and that, in proportion as the weight is less than the power which moves it, so will the speed of its motion be greater than that of the power.

Hence a lever of the third kind is only used in cases where the exertion of great power is a consideration subordinate to those of rapidity and despatch.

The most striking example of levers of the third kind is found in the animal economy. The limbs of animals are generally levers of this description. The socket of the bone is the fulcrum; a strong muscle attached to the bone near the socket is the power; and the weight of the limb, together with whatever resistance is opposed to its motion, is the weight. A slight contraction of the muscle in this case gives a considerable motion to the limb: this effect is particularly conspicuous in the motion of the arms and legs in the human body; a very inconsiderable contraction of the muscles at the shoulders and hips giving the sweep to the limbs from which the body derives so much activity.

The treddle of the turning-lathe is a lever of the third kind. The hinge which attaches it to the floor is the fulcrum, the foot applied to it near the hinge is the power, and the crank upon the axis of the fly-wheel, with which its extremity is connected, is the weight.

Tongs are levers of this kind, as also the shears used in shearing sheep. In these cases, the power is the hand placed immediately below the fulcrum, or point where the two levers are connected.

When the power is said to support the weight by means of a lever or any other machine, it is only meant that the power keeps the machine in equilib-

rium, and thereby enables it to sustain the weight. It is necessary to attend to this distinction, to remove the difficulty which may arise from the paradox of a small power sustaining a great weight.

In a lever of the first kind, the fulcrum F , fig. 1, or axis, sustains the united forces of the power and weight.

In a lever of the second kind, if the power be supposed to act over a wheel, R , fig. 2, the fulcrum F sustains a pressure equal to the difference between the power and weight, and the axis of the wheel R sustains a pressure equal to twice the power; so that the total pressures on F and R are equivalent to the united forces of the power and weight.

In a lever of the third kind similar observations are applicable. The wheel R , fig. 3, sustains a pressure equal to twice the power, and the fulcrum F sustains a pressure equal to the difference between the power and weight.

These facts may be experimentally established by attaching a string to the lever immediately over the fulcrum, and suspending the lever by that string from the arm of a balance. The counterpoising weight, when the fulcrum is removed, will, in the first case, be equal to the sum of the weight and power, and in the last two cases equal to their difference.

We have hitherto omitted the consideration of the effect of the weight of the lever itself. If the centre of gravity of the lever be in the vertical line through the axis, the weight of the instrument will have no other effect than to increase the pressure on the axis by its own amount. But if the centre of gravity be on the same side of the axis with the weight, as at G , it will oppose the effect of the power, a certain part of which must therefore be allowed to support it. To ascertain what part of the power is thus expended, it is to be considered that the moment of the weight of the lever collected at G , is found by multiplying that weight by the distance $G F$. The moment of that part of the power which supports this must be equal to it; therefore, it is only necessary to find how much of the power multiplied by $P F$ will be equal to the weight of the lever multiplied by $G F$. This is a question in common arithmetic.

If the centre of gravity of the lever be at a different side of the axis from the weight, as at G' , the weight of the instrument will co-operate with the power in sustaining the weight W . To determine what portion of the weight W is thus sustained by the weight of the lever, it is only necessary to find how much of W , multiplied by the distance $W' F$, is equal to the weight of the lever multiplied by $G' F$.

In these cases, the pressure on the fulcrum, as already estimated, will always be increased by the weight of the lever.

The sense in which a small power is said to sustain a great weight, and the manner of accomplishing this, being explained, we shall now consider how the power is applied in moving the weight. Let $P W$, fig. 4, be the places of the

Fig. 4.

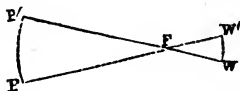

power and weight, and F that of the fulcrum, and let the power be depressed to P' while the weight is raised to W' . The space $P P'$ evidently bears the same proportion to $W W'$, as the arm $P F$ to $W F$. Thus, if $P F$ be ten times $W F$, $P P'$ will be ten times $W W'$. A power of one pound at P , being moved from P to P' , will carry a weight of ten pounds from W to W' . But in this case it ought not to be said that a lesser weight moves a greater, for it is not

difficult to show that the total expenditure of force in the motion of one pound from P to P' is exactly the same as in the motion of ten pounds from W to W' . If the space $P P'$ be ten inches, the space $W W'$ will be one inch. A weight of one pound is therefore moved through ten successive inches, and in each inch the force expended is that which would be sufficient to move one pound through one inch. The total expenditure of force from P to P' is ten times the force necessary to move one pound through one inch, or, what is the same, it is that which would be necessary to move ten pounds through one inch. But this is exactly what is accomplished by the opposite end, W , of the lever; for the weight W is ten pounds, and the space $W W'$ is one inch.

If the weight W of ten pounds could be conveniently divided into ten equal parts of one pound each, each part might be separately raised through one inch, without the intervention of the lever or any other machine. In this case, the same quantity of power would be expended, and expended in the same manner as in the case just mentioned.

It is evident, therefore, that when a machine is applied to raise a weight, or to overcome resistance, as much force must be really used as if the power were immediately applied to the weight or resistance. All that is accomplished by the machine is to enable the power to do that by a succession of distinct efforts which should be otherwise performed by a single effort. These observations will be found to be applicable to all other machines.

Weighing-machines of almost every kind, whether used for commercial or philosophical purposes, are varieties of the lever. The common balance, which, of all weighing-machines, is the most perfect, and best adapted for ordinary use, whether in commerce or experimental philosophy, is a lever with equal arms. In the steelyard, one weight serves as a counterpoise and measure of others of different amount, by receiving a leverage variable according to the varying amount of the weight against which it acts.

We have hitherto considered the power and weight as acting on the lever, in directions perpendicular to its length, and parallel to each other. This does not always happen. Let $A B$, fig. 5, be a lever whose fulcrum is F , and let A

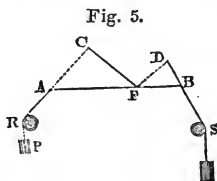

R be the direction of the power, and $B S$ the direction of the weight. If the lines $R A$ and $S B$ be continued, and perpendiculars $F C$ and $F D$ drawn from the fulcrum to those lines, the moment of the power will be found by multiplying the power by the line $F C$, and the moment of the weight by multiplying the weight by $F D$. If these moments be equal, the power will sustain the weight in equilibrium.

It is evident that the same reasoning will be applicable when the arms of the lever are not in the same direction. These arms may be of any figure or shape, and may be placed relatively to each other in any position.

In the rectangular lever the arms are perpendicular to each other, and the fulcrum F , fig. 6, is at the right angle. The moment of the power, in this case, is P multiplied by $A F$, and that of the weight W multiplied by $B F$. When the instrument is in equilibrium these moments must be equal.

When the hammer is used for drawing a nail, it is a lever of this kind. The

claw of the hammer is the shorter arm ; the resistance of the nail is the weight ; and the hand applied to the handle the power.

Fig. 6.

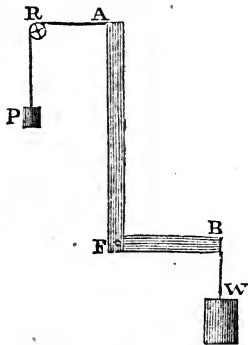
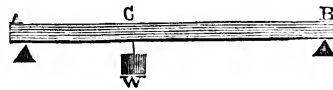

Fig. 7.



When a beam rests on two props, A B, fig. 7, and supports at some intermediate place, C, a weight, W, this weight is distributed between the props in a manner which may be determined by the principles already explained. If the pressure on the prop B be considered as a power sustaining the weight W, by means of the lever of the second kind, B A, then this power multiplied by B A must be equal to the weight multiplied by C A. Hence the pressure on B will be the same fraction of the weight as the part A C is of A B. In the same manner it may be proved, that the pressure on A is the same fraction of the weight as B C is of B A. Thus, if A C be one third, and therefore B C two thirds of B A, the pressure on B will be one third of the weight, and the pressure on A two thirds of the weight.

It follows from this reasoning that, if the weight be in the middle, equally distant from B and A, each prop will sustain half the weight. The effect of the weight of the beam itself may be determined by considering it to be collected at its centre of gravity. If this point, therefore, be equally distant from the props, the weight of the beam will be equally distributed between them.

According to these principles, the manner in which a load borne on poles between two bearers is distributed between them may be ascertained. As the efforts of the bearers and the direction of the weight are always parallel, the position of the poles relatively to the horizon makes no difference in the distribution of the weights between the bearers. Whether they ascend or descend, or move on a level plane, the weight will be similarly shared between them.

If the beam extend beyond the prop, as in fig. 8, and the weight be suspend-

Fig. 8.

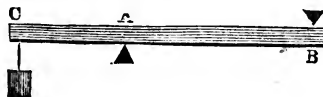

ed at a point not placed between them, the props must be applied at different sides of the beam. The pressures which they sustain may be calculated in the same manner as in the former case. The pressure of the prop B may be considered as a power sustaining the weight W by means of the lever B C. Hence the pressure of B, multiplied by B A, must be equal to the weight W multiplied by A C. Therefore the pressure on B bears the same proportion to

the weight as A C does to A B. In the same manner, considering B as a fulcrum, and the pressure of the prop A as the power, it may be proved that the pressure of A bears the same proportion to the weight as the line B C does to A B. It therefore appears that the pressure on the prop A is greater than the weight.

When great power is required, and it is inconvenient to construct a long lever, a combination of levers may be used. In fig. 9, such a system of levers

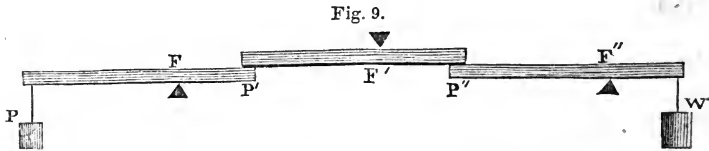

is represented, consisting of three levers of the first kind. The manner in which the effect of the power is transmitted to the weight may be investigated by considering the effect of each lever successively. The power at P produces an upward force at P', which bears to P the same proportion as P' F to P F. Therefore the effect at P' is as many times the power as the line P F is of P' F. Thus, if P F be ten times P' F, the upward force at P' is ten times the power. The arm, P' F', of the second lever is pressed upward by a force equal to ten times the power at P. In the same manner this may be shown to produce an effect at P'' as many times greater than P' as P' F' is greater than P'' F'. Thus, if P' F' be twelve times P'' F', the effect at P'' will be twelve times that of P'. But this last was ten times the power, and therefore the P'' will be one hundred and twenty times the power. In the same manner it may be shown that the weight is as many times greater than the effect at P'' as P'' F'' is greater than W F''. If P'' F'' be five times W F'', the weight will be five times the effect at P''. But this effect is one hundred and twenty times the power, and therefore the weight would be six hundred times the power.

In the same manner the effect of any compound system of levers may be ascertained by taking the proportion of the weight to the power in each lever separately, and multiplying these numbers together. In the example given, these proportions are 10, 12, and 5, which, multiplied together, give 600. In fig. 9, the levers composing the system are of the first kind; but the principles of the calculation will not be altered if they be of the second or third kind, or some of one kind and some of another.

That number which expresses the proportion of the weight to the equilibrating power in any machine we shall call the *power of the machine*. Thus, if, in a lever, a power of one pound support a weight of ten pounds, the power of the machine is *ten*. If a power of 2 lbs. support a weight of 11 lbs., the power of the machine is $5\frac{1}{2}$, 2 being contained in $11\frac{1}{2}$ times.

As the distances of the power and weight from the fulcrum of a lever may be varied at pleasure, and any assigned proportion given to them, a lever may always be conceived having a power equal to that of any given machine. Such a lever may be called, in relation to that machine, the *equivalent lever*.

As every complex machine consists of a number of simple machines acting one upon another, and as each simple machine may be represented by an equivalent lever, the complex machine will be represented by a compound system of equivalent levers. From what has been proved in fig. 9, it therefore follows that the power of a complex machine may be calculated by multiplying together the powers of the several simple machines of which it is composed.

WHEELWORK.

When a lever is applied to raise a weight, or overcome a resistance, the space through which it acts at any one time is small, and the work must be accomplished by a succession of short and intermitting efforts. In fig. 4, after the weight has been raised from W to W' , the lever must again return to its first position, to repeat the action. During this return the motion of the weight is suspended, and it will fall downward unless some provision be made to sustain it. The common lever is, therefore, only used in cases where weights are required to be raised through small spaces, and under these circumstances its great simplicity strongly recommends it. But where a continuous motion is to be produced, as in raising ore from the mine, or in weighing the anchor of a vessel, some contrivance must be adopted to remove the intermitting action of the lever, and render it continual. The various forms given to the lever, with a view to accomplish this, are generally denominated the *wheel and axle*.

In fig. 10, $A B$ is a horizontal axle, which rests in pivots at its extremities,

Fig. 10.

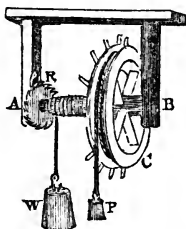

or is supported in gudgeons, and capable of revolving. Round this axis a rope is coiled, which sustains the weight W . On the same axis a wheel, C , is fixed, round which a rope is coiled in a contrary direction, to which is appended the power P . The moment of the power is found by multiplying it by the radius of a wheel, and the moment of the weight by multiplying it by the radius of its axle. If these moments be equal, the machine will be in equilibrium. Whence it appears that the power of the machine is expressed by the proportion which the radius of the wheel bears to the radius of the axle; or, what is the same, of the diameter of the wheel to the diameter of the axle. This principle is applicable to the wheel and axle in every variety of form under which it can be presented.

It is evident that, as the power descends continually, and the rope is uncoiled from the wheel, the weight will be raised continually, the rope by which it is suspended being at the same time coiled upon the axle.

When the machine is in equilibrium, the forces of both the weight and power are sustained by the axle, and distributed between its props, in the manner explained in fig. 7.

When the machine is applied to raise a weight, the velocity with which the power moves is as many times greater than that with which the weight rises, as the weight itself is greater than the power. This is a principle which has already been noticed, and which is common to all machines whatsoever. It may hence be proved that, in the elevation of the weight, a quantity of power is expended equal to that which would be necessary to elevate the weight if the power were immediately applied to it, without the intervention of any machine. This has been explained in the case of the lever, and may be explained in the present instance in nearly the same words.

In one revolution of the machine the length of rope uncoiled from the wheel is equal to the circumference of the wheel, and through this space the power must therefore move. At the same time the length of rope coiled upon the axle is equal to the circumference of the axle, and through this space the weight must be raised. The spaces, therefore, through which the power and weight move in the same time, are in the proportion of the circumferences of the wheel and axle; but these circumferences are in the same proportion as their diameters. Therefore the velocity of the power will bear to the velocity of the weight the same proportion as the diameter of the wheel bears to the diameter of the axle, or, what is the same, as the weight bears to the power.

We have here omitted the consideration of the thickness of the rope. When this is considered, the force must be conceived as acting in the direction of the centre of the rope, and therefore the thickness of the rope which supports the power ought to be added to the diameter of the wheel, and the thickness of the rope which supports the weight to the diameter of the axle. It is the more necessary to attend to this circumstance, as the strength of the rope necessary to support the weight causes its thickness to bear a considerable proportion to the diameter of the axle; while the rope which sustains the power not requiring the same strength, and being applied to a larger circle, bears a very inconsiderable proportion to its diameter.

In numerous forms of the wheel and axle, the weight or resistance is applied by a rope coiled upon the axle; but the manner in which the power is applied is very various, and not often by means of a rope. The circumference of a wheel sometimes carries projecting pins, as represented in fig. 10, to which the hand is applied to turn the machine. An instance of this occurs in the wheel used in the steerage of a vessel.

In the common *windlass* the power is applied by means of a *winch*, which is a rectangular lever, as represented in fig. 11. The arm B C of the winch

Fig. 11.

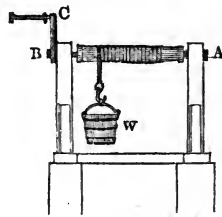

represents the radius of the wheel, and the power is applied to C D at right angles to B C.

In some cases no wheel is attached to the axle; but it is pierced with holes directed toward its centre, in which long levers are incessantly inserted, and a continuous action produced by several men working at the same time; so that, while some are transferring the levers from hole to hole, others are working the windlass.

The axle is sometimes placed in a vertical position, the wheel or levers being moved horizontally. The *capstan* is an example of this: a vertical axis is fixed in the deck of the ship; the circumference is pierced with holes presented toward its centre. These holes receive long levers, as represented in fig. 12. The men who work the capstan walk continually round the axle, pressing forward the levers near their extremities.

In some cases the wheel is turned by the weight of animals placed at its circumference, who move forward as fast as the wheel descends, so as to main-

Fig. 12.

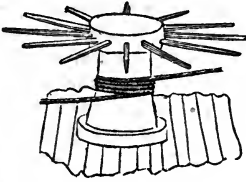
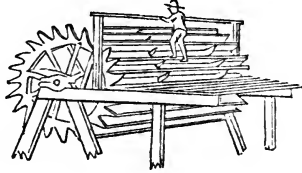
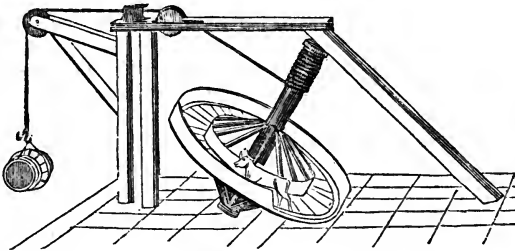

Fig. 13.



tain their position continually at the extremity of the horizontal diameter. The treadmill, fig. 13, and certain cranes, such as fig. 14, are examples of this.

Fig. 14.



In water-wheels, the power is the weight of water contained in buckets at the circumference, as in fig. 15, which is called an overshot wheel; and sometimes the impulse of water against float-boards at the circumference, as in the

Fig. 15.



Fig. 16.

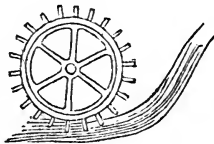
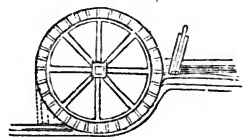

Fig. 17.



undershot wheel, fig. 16. Both these principles act in the breast-wheel, fig. 17.

In the paddle-wheel of a steamboat, the power is the resistance which the water offers to the motion of the paddle-boards.

In windmills, the power is the force of the wind acting on various parts of the arms, and may be considered as different powers simultaneously acting on different wheels having the same axle.

In most cases in which the wheel and axle is used, the action of the power is liable to occasional suspension or intermission, in which case some contrivance is necessary to prevent the recoil of the weight. A ratchet-wheel, R, fig. 10, is provided for this purpose, which is a contrivance which permits the wheel to turn in one direction; but a catch which falls between the teeth of a fixed wheel prevents its motion in the other direction. The effect of the power or weight is sometimes transmitted to the wheel or axle by means of a straight

bar, on the edge of which teeth are raised, which engage themselves in corresponding teeth on the wheel or axle. Such a bar is called a rack; and an instance of its use may be observed in the manner of working the pistons of an air-pump.

The power of the wheel and axle being expressed by the number of times the diameter of the axle is contained in that of the wheel, there are obviously only two ways by which this power may be increased, viz., either by diminishing the diameter of the axle, or increasing that of the wheel. In cases where great power is required, each of these methods is attended with practical inconvenience and difficulty. If the diameter of the wheel be considerably enlarged, the machine will become unwieldy, and the power will work through an unmanageable space. If, on the other hand, the power of the machine be increased by reducing the thickness of the axle, the strength of the axle will become insufficient for the support of that weight, the magnitude of which had rendered the increase of the power of the machine necessary. To combine the requisite strength with moderate dimensions and great mechanical power is, therefore, impracticable in the ordinary form of the wheel and axle. This has, however, been accomplished by giving different thicknesses to different parts of the axle, and carrying a rope, which is coiled on the thinner part, through a wheel attached to the weight, and coiling it in the opposite direction on the thicker part, as in fig. 18. To investigate the proportion of the power

Fig. 18.

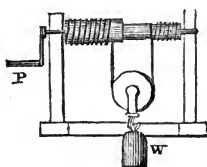
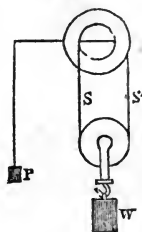

Fig. 19.



to the weight in this case, let fig. 19 represent a section of the apparatus at right angles to the axis. The weight is equally suspended by the two parts of the rope, S and S' , and therefore each part is stretched by a force equal to half the weight. The moment of the force which stretches the rope S is half the weight multiplied by the radius of the thinner part of the axle. This force, being at the same side of the centre with the power, co-operates with it in supporting the force which stretches S' , and which acts at the other side of the centre. The moments of P and S are equal to that of S' ; and therefore, if P be multiplied by the radius of the wheel, and added to half the weight multiplied by the radius of the thinner part of the axle, we must obtain a sum equal to half the weight multiplied by the radius of the thicker part of the axle. Hence it is easy to perceive, that the power multiplied by the radius of the wheel is equal to half the weight multiplied by the difference of the radii of the thicker and thinner parts of the axle; or, what is the same, the power multiplied by the diameter of the wheel is equal to the weight multiplied by half the difference of the diameters of the thinner and thicker parts of the axle.

A wheel and axle constructed in this manner is equivalent to an ordinary one, in which the wheel has the same diameter, and whose axle has a diameter equal to half the difference of the diameters of the thicker and thinner parts. The power of the machine is expressed by the proportion which the diameter of the wheel bears to half the difference of these diameters; and

therefore this power, when the diameter of the wheel is given, does not, as in the ordinary wheel and axle, depend on the smallness of the axle, but on the smallness of the difference of the thinner and thicker parts of it. The axle may, therefore, be constructed of such a thickness as to give it all the requisite strength, and yet the difference of the diameters of its different parts may be so small as to give it all the requisite power.

It often happens that a varying weight is to be raised, or resistance overcome, by uniform power. If, in such a case, the weight be raised by a rope coiled upon a uniform axle, the action of the power would not be uniform, but would vary with the weight. It is, however, in most cases desirable or necessary that the weight or resistance, even though it vary, shall be moved uniformly. This will be accomplished if by any means the leverage of the weight is made to increase in the same proportion as the weight diminishes, and to diminish in the same proportion as the weight increases; for in that case the moment of the weight will never vary, whatever it gains by the increase of weight being lost by the diminished leverage, and whatever it loses by the diminished weight being gained by the increased leverage. An axle, the surface of which is curved in such a manner that the thickness on which the rope is coiled continually increases or diminishes in the same proportion as the weight or resistance diminishes or increases, will produce this effect.

It is obvious that all that has been said respecting a variable weight or resistance is also applicable to a variable power, which, therefore, may, by the same means, be made to produce a uniform effect. An instance of this occurs in a watch, which is moved by a spiral spring. When the watch has been wound up, this spring acts with its greatest intensity, and, as the watch goes down, the elastic force of the spring gradually loses its energy. This spring is connected by a chain with an axle of varying thickness, called a *fusee*. When the spring is at its greatest intensity, the chain acts upon the thinnest part of the fusee, and, as it is uncoiled, it acts upon a part of the fusee which is continually increasing in thickness, the spring at the same time losing its elastic power in exactly the same proportion. A representation of the fusee, and the cylindrical box which contains the spring, is given in fig. 20, and of the spring itself in fig. 21.

Fig. 20.

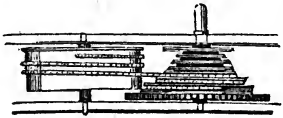

Fig. 21.



When great power is required, wheels and axles may be combined in a manner analogous to a compound system of levers, explained in fig. 9. In this case the power acts on the circumference of the first wheel, and its effect is transmitted to the circumference of the first axle. That circumference is placed in connexion with the circumference of the second wheel, and the effect is thereby transmitted to the circumference of the second axle, and so on. It is obvious, from what was there shown, that the power of such a combination of wheels and axles will be found by multiplying together the powers of the several wheels of which it is composed. It is sometimes convenient to compute this power by numbers, expressing the proportions of the circumferences or diameters of the several wheels, to the circumferences or diameters of the several axles respectively. This computation is made by first multiplying the numbers together which express the circumferences or diameters of the wheels,

and then multiplying together the numbers which express the circumferences or diameters of the several axles. The proportion of the two products will express the power of the machine. Thus, if the circumferences or diameters be as the numbers 10, 14, and 15, their product will be 2,100; and if the circumferences or diameters of the axles be expressed by the numbers 3, 4, and 5, their product will be 60, and the power of the machine will be expressed by the proportion of 2,100 and 60, or 35 to 1.

The manner in which the circumferences of the axles act upon the circumferences of the wheels in compound wheelwork is various. Sometimes a strap or cord is applied to a groove in the circumference of the axle, and carried round a similar groove in the circumference of the succeeding wheel. The friction of this cord or strap with the groove is sufficient to prevent its sliding, and to communicate the force from the axle to the wheel, or *vice versâ*. This method of connecting wheelwork is represented in fig. 22.

Fig. 22.

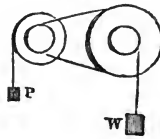

Numerous examples of wheels and axles driven by straps or cords occur in machinery, applied to almost every department of the arts and manufactures. In the turning-lathe, the wheel worked by the treddle is connected with the mandrel by a catgut cord passing through grooves in the wheel and axle. In all great factories revolving shafts are carried along the apartments, on which, at certain intervals, straps are attached, passing round their circumferences, and carried round the wheels which give motion to the several machines. If the wheels, connected by straps or cords, are required to revolve in the same direction, these cords are arranged as in fig. 22; but if they are required to revolve in contrary directions, they are applied as in fig. 23.

Fig. 23.

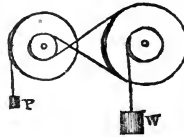

One of the chief advantages of the method of transmitting motion between wheels and axles by straps or cords is, that the wheel and axle may be placed at any distance from each other which may be found convenient, and may be made to turn either in the same or contrary directions.

When the circumference of the wheel acts immediately on the circumference of the succeeding axle, some means must necessarily be adopted to prevent the wheel from moving in contact with the axle without compelling the latter to turn. If the surfaces of both were perfectly smooth, so that all friction were removed, it is obvious that either would slide over the surface of the other without communicating motion to it. But, on the other hand, if there were any asperities, however small, upon these surfaces, they would become mutually inserted among each other, and neither the wheel nor axle could move without causing the asperities with which its edge is studded to encoun-

ter those asperities which project from the surface of the other ; and thus, until these projections should be broken off, both wheel and axle must be moved at the same time. It is on this account that, if the surfaces of the wheels and axles are by any means rendered rough, and pressed together with sufficient force, the motion of either will turn the other, provided the load or resistance be not greater than the force necessary to break off these small projections which produce the friction.

In cases where great power is not required, motion is communicated in this way through a train of wheelwork, by rendering the surface of the wheel and axle rough, either by facing them with buff leather, or with wood cut across the grain. This method is sometimes used in spinning machinery, where one large buffed wheel, placed in a horizontal position, revolves in contact with several small buffed rollers, each roller communicating motion to a spindle. The position of the wheel W, and the rollers R R, &c., are represented in fig. 24. Each roller can be thrown out of contact with the wheel, and restored to it at pleasure.

The communication of motion between wheels and axles by friction has the advantage of great smoothness and evenness, and of proceeding with little noise ; but this method can only be used in cases where the resistance is not very considerable, and therefore is seldom adopted in works on a large scale. Dr. Gregory mentions an instance of a sawmill at Southampton, England, where

Fig. 24.

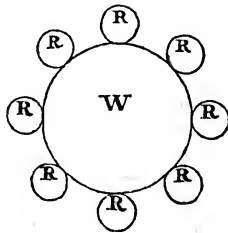

the wheels act upon each other by the contact of the end grain of wood. The machinery makes very little noise, and wears very well, having been used not less than twenty years.

The most usual method of transmitting motion through a train of wheelwork is by the formation of teeth upon their circumferences, so that these indentures of each wheel fall between the corresponding ones of that in which it works, and insure the action so long as the strain is not so great as to fracture the tooth.

In the formation of teeth, very minute attention must be given to their figure, in order that the motion may be communicated from wheel to wheel with smoothness and uniformity. This can only be accomplished by shaping the teeth according to curves of a peculiar kind, which mathematicians have invented, and assigned rules for drawing. The ill consequences of neglecting this will be very apparent, by considering the nature of the action which would be produced if the teeth were formed of square projecting pins, as in fig. 25. When the tooth A comes into contact with B, it acts obliquely upon it, and, as it moves, the corner of B slides upon the plane surface of A in such a manner as to produce much friction, and to grind away the side of A and the end of B. As they approach the position C D, they sustain a jolt the moment their sur-

faces come into full contact; and after passing the position of C D, the same scraping and grinding effect is produced in the opposite direction, until, by the

Fig. 25.

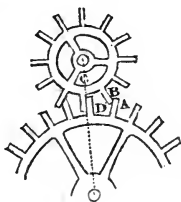

revolution of the wheels, the teeth become disengaged. These effects are avoided by giving to the teeth the curved forms represented in fig. 26. By

Fig. 26.

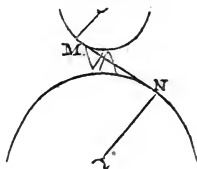

such means the surfaces of the teeth roll upon each other with very inconsiderable friction, and the direction in which the pressure is excited is always that of a line, M N, touching the two wheels, and at right angles to the radii. Thus the pressure, being always the same, and acting with the same leverage, produces a uniform effect.

When wheels work together, their teeth must necessarily be of the same size, and therefore the proportion of their circumferences may always be estimated by the number of teeth which they carry. Hence it follows that, in computing the power of compound wheelwork, the number of teeth may always be used to express the circumferences respectively, or the diameters which are proportional to these circumferences. When teeth are raised upon an axle, it is generally called a *pinion*, and in that case the teeth are called *leaves*. The rule for computing the train of wheelwork, given in fig. 9, will be expressed as follows: When the wheel and axle carry teeth, multiply together the number of teeth in each of the wheels, and next the number of leaves in each of the pinions; the proportion of the two products will express the power of the machine. If some of the wheels and axles carry teeth, and others not, this computation may be made by using for those circumferences which do not bear teeth the number of teeth which would fill them. Fig. 27 represents a train of three wheels and pinions. The wheel F, which bears the power, and the axle which bears the weight, have no teeth; but it is easy to find the number of teeth which they would carry.

It is evident that each pinion revolves much more frequently in a given time than the wheel which it drives. Thus, if the pinion C be furnished with ten teeth, and the wheel E, which it drives, have sixty teeth, the pinion C must turn six times, in order to turn the wheel E once round. The velocities of revolution of every wheel and pinion which work in one another will, therefore, have the same proportion as their number of teeth taken in a reverse or-

der, and by this means the relative velocity of wheels and pinions may be determined according to any proposed rate.

Wheelwork, like all other machinery, is used to transmit and modify force

Fig. 27.

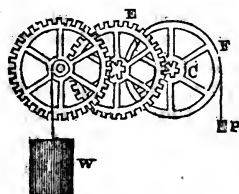

in every department of the arts and manufactures; but it is also used in cases where motion alone, and not force, is the object to be attained. The most remarkable example of this occurs in watch and clock work, where the object is merely to produce uniform motions of rotation, having certain proportions, and without any regard to the elevation of weights, or the overcoming of resistances.

A *crane* is an example of combination of wheelwork used for the purpose of raising or lowering great weights. Fig. 28 represents a machine of this kind.

Fig. 28.

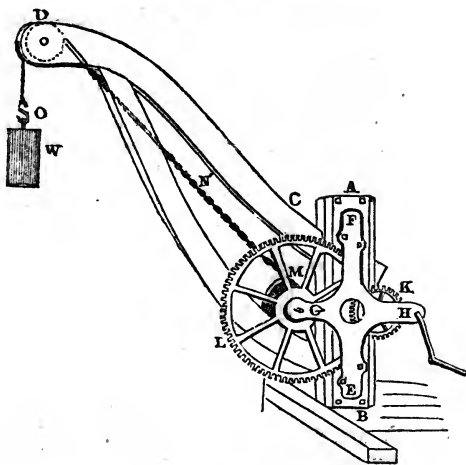

A B is a strong vertical beam, resting on a pivot, and secured in its position by beams in the floor. It is capable, however, of turning on its axis, being confined between rollers attached to the beams and fixed in the floor. C D is a projecting arm, called a *gib*, formed of beams which are mortised into A B. The wheelwork is mounted in two cast-iron crosses, bolted on each side of the beams, one of which appears at E F G H. The winch at which the power is applied is at I. This carries a pinion immediately behind H. This pinion works in a wheel, K, which carries another pinion upon its axle. This last pinion works in a larger wheel, L, which carries upon its axis a barrel, M, on

which a chain or rope is coiled. The chain passes over a pulley, D, at the top of the gib. At the end of the chain a hook, O, is attached, to support the weight W. During the elevation of the weight, it is convenient that its recoil should be hindered in case of any occasional suspension of the power. This is accomplished by a ratchet-wheel attached to the barrel M, as illustrated in fig. 10; but when the weight W is to be lowered, the catch must be removed from this ratchet-wheel. In this case, the too-rapid descent of the weight is in some cases checked by pressure excited on some part of the wheelwork, so as to produce sufficient friction to retard the descent in any required degree, or even to suspend it, if necessary. The vertical beam at B resting on a pivot, and being fixed between rollers, allows the gib to be turned round in any direction; so that a weight raised from one side of the crane may be carried round and deposited on another side, at any distance within the range of the gib. Thus, if a crane be placed upon a wharf near a vessel, weights may be raised, and, when elevated, the gib may be turned round so as to let them descend into the hold.

The power of this machine may be computed upon the principles already explained. The magnitude of the circle, in which the power at I moves, may be determined by the radius of the winch, and therefore the number of teeth which a wheel of that size would carry may be found. In like manner, we may determine the number of leaves in a pinion whose magnitude would be equal to the barrel M. Let the first number be multiplied by the number of teeth in the wheel K, and that product by the number of teeth in the wheel L. Next, let a number of leaves in the pinion H be multiplied by the number of leaves in the pinion attached to the axle of the wheel K, and let that product be multiplied by the number of leaves in a pinion whose diameter is equal to that of the barrel M. These two products will express the power of the machine.

Toothed wheels are of three kinds, distinguished by the position which the teeth bear with respect to the axis of the wheel. When they are raised upon the edge of the wheel, as in fig. 27, they are called *spur wheels*, or *spur gear*. When they are raised parallel to the axis, as in fig. 29, it is called a *crown*

Fig. 29.



wheel. When the teeth are raised on a surface inclined to the plane of the wheel, as in fig. 30, they are called *bevelled wheels*.

Fig. 30.

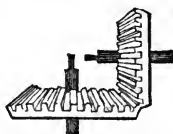

If a motion round one axis is to be communicated to another axis parallel to

it, spur gear is generally used. Thus, in fig. 27, the three axes are parallel to each other. If a motion round one axis is to be communicated to another at right angles to it, a crown wheel, working in a spur pinion, as in fig. 29, will serve; or the same object may be obtained by two bevelled wheels, as in fig. 30.

If a motion round one axis is required to be communicated to another inclined to it at any proposed angle, two bevelled wheels can always be used. In fig. 31, let A B and A C be the two axes; two bevelled wheels, such as

Fig. 31.

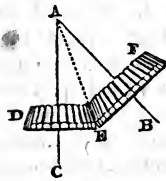

D E and E F, on these axes will transmit the motion or rotation from one to the other, and the relative velocity may, as usual, be regulated by the proportional magnitude of the wheels.

In order to equalize the wear of the teeth of a wheel and pinion, which work in one another, it is necessary that every leaf of the pinion should work in succession through every tooth of the wheel, and not continually act upon the same set of teeth. If the teeth could be accurately shaped according to mathematical principles, and the materials of which they are formed be perfectly uniform, this precaution would be less necessary; but, as slight inequalities, both of material and form, must necessarily exist, the effects of these should be as far as possible equalized, by distributing them through every part of the wheel. For this purpose, it is usual, especially in millwork, where considerable force is used, so to regulate the proportion of the number of teeth in the wheel and pinion, that the same leaf of the pinion shall not be engaged twice with any one tooth of the wheel until after the action of a number of teeth, expressed by the product of the number of teeth in the wheel and pinion. Let us suppose that the pinion contains ten leaves, which we shall denominate by the numbers 1, 2, 3, &c., and that the wheel contains 60 teeth similarly denominated. At the commencement of the motion, suppose the leaf 1 of the pinion engages the tooth 1 of the wheel; then, after one revolution, the leaf 1 of the pinion will engage the tooth 11 of the wheel, and after two revolutions the leaf 1 of the pinion will engage the tooth 21 of the wheel, and in like manner, after three, four, and five revolutions of the pinion, the leaf 1 will engage successively the teeth 31, 41, and 51 of the wheel. After the sixth revolution, the leaf 1 of the pinion will engage the tooth 1 of the wheel. Thus it is evident that, in the case here supposed, the leaf 1 of the pinion will continually be engaged with the teeth 1, 11, 21, 31, 41, and 51 of the wheel, and no others. The like may be said of every leaf of the pinion. Thus the leaf 2 of the pinion will be successively engaged with the teeth 2, 12, 22, 32, 42, and 52 of the wheel, and no others. Any accidental inequalities of these teeth will therefore continually act upon each other, until the circumference of the wheel be divided into parts of ten teeth each, unequally worn. This effect would be avoided by giving either the wheel or pinion one tooth more or one tooth less. Thus, suppose the wheel, instead of having 60 teeth, had 61, then, after six revolutions of the pinion, the leaf 1 of the pinion would be engaged with the

tooth 61 of the wheel; and, after one revolution of the wheel, the leaf 2 of the pinion would be engaged with the tooth 1 of the wheel. Thus, during the first revolution of the wheel, the leaf 1 of the pinion would be successively engaged with the teeth 1, 11, 21, 31, 41, 51, and 61 of the wheel; at the commencement of the second revolution of the wheel the leaf 2 of the pinion would be engaged with the tooth 1 of the wheel; and, during the second revolution of the wheel, the leaf 1 of the pinion would be successively engaged with the teeth 10, 20, 30, 40, 50, and 60 of the wheel. In the same manner it may be shown that, in the third revolution of the wheel, the leaf 1 of the pinion would be successively engaged with the teeth 9, 19, 29, 39, 49, and 59 of the wheel; during the fourth revolution of the wheel, the leaf 1 of the pinion would be successively engaged with the teeth 8, 18, 28, 38, 48, and 58 of the wheel. By continuing this reasoning it will appear that, during the tenth revolution of the wheel, the leaf 1 of the pinion will be engaged successively with the teeth 2, 12, 22, 32, 42, and 52 of the wheel. At the commencement of the eleventh revolution of the wheel the leaf 1 of the pinion will be engaged with the tooth 1 of the wheel, as at the beginning of the motion. It is evident, therefore, that, during the first ten revolutions of the wheel, each leaf of the pinion has been successively engaged with every tooth of the wheel, and that during these ten revolutions the pinion has revolved 61 times. Thus the leaves of the pinion have acted 610 times upon the teeth of the wheel, before two teeth can have acted twice upon each other.

The odd tooth which produces this effect is called by millwrights the *hunting-cog*.

The most familiar case in which wheelwork is used to produce and regulate motion merely, without any reference to weights to be raised or resistances to be overcome, is that of chronometers. In watch and clock work, the object is to cause a wheel to revolve with a uniform velocity, and at a certain rate. The motion of this wheel is indicated by an index or hand placed upon its axis, and carried round with it. In proportion to the length of the hand, the circle over which its extremity plays is enlarged, and its motion becomes more perceptible. This circle is divided, so that very small fractions of a revolution of the hand may be accurately observed. In most chronometers it is required to give motion to two hands, and sometimes to three. These motions proceed at different rates, according to the subdivisions of time generally adopted. One wheel revolves in a minute, bearing a hand which plays round a circle divided into sixty equal parts; the motion of the hand over each part indicating one second, and a complete revolution of the hand being performed in one minute. Another wheel revolves once, while the former revolves sixty times; consequently the hand carried by this wheel revolves once in sixty minutes, or one hour. The circle on which it plays is, like the former, divided into sixty equal parts, and the motion of the hand over each division is performed in one minute. This is generally called the *minute hand*, and the former the *second hand*.

A third wheel revolves once, while that which carries the minute hand revolves twelve times; consequently this last wheel, which carries the *hour hand*, revolves at a rate twelve times less than that of the minute hand, and therefore seven hundred and twenty times less than the second hand. We shall now endeavor to explain the manner in which these motions are produced and regulated. Let A, B, C, D, E, fig. 32, represent a train of wheels, and *a, b, c, d*, represent their pinions, *e* being a cylinder on the axis of the wheel E, round which a rope is coiled, sustaining a weight, W. Let the effect of this weight, transmitted through the train of wheels, be opposed by a power, P, acting upon the wheel A, and let this power be supposed to be of such a nature as to cause

the weight *W* to descend with a uniform velocity, and at any proposed rate. The wheel *E* carries on its circumference eighty-four teeth. The wheel *D* carries eighty teeth; the wheel *C* is also furnished with eighty teeth, and the

Fig. 32.

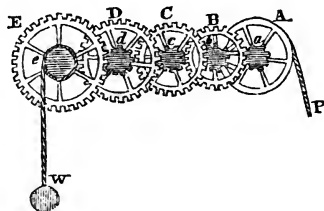

wheel *B* with seventy-five. The pinions *d* and *c* are each furnished with twelve leaves, and the pinions *b* and *a* with ten.

If the power at *P* be so regulated as to allow the wheel *A* to revolve once in a minute, with a uniform velocity, a hand attached to the axis of this wheel will serve as the *second hand*. The pinion *a*, carrying ten teeth, must revolve seven times and a half to produce one revolution of *B*, consequently fifteen revolutions of the wheel *A* will produce two revolutions of the wheel *B*; the wheel *B* therefore revolves twice in fifteen minutes. The pinion *b* must revolve eight times to produce one revolution of the wheel *C*, and therefore the wheel *C* must revolve once in four quarters of an hour, or in one hour. If a hand be attached to the axis of this wheel, it will have the motion necessary for the minute hand. The pinion *c* must revolve six and two thirds times to produce one revolution of the wheel *D*, and therefore this wheel must revolve once in six and two thirds hours. The pinion *d* revolves seven times for one revolution of the wheel *E*, and therefore the wheel *E* will revolve once in forty-six and two thirds hours.

On the axis of the wheel *C* a second pinion may be placed, furnished with seven leaves, which may lead a wheel of eighty-four teeth, so that this wheel shall turn once during twelve turns of the wheel *C*. If a hand be fixed upon the axis, this hand will revolve once for twelve revolutions of the minute hand fixed upon the axis of the wheel *C*; that is, it will revolve once in twelve hours. If it play upon a dial divided into twelve equal parts, it will move over each part in an hour, and will serve the purpose of the hour hand of the chronometer.

We have here supposed that the second hand, the minute hand, and the hour hand, move on separate dials. This, however, is not necessary. The axis of the hour hand is commonly a tube, enclosing within it that of the minute hand, so that the same dial serves for both. The second hand, however, is generally furnished with a separate dial.

We shall now explain the manner in which a power is applied to the wheel *A*, so as to regulate and equalize the effect of the weight *W*. Suppose the wheel *A* furnished with thirty teeth, as in fig. 33; if nothing check the motion, the weight *W* would descend with an accelerated velocity, and would communicate an accelerated motion to the wheel *A*. This effect, however, is interrupted by the following contrivance: *L M* is a pendulum vibrating on the centre *L*, and so regulated that the time of its oscillation is one second. The pallets *I* and *K* are connected with the pendulum, so as to oscillate with it. In the position of the pendulum represented in the figure, the pallet *I* stops the motion of the wheel *A*, and entirely suspends the action of the weight *W*,

fig. 32, so that for a moment the entire machine is motionless. The weight M, however, falls by its gravity toward the lowest position, and disengages the pallet I from the tooth of the wheel. The Weight W begins then to take ef-

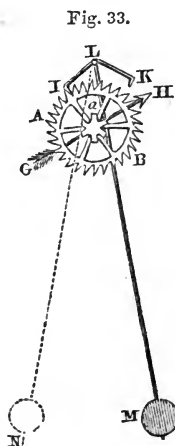

fect, and the wheel A turns from A toward B. Meanwhile the pendulum M oscillates to the other side, and the pallet K falls under a tooth of the wheel A, and checks for a moment its further motion. On the returning vibration, the pallet K becomes again disengaged, and allows the tooth of the wheel to escape, and by the influence of the weight W another tooth passes before the motion of the wheel A is again checked by the interposition of the pallet I.

From this explanation it will appear that, in two vibrations of the pendulum, one tooth of the wheel A passes the pallet I, and therefore, if the wheel A be furnished with 30 teeth, it will be allowed to make one revolution during 60 vibrations of the pendulum. If, therefore, the pendulum be regulated so as to vibrate seconds, this wheel will revolve once in a minute. From the action of the pallets in checking the motion of the wheel A, and allowing its teeth alternately to *escape*, this has been called the *escapement* wheel; and the wheel and pallets together are generally called the *escapement*, or *'scapement*.

We have already explained that, by reason of the friction on the points of support, and other causes, the swing of the pendulum would gradually diminish, and its vibration at length cease. This, however, is prevented by the action of the teeth of the 'scapement wheel upon the pallets, which is just sufficient to communicate that quantity of force to the pendulum which is necessary to counteract the retarding effects, and to maintain its motion. It thus appears that, although the effect of the gravity of the weight W in giving motion to the machine is at intervals suspended, yet this part of the force is not lost, being, during these intervals, employed in giving to the pendulum all that motion which it would lose by the resistances to which it is inevitably exposed.

In stationary clocks, and in other cases in which the bulk of the machine is not an objection, a descending weight is used as the moving power. But in watches and portable chronometers, this would be attended with evident inconvenience. In such cases, a spiral spring, called the *main-spring*, is the mov-

ing power. The manner in which this spring communicates rotation to an axis, and the ingenious method of equalizing the effect of its variable elasticity by giving to it a leverage, which increases as the elastic force diminishes, has been already explained.

A similar objection lies against the use of a pendulum in portable chronometers. A spiral spring of a similar kind, but infinitely more delicate, called a *hair-spring*, is substituted in its place. This spring is connected with a nicely-balanced wheel, called the *balance-wheel*, which plays in pivots. When this wheel is turned to a certain extent in one direction, the hair-spring is coiled up, and its elasticity causes the wheel to recoil, and return to a position in which the energy of the spring acts in the opposite direction. The balance wheel then returns, and continually vibrates in the same manner. The axis of this wheel is furnished with pallets similar to those of the pendulum, which are alternately engaged with the teeth of a crown wheel, which takes the place of the 'scapement wheel already described.

A general view of the work of a common watch is represented in fig. 34.

Fig. 34.

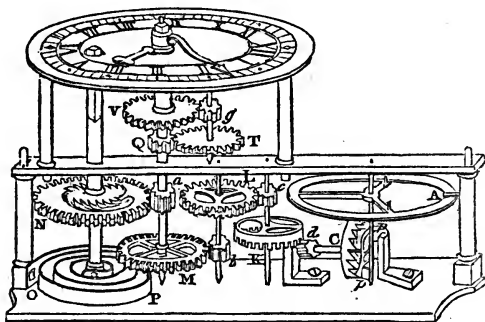

A is the balance wheel, bearing pallets *p p* upon its axis; C is the crown wheel, whose teeth are suffered to escape alternately by those pallets in the manner already described in the 'scapement of a clock. On the axis of the crown wheel is placed a pinion, *d*, which drives another crown wheel, K. On the axis of this is placed the pinion *c*, which plays in the teeth of the third wheel L. The pinion *b*, on the axis of L, is engaged with the wheel M, called the *centre wheel*. The axle of this wheel is carried up through the centre of the dial. A pinion, *a*, is placed upon it, which works in the great wheel N. On this wheel the main-spring immediately acts. O P is the main-spring stripped of its barrel. The axis of the wheel M, passing through the centre of the dial, is squared at the end to receive the minute-hand. A second pinion, Q, is placed upon this axle, which drives a wheel, T. On the axle of this wheel a pinion, *g*, is placed, which drives the hour-wheel V. This wheel is placed upon a tubular axis, which encloses within it the axis of the wheel M. This tubular axis, passing through the centre of the dial, carries the hour-hand.

The wheels A, B, C, D, E, fig. 32, correspond to the wheels C, K, L, M, N, fig. 34; and the pinions *a, b, c, d, e*, fig. 32, correspond to the pinions *d, c, b, a*, fig. 34. From what has already been explained of these wheels, it will be obvious that the wheel M, fig. 34, revolves once in an hour, causing the minute-hand to move round the dial once in that time. This wheel at the same time turns the pinion Q, which leads the wheel T. This wheel again

turns the pinion g , which leads the hour wheel V . The leaves and teeth of these pinions and wheels are proportioned, as already explained, so that the wheel V revolves once during twelve revolutions of the wheel M . The hour-hand, therefore, which is carried by the tubular axle of the wheel V , moves once round the dial in twelve hours.

Our object here has not been to give a detailed account of watch and clock work. Such a general account has only been attempted as may explain how tooth-and-pinion work may be applied to regulate motion.

THE PULLEY.

**Cord.—Sheave.—Fixed Pulley.—Fire-Escapes.—Single moveable Pulley.—Systems of Pulleys.—
Smeaton's Tackle.—White's Pulley.—Advantage of.—Runner.—Spanish Bartons.**

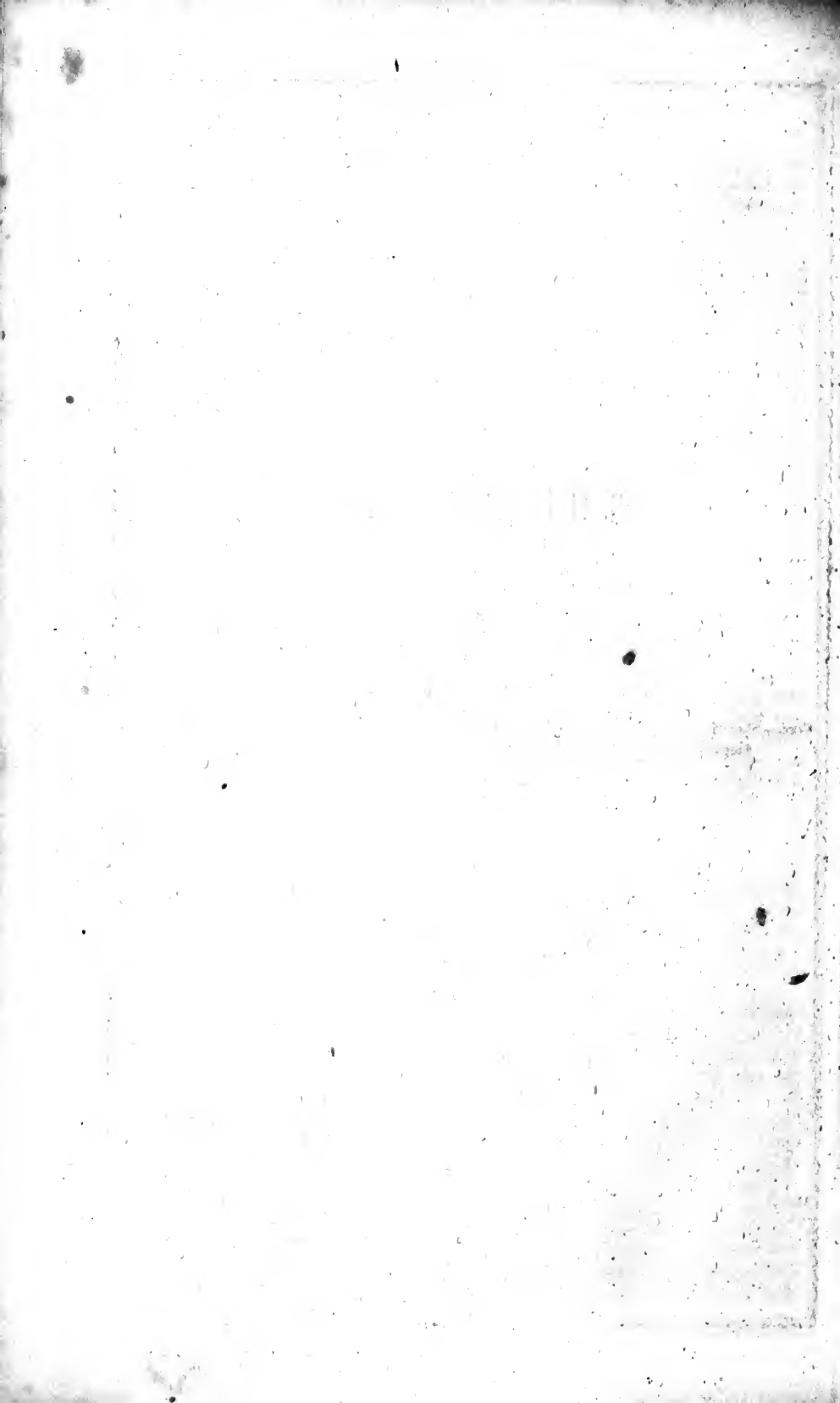

THE PULLEY.

THE class of simple machines which present themselves to our attention at this time, is that which is called the *cord*. If a rope were perfectly flexible, and were capable of being bent over a sharp edge, and of moving upon it without friction, we should be enabled by its means to make a force in any one direction overcome resistance, or communicate motion in any other direction. Thus if P, fig. 1, be such an edge, a perfectly flexible rope passing over it would be

Fig. 1.

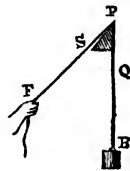

capable of transmitting a force S F to a resistance Q B, so as to support or overcome B, or by a motion in the direction of S F to produce another motion in the direction B Q. But as no materials of which ropes can be constructed can give them perfect flexibility, and as, in proportion to the strength by which they are enabled to transmit force, their rigidity increases, it is necessary, in practice, to adopt means to remove or mitigate those effects which attend imperfect flexibility, and which would otherwise render cords practically inapplicable as machines.

When a cord is used to transmit a force from one direction to another, its stiffness renders some force necessary in bending it over the angle P, which the two directions form; and if the angle be sharp, the exertion of such a force may be attended with the rupture of the cord. If, instead of bending the rope at one point over a single angle, the change of direction were produced by successively deflecting it over several angles, each of which would be less sharp

than a single one could be, the force requisite for the deflection, as well as the liability of rupturing the cord, would be considerably diminished. But this end will be still more perfectly attained if the deflection of the cord be produced by bending it over the surface of a curve.

If a rope were applied only to sustain, and not to move a weight, this would be sufficient to remove the inconveniences arising from its rigidity. But when motion is to be produced, the rope, in passing over the curved surface, would be subject to excessive friction, and consequently to rapid wear. This inconvenience is removed by causing the surface on which the rope runs to move with it, so that no more friction is produced than would arise from the curved surface rolling upon the rope.

All these ends are attained by the common pulley, which consists of a wheel called a *sheave*, fixed in a block and turning on pivots. A groove is formed in the edge of the wheel, in which the rope runs, the wheel revolving with it. Such an apparatus is represented in fig. 2.

Fig. 2.



We shall, for the present, omit the consideration of that part of the effects of the stiffness and friction of the machine which is not removed by the contrivance just explained, and shall consider the rope as perfectly flexible, and moving without friction.

From the definition of a flexible cord, it follows that its tension, or the force by which it is stretched throughout its entire length, must be uniform. From this principle, and this alone, all the mechanical properties of pulleys may be derived.

Although, as already explained, the whole mechanical efficacy of this machine depends on the qualities of the cord, and not on those of the block and sheave, which are only introduced to remove the accidental effects of stiffness and friction, yet it has been usual to give the name *pulley* to the block and sheave, and a combination of blocks, sheaves, and ropes, is called a *tackle*.

When the rope passes over a single wheel, which is fixed in its position, as in fig. 2, the machine is called a *fixed pulley*. Since the tension of the cord is uniform throughout its length, it follows that in this machine the power and weight are equal. For the weight stretches that part of the cord which is between the weight and pulley, and the power stretches that part between the power and the pulley; and since the tension throughout the whole length is the same, the weight must be equal to the power.

Hence it appears that no mechanical advantage is gained by this machine. Nevertheless, there is scarcely any engine, simple or complex, attended with more convenience. In the application of power, whether of men or animals, or arising from natural forces, there are always some directions in which it may be exerted to much greater convenience and advantage than others, and in many cases the exertion of these powers is limited to a single direction. A machine, therefore, which enables us to give the most advantageous direction to the moving power, whatever be the direction of the resistance opposed to it, contributes as much practical convenience as one which enables a small

power to balance or overcome a great weight. In directing the power against the resistance, it is often necessary to use two fixed pulleys. Thus, in elevating a weight A, fig. 3, to the summit of a building, by the strength of a horse moving below, two fixed pulleys, B and C, may be used. The rope is carried from A over the pulley B; the rope passes, and returning downward, is brought under C, and finally drawn by the animal on the horizontal plane. In the same manner sails are spread, and flags hoisted on the yards and masts of a ship, by sailors pulling a rope on the deck.

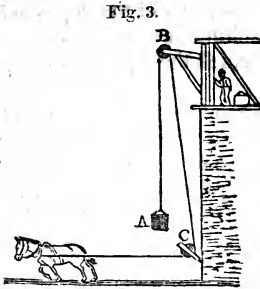

By means of the fixed pulley a man may raise himself to a considerable height, or descend to any proposed depth. If he be placed in a chair or bucket attached to one end of a rope, which is carried over a fixed pulley, by laying hold of this rope on the other side, as represented in fig. 4, he may, at will, descend to a depth equal to half of the entire length of the rope, by continually yielding rope on the one side, and depressing the bucket or chair by his weight on the other. Fire-escapes have been constructed on this principle, the fixed pulley being attached to some part of the building.

A *single moveable pulley* is represented in fig. 5. A cord is carried from a fixed point F, and, passing through a block B, attached to a weight W, passes over a fixed pulley C, the power being applied at P. We shall first suppose the parts of the cord on each side the wheel B to be parallel; in this case, the whole weight W being sustained by the parts of the cords B C and B F, and these parts being equally stretched, each must sustain half the weight, which is therefore the tension of the cord. This tension is resisted by the power at P, which must therefore be equal to half the weight. In this machine, therefore, the weight is twice the power.

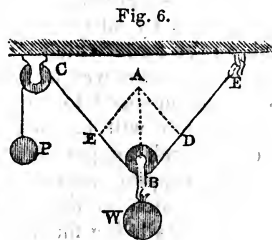

If the parts of the cord B C and B F be not parallel, as in fig. 6, a greater power than half the weight is therefore necessary to sustain it. To determine the power necessary to support a given weight, in this case take the line B A in the vertical direction, consisting of as many inches as the weight consists of ounces; from A draw A D parallel to B C, and A E parallel to B F; the

force of the weight represented by A B will be equivalent to two forces represented by B D and B E. The number of inches in these lines respectively will represent the number of ounces which are equivalent to the tensions of the parts B F and B C of the cord. But as these tensions are equal, B D and B E must be equal, and each will express the amount of the power P, which stretches the cord at P C.

It is evident that the four lines, A E, E B, B D, and D A, are equal. And as each of them represents the power, the weight which is represented by A B must be less than twice the power which is represented by A E and E B taken together. It follows, therefore, that as parts of the ropes which support the weight depart from parallelism, the machine becomes less and less efficacious; and there are certain obliquities at which the equilibrating power would be much greater than the weight.

The mechanical power of pulleys admits of being almost indefinitely increased by combination. Systems of pulleys may be divided into two classes: those in which a single rope is used, and those which consist of several distinct ropes. Figs. 7 and 8, represent two systems of pulleys, each having a

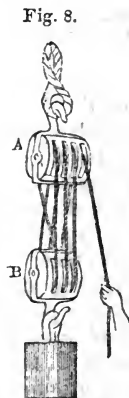
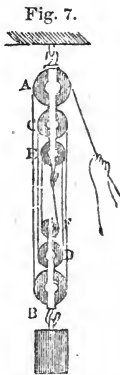

single rope. The weight is in each case attached to a moveable block B, in which are fixed two or more wheels; A is a fixed block, and the rope is successively passed over the wheels above and below, and, after passing over the last wheel above, is attached to the power. The tension of that part of the cord to which the power is attached is produced by the power, and therefore equivalent to it, and the same tension must extend throughout its whole length. The weight is sustained by all those parts of the cord which pass from the lower block, and, as the force which stretches them all is the same, viz., that of the power, the effect of the weight must be equally distributed among them, their directions being supposed to be parallel. It will be evident, from this reasoning, that the weight will be as many times greater than the power, as the number of cords which support the lower block. Thus, if there be six cords, each cord will support a sixth part of the weight—that is, the weight will be six times the tension of the cord, or six times the power. In fig. 7, the cord is represented as being finally attached to a hook on the upper block. But it may be carried over an additional wheel fixed in that block, and finally attached to a hook in the lower block, as in fig. 8, by which one will be added to the power of the machine, the number of cords at the lower block being increased by one. In the system represented in fig. 7, the wheels are placed in the blocks one above the other; in fig. 8 they are placed side by side. In

all systems of pulleys of this class, the weight of the lower block is to be considered as a part of the weight to be raised, and, in estimating the power of the machine, this should always be attended to.

When the power of the machine, and therefore the number of wheels, is considerable, some difficulty arises in the arrangement of the wheels and cords. The celebrated Smeaton contrived a tackle, which takes its name from him, in which there are ten wheels in each block: five large wheels placed side by side, and five smaller ones similarly placed above them in the lower block, and below them in the upper. Fig. 9 represents Smeaton's blocks

Fig. 9



without the rope. The wheels are marked with the numbers 1, 2, 3, &c., in the order in which the rope is to be passed over them. As in this pulley, twenty distinct parts of the rope support the lower block, the weight, including the lower block, will be twenty times the equilibrating power.

In all these systems of pulleys, every wheel has a separate axle, and there is a distinct wheel for every turn of the rope at each block. Each wheel is attended with friction on its axle, and also with friction between the sheave and block. The machine is by this means robbed of a great part of its efficacy, since, to overcome the friction alone, a considerable power is in most cases necessary.

An ingenious contrivance has been suggested, by which all the advantage of a large number of wheels may be obtained without the multiplied friction of distinct sheaves and axles. To comprehend the excellence of this contrivance, it will be necessary to consider the rate at which the rope passes over the several wheels of such a system, as fig. 7. If one foot of the rope G F pass over the pulley F, two feet must pass over the pulley E, because the distance between F and E being shortened one foot, the total length of the rope G F E must be shortened two feet. These two feet of rope must pass in the direction E D; and the wheel D, rising one foot, three feet of rope must consequently pass over it. These three feet of rope passing in the direction D C, and the rope D C being also shortened one foot by the ascent of the lower block, four feet of rope must pass over the wheel C. In the same way it may be shown that five feet must pass over B, and six feet over A. Thus, whatever be the number of wheels in the upper and lower blocks, the parts of the rope which pass in the same time over the wheels in the lower block are in the proportion of the odd numbers 1, 3, 5, &c.; and those which pass over the

wheels in the upper block in the same time, are as the even numbers 2, 4, 6, &c. If the wheels were all of equal size, as in fig. 8, they would revolve with velocities proportional to the rate at which the rope passes over them : so that, while the first wheel below revolves once, the first wheel above will revolve twice ; the second wheel below three times ; the second wheel above four times, and so on. If, however, the wheels differed in size in proportion to the quantity of rope which must pass over them, they would evidently revolve in the same time. Thus, if the first wheel above were twice the size of the first wheel below, one revolution would throw off twice the quantity of rope. Again, if the second wheel below were thrice the size of the first wheel below, it would throw off in one revolution thrice the quantity of rope, and so on. Wheels thus proportioned, revolving in exactly the same time, might be all placed on one axle, and would partake of one common motion, or, what is to the same effect, several grooves might be cut upon the face of one solid wheel, with diameters in the proportion of the odd numbers 1, 3, 5, &c., for the lower pulley, and corresponding grooves on the face of another solid wheel represented by the even numbers 2, 4, 6, &c., for the upper pulley. The rope, being passed successively over the grooves of such wheels, would be thrown off exactly in the same manner as if every groove were upon a separate wheel, and every wheel revolved independently of the others. Such is White's pulley, represented in fig. 10.

Fig. 10.

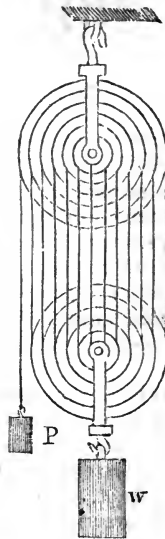

The advantage of this machine, when accurately constructed, is very considerable. The friction, even when great resistances are to be opposed, is very trifling ; but, on the other hand, it has corresponding disadvantages which greatly circumscribe its practical utility. In the workmanship of the grooves, great difficulty is found in giving them the exact proportions ; in doing which, the thickness of the rope must be accurately allowed for ; and consequently it follows that the same pulley can never act, except with a rope of a particular diameter. A very slight deviation from the true proportion of the grooves will cause the rope to be unequally stretched, and will throw on some parts of it an

undue proportion of the weight, while other parts become nearly, and sometimes altogether slack. Besides these defects, the rope is so liable to derangement by being thrown out of the grooves, that the pulley can scarcely be considered portable.

For these and other reasons, this machine, ingenious as it unquestionably is, has never been extensively used.

In the several systems of pulleys just explained, the hook to which the fixed block is attached supports the entire of both the power and weight. When the machine is in equilibrium, the power only supports so much of the weight as is equal to the tension of the cord, all the remainder of the weight being thrown on the fixed point.

If the power be moved so as to raise the weight, it will move with a velocity as many times greater than that of the weight, as the weight itself is greater than the power. Thus in fig. 7, if the weight attached to the lower block ascend one foot, six feet of line will pass over the pulley A, according to what has been already proved. Thus the power will descend through six feet, while the weight rises one foot. But, in this case, the weight is six times the power.

When two or more ropes are used, pulleys may be combined in various ways so as to produce any degree of mechanical effect. If to any of the systems already described, a single moveable pulley be added, the power of the machine would be doubled. In this case, the second rope is attached to the hook of the lower block, as in fig. 11, and, being carried through a moveable pulley

Fig. 11.

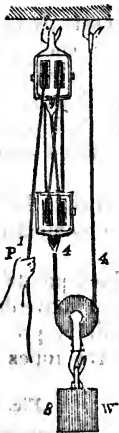
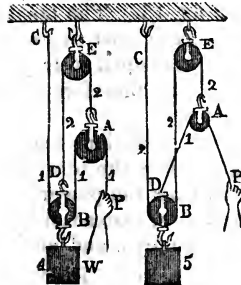

Fig. 12.



attached to the weight, it is finally brought up to a fixed point. The tension of the second cord is equal to half the weight; and therefore the power P, by means of the first cord, will have only half the tension which it would have if the weight were attached to the lower block. A moveable pulley thus applied is called a *runner*.

Two systems of pulleys, called *Spanish bartons*, having each two ropes, are represented in fig. 12. The tension of the rope P A B C in the first system is equal to the power; and therefore the parts B A and B C support a portion of the weight equal to twice the power. The rope E A supports the tensions of A P and A B; and therefore the tension of A E D is twice the power. Thus the united tensions of the ropes which support the pulley B is four times

the power, which is therefore the amount of the weight. In the second system, the rope P A D is stretched by the power. The rope A E B C acts against the united tensions A P and A D; and therefore the tension of A E or E B is twice the power. Thus the weight acts against three tensions: two of which are equal to twice the power, and the remaining one is equal to the power. The weight is therefore equal to five times the power.

A single rope may be so arranged with one moveable pulley as to support a weight equal to three times the power. In fig. 13, this arrangement is represented, where the numbers sufficiently indicate the tension of the rope, and the proportion of the weight and power. In fig. 14, another method of producing the same effect with two ropes is represented.

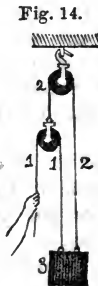
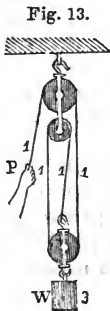

If several single moveable pulleys be made successively to act upon each other, the effect is doubled by every additional pulley: such a system as this is represented in fig. 15. The tension of the first rope is equal to the power; the second rope acts against twice the tension of the first, and therefore it is stretched with a force equal to twice the power; the third rope acts against twice this tension, and therefore it is stretched with a force equal to four times the power, and so on.

In this system, it is obvious that the ropes will require to have different degrees of strength, since the tension to which they are subject increases in a double proportion from the power to the weight.

If each of the ropes, instead of being attached to fixed points at the top, are carried over fixed pulleys, and attached to the several moveable pulleys respectively, as in fig. 16, the power of the machine will be greatly increased; for in that case the forces which stretch the successive ropes increase in a

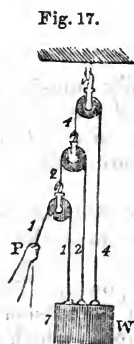
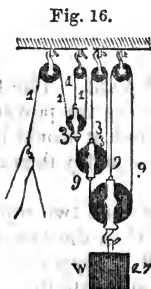

treble instead of a double proportion, as will be evident by attending to the numbers which express the tensions in the figure. One rope would render the weight three times the power; two ropes nine times; three ropes twenty-seven times, and so on. An arrangement of pulleys is represented in fig. 17, by which each rope, instead of being finally attached to a fixed point, as in fig. 15, is attached to the weight. The weight is in this case supported by three ropes: one stretched with a force equal to the power; another with a force equal to twice the power; and a third with a force equal to four times the power. The weight is, therefore, in this case, seven times the power.

If the ropes, instead of being attached to the weight, pass through wheels as in fig. 18, and are finally attached to the pulleys above, the power of the machine will be considerably increased. In the system here represented, the weight is twenty-six times the power.

In considering these several combinations of pulleys, we have omitted to estimate the effects produced by the weights of the sheaves and blocks. Without entering into the details of this computation, it may be observed generally that in the systems represented in figs. 15 and 16, the weight of the wheel and blocks acts against the power; but that in figs. 17 and 18, they assist the power in supporting the weight. In the systems represented in fig. 12, the weight of the pulleys, to a certain extent, neutralize each other.

It will in all cases be found that that quantity by which the weight exceeds the power, is supported by fixed points; and therefore, although it be commonly stated that a small power supports a great weight, yet, in the pulley, as in all other machines, the power supports no more of the weight than is exactly equal to its own amount. It will not be necessary to establish this in each of the examples which have been given; having explained it in one instance, the student will find no difficulty in applying the same reasoning to others. In fig. 15, the fixed pulley sustains a force equal to twice the power, and by it the power giving tension to the first rope sustains a part of the weight equal to itself. The first hook sustains a portion of the weight equal to the tension of the first string, or to the power. The second hook sustains a force equal to twice the power; and the third hook sustains a force equal to four times the power. The three hooks therefore sustain a portion of the weight equal to seven times the power; and the weight itself being eight times the power, it is evident that the part of the weight which remains to be supported by the power, is equal to the power itself.

When a weight is raised by any of the systems of pulleys which have been last described, the proportion between the velocity of the weight and the velocity of the power, so frequently noticed in other machines, will always be observed. In the system of pulleys represented in fig. 15, the weight being eight times the power, the velocity of the power will be eight times that of the weight. If the power be moved through eight feet, that part of the rope between the fixed pulley and the first moveable pulley will be shortened by eight feet. And since the two parts which lie above the first moveable pulley must be equally shortened, each will be diminished by four feet; therefore the first pulley will rise through four feet, while the power moves through eight feet. In the same way it may be shown that while the first pulley moves through four feet, the second moves through two; and while the second moves through two, the third, to which the weight is attached, is raised through one foot. While the power, therefore, is carried through eight feet, the weight is moved through one foot.

By reasoning similar to this it may be shown that the space through which the power is moved in every case is as many times greater than the height through which the weight is raised, as the weight is greater than the power.

From its portable form, cheapness of construction, and the facility with which it may be applied in almost every situation, the pulley is one of the most useful of the simple machines. The mechanical advantage, however, which it appears in theory to possess, is considerably diminished in practice, owing to the stiffness of the cordage and the friction of the wheels and blocks. By this means, it is computed that in most cases so great a proportion as two thirds of the power is lost. The pulley is much used in building, where weights are to be elevated to great heights. But its most extensive application is found in the rigging of ships, where almost every motion is accomplished by its means.

In all the examples of pulleys, we have supposed the parts of the rope sustaining the weight, and each of the moveable pulleys, to be parallel to each other. If they be subject to considerable obliquity, the relative tensions of the different ropes must be estimated according to the principle applied in figure 6.

THE INCLINED PLANE, WEDGE, AND SCREW.

Inclined Plane.—Effect of a Weight on.—Power of.—Roads.—Power oblique to the Plane.—Plane sometimes moves under the Weight.—Wedge.—Sometimes formed of two inclined Planes.—More powerful as its Angle is acute.—Where used.—Limits to the Angle.—Screw.—Hunter's Screw.—Examples.—Micrometer Screw.

inclined plane, and the other expressed by $W E$ upon the resisting plane. These pressures respectively have the same proportion to the entire weight as $W F$ and $W E$ have to $W D$, or as $D E$ and $W E$ have to $W D$, because $D E$ is equal to $W F$. Now the triangle $W E D$ is in all respects similar to the triangle $A B C$, the one differing from the other only in the scale on which it is constructed. Therefore the three lines $A C$, $C B$, and $B A$, are in the same proportion to each other as the lines $W E$, $E D$, and $W D$. Hence $A B$ has to $A C$ the same proportion as the whole weight has to the pressure directed toward B , and $A B$ has to $B C$ the same proportion as the whole weight has to the pressure on the inclined plane.

We have here supposed the weight to be sustained upon the inclined plane, by a hard plane fixed at right angles to it. But the power necessary to sustain the weight will be the same, in whatever way it is applied, provided it act in the direction of the plane. Thus a cord may be attached to the weight, and stretched toward A , or the hands of men may be applied to the weight below it, so as to resist its descent toward B . But in whatever way it be applied, the amount of the power will be determined in the same manner. Suppose the weight to consist of as many pounds as there are inches in $A B$, then the power requisite to sustain it upon the plane will consist of as many pounds as there are inches in $A C$, and the pressure on the plane will amount to as many pounds as there are inches in $B C$.

From what has been stated, it may easily be inferred that the less the elevation of the plane is, the less will be the power requisite to sustain a given weight upon it, and the greater will be the pressure upon it. Suppose the inclined plane $A B$ to turn upon a hinge at B , and to be depressed so that its angle of elevation shall be diminished, it is evident that as this angle decreases, the height of the plane decreases, and its base increases. Thus, when it takes the position $B A'$, the height $A' C'$ is less than the former height $A C$, while the base $B C'$ is greater than the former base $B C$. The power requisite to support the weight upon the plane in the position $B A'$ is represented by $A' C'$, and is as much less than the power requisite to sustain it upon the plane $A B$, as the height $A' C'$ is less than the height $A C$. On the other hand, the pressure upon the plane in the position $B A'$ is as much greater than the pressure upon the plane $B A$, as the base $B C'$ is greater than the base $B C$.

The power of an inclined plane, considered as a machine, is therefore estimated by the proportion which the length bears to the height. This power is always increased by diminishing the elevation of the plane.

Roads which are not level may be regarded as inclined planes, and loads drawn upon them in carriages, considered in reference to the powers which impel them, are subject to all the conditions which have been established for inclined planes. The inclination of the road is estimated by the height corresponding to some proposed length. Thus it is said to rise one foot in fifteen, one foot in twenty, &c., meaning that if fifteen or twenty feet of the road be taken as the length of an inclined plane, such as $A B$, the corresponding height will be one foot. Or the same may be expressed thus: that if fifteen or twenty feet be measured upon the road, the difference of the levels of the two extremities of the distance measured is one foot. According to this method of estimating the inclination of roads, the power requisite to sustain a load upon them (setting aside the effect of friction) is always proportional to that elevation. Thus, if a road rise one foot in twenty, a power of one ton will be sufficient to sustain twenty tons, and so on.

On a horizontal plane, the only resistance which the power has to overcome, is the friction of the load with the plane, and the consideration of this being for the present omitted, a weight once put in motion would continue moving

for ever, without any further action of the power. But if the plane be inclined, the power will be expended in raising the weight through the perpendicular height of the plane. Thus, in a road which rises one foot in ten, the power is expended in raising the weight through one perpendicular foot for every ten feet of the road over which it is moved. As the expenditure of power depends upon the rate at which the weight is raised perpendicularly, it is evident that the greater the inclination of the road is, the slower the motion must be with the same force. If the energy of the power be such as to raise the weight at the rate of one foot per minute, the weight may be moved in each minute through that length of the road which corresponds to a rise of one foot. Thus if two roads rise, one at the rate of a foot in fifteen feet, and the other at the rate of one foot in twenty feet, the same expenditure of power will move the weight through fifteen feet of the one, and twenty feet of the other at the same rate.

From such considerations as these, it will readily appear that it may often be more expedient to carry a road through a circuitous route than to continue it in the most direct course; for, though the measured length of road may be considerably greater in the former case, yet more may be gained in speed with the same expenditure of power, than is lost by the increase of distance. By attending to these circumstances, modern road-makers have greatly facilitated and expedited the intercourse between distant places.

If the power act oblique to the plane, it will have a twofold effect: a part being expended in supporting or drawing the weight, and a part in diminishing or increasing the pressure upon the plane. Let $W P$, fig. 1, be the power. This will be equivalent to two forces, $W F'$, perpendicular to the plane, and $W E'$, in the direction of the plane. In order that the power should sustain the weight, it is necessary that that part $W E'$ of the power which acts in the direction of the plane, should be equal to that part $W E$, fig. 1, of the weight which acts down the plane. The other part $W F$, of the power acting perpendicular to the plane, is immediately opposed to that part $W F$ of the weight which produces pressure. The pressure upon the plane will therefore be diminished by the amount of $W F'$. The amount of the power, which will equilibrate with the weight, may, in this case, be found as follows: Take $W E'$ equal to $W E$, and draw $E' P$ perpendicular to the plane, and meeting the direction of the power. The proportion of the power to the weight will be that of $W P$ to $W D$. And the proportion of the pressure to the weight will be that of the difference between $W F$ and $W F'$ to $W D$. If the amount of the power have a less proportion to the weight than $W P$ has to $W D$, it will not support the body on the plane, but will allow it to descend. And if it had a greater proportion, it will draw the weight up the plane toward A .

It sometimes happens that a weight upon one inclined plane is raised or supported by another weight upon another inclined plane. Thus, if $A B$ and $A B'$, fig. 2, be two inclined planes, forming an angle at A , and $W W'$ be two weights placed upon these planes, and connected by a cord passing over a pulley at A , the one weight will either sustain the other, or one will descend, drawing the other up. To determine the circumstances under which these

Fig. 2.

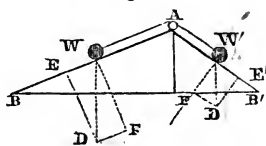

effects will ensue, draw the lines $W D$ and $W' D'$ in the vertical direction, and take upon them as many inches as there are ounces in the weights respectively. $W D$ and $W' D'$ being the lengths thus taken, and therefore representing the weights, the lines $W E$ and $W' E'$ will represent the effects of these weights respectively down the planes. If $W E$ and $W' E'$ be equal, the weights will sustain each other without motion. But if $W E$ be greater than $W' E'$, the weight W will descend, drawing the weight W' up. And if $W' E'$ be greater than $W E$, the weight W' will descend, drawing the weight W up. In every case, the lines $W F$ and $W' F'$ will represent the pressures upon the planes respectively.

It is not necessary for the effect just described, that the inclined planes should, as represented in the figure, form an angle with each other. They may be parallel, or in any other position, the rope being carried over a sufficient number of wheels placed so as to give it the necessary deflection. This method of moving loads is frequently applied in great public works where railroads are used. Loaded wagons descend one inclined plane, while other wagons, either empty or so loaded as to permit the descent of those with which they are connected, are drawn up the other.

In the application of the inclined plane, which we have hitherto noticed, the machine itself is supposed to be fixed in its position, while the weight or load is moved upon it. But it frequently happens that resistances are to be overcome which do not admit to be thus moved. In such cases, instead of moving the load upon the plane, the plane is to be moved under or against the load. Let $D E$, fig. 3, be a heavy beam secured in a vertical position be-

Fig. 3.

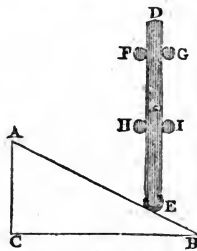

tween guides, $F G$ and $H I$, so that it is free to move upward or downward, but not laterally. Let $A B C$ be an inclined plane, the extremity of which is placed beneath the end of the beam. A force applied to the back of this plane $A C$, in the direction $C B$, will urge the plane under the beam, so as to raise the beam to the position represented in fig. 4. Thus, while the inclined plane is moved through the distance $C B$, the beam is raised through the height $C A$.

Fig. 4.

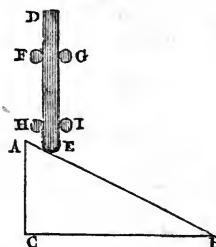

When the inclined plane is applied in this manner, it is called a *wedge*. And if the power applied to the back were a continued pressure, its proportion to the weight would be that of A C to C B. It follows, therefore, that the more acute the angle B is, the more powerful will be the wedge.

In some cases the wedge is formed of two inclined planes, placed base to base, as represented in fig. 5. The theoretical estimation of the power of

Fig. 5.



this machine is not applicable in practice with any degree of accuracy. This is in part owing to the enormous proportion which the friction in most cases bears to the theoretical value of the power, but still more to the nature of the power generally used. The force of a blow is of a nature so wholly different from continued forces, such as the pressure of weights, or the resistance offered by the cohesion of bodies, that they admit of no numerical comparison. Hence we cannot properly state the proportion which the force of a blow bears to the amount of a weight or resistance. The wedge is almost invariably urged by percussion, while the resistances which it has to overcome are as constantly forces of the other kind. Although, however, no exact numerical comparison can be made, yet it may be stated in a general way that the wedge is more and more powerful as its angle is more acute.

In the arts and manufactures, wedges are used where enormous force is to be exerted through a very small space. Thus it is resorted to for splitting masses of timber or stone. Ships are raised in docks by wedges driven under their keels. The wedge is the principal agent in the oil-mill. The seeds from which the oil is to be extracted are introduced into hair bags, and placed between planes of hard wood. Wedges inserted between the bags are driven by allowing heavy beams to fall on them. The pressure thus excited is so intense, that the seeds in the bags are formed into a mass nearly as solid as wood.

Instances have occurred in which the wedge has been used to restore a tottering edifice to its perpendicular position. All cutting and piercing instruments, such as knives, razors, scissors, chisels, &c., nails, pins, needles, awls, &c., are wedges. The angle of the wedge, in these cases, is more or less acute, according to the purpose to which it is to be applied. In determining this, two things are to be considered—the mechanical power, which is increased by diminishing the angle of the wedge, and the strength of the tool, which is always diminished by the same cause. There is, therefore, a practical limit to the increase of the power, and that degree of sharpness only is to be given to the tool which is consistent with the strength requisite for the purpose to which it is to be applied. In tools intended for cutting wood, the angle is generally about 30° . For iron, it is from 50° to 60° ; and for brass, from 80° to 90° . Tools which act by pressure may be made more acute than those which are driven by a blow; and, in general, the softer and more yield-

ing the substance to be divided is, and the less the power required to act upon it, the more acute the wedge may be constructed.

In many cases, the utility of the wedge depends on that which is entirely omitted in its theory, viz., the friction which arises between its surface and the substance which it divides. This is the case when pins, bolts, or nails, are used for binding the parts of structures together; in which case, were it not for the friction, they would recoil from their places, and fail to produce the desired effect. Even when the wedge is used as a mechanical engine, the presence of friction is absolutely indispensable to its practical utility. The power, as has already been stated, generally acts by successive blows, and is therefore subject to constant intermission, and, but for the friction, the wedge would recoil between the intervals of the blows with as much force as it had been driven forward. Thus the object of the labor would be continually frustrated. The friction, in this case, is of the same use as a ratchet-wheel, but is much more necessary, as the power applied to the wedge is more liable to intermission than in the cases where ratchet-wheels are generally used.

When a road directly ascends the side of a hill, it is to be considered as an inclined plane; but it will not lose its mechanical character, if, instead of directly ascending toward the top of the hill, it winds successively round it, and gradually ascends, so as, after several revolutions, to reach the top. In the same manner a path may be conceived to surround a pillar, by which the ascent may be facilitated upon the principle of the inclined plane. Winding stairs constructed in the interior of great columns partake of this character; for although the ascent be produced by successive steps, yet if a floor could be made sufficiently rough to prevent the feet from slipping, the ascent would be accomplished with equal facility. In such a case, the winding path would be equivalent to an inclined plane, bent into such a form as to accommodate it to the peculiar circumstances in which it would be required to be used. It will not be difficult to trace the resemblance between such an adaptation of the inclined plane and the appearances presented by the thread of a screw; and it may hence be easily understood that a screw is nothing more than an inclined plane constructed upon the surface of a cylinder.

This will perhaps be more apparent by the following contrivance: Let A B, fig. 6, be a common round ruler, and let C D E be a piece of white paper cut

Fig. 6.

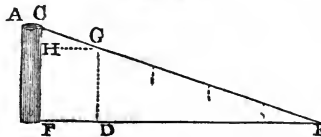

in the form of an inclined plane, whose height C D is equal to the length of the ruler A B, and let the edge C E of the paper be marked with a broad black line: let the edge C D be applied to the ruler A B, and, being attached thereto, let the paper be rolled round the ruler; the ruler will then present the appearance of a screw, fig. 7, the thread of the screw being marked by the black line C E, winding continually round the ruler. Let D F, fig. 6, be equal to the circumference of the ruler, and draw F G parallel to D C, and G H parallel to D E, the part C G F D of the paper will exactly surround the ruler once; the part C G will form one spire of the thread, and may be considered as the length of one inclined plane surrounding the cylinder, C H being the corresponding height, and G H the base. The power of the screw does not, as in the ordinary cases of the inclined plane, act parallel to the plane or

Fig. 7.



thread, but at right angles to the length of the cylinder $A B$, or, what is to the same effect, parallel to the base $H G$; therefore the proportion of the power to the weight will be, according to principles already explained, the same as that of $C H$ to the space through which the power moves parallel to $H G$ in one revolution of the screw. $H C$ is evidently the distance between the successive positions of the thread as it winds round the cylinder; and it appears, from what has been just stated, that the less this distance is, or, in other words, the finer the thread is, the more powerful the machine will be.

In the application of the screw, the weight or resistance is not, as in the inclined plane and wedge, placed upon the surface of the plane or thread. The power is usually transmitted by causing the screw to move in a concave cylinder, on the interior surface of which a spiral cavity is cut, corresponding exactly to the thread of the screw, and in which the thread will move by turning round the screw continually in the same direction. This hollow cylinder is usually called the *nut* or *concave screw*. The screw surrounded by its spiral thread is represented in fig. 8; and a section of the same playing in the nut is represented in fig. 9.

Fig. 8.



Fig. 9.

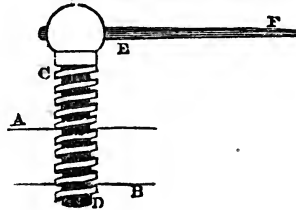

There are several ways in which the effect of the power may be conveyed to the resistance by this apparatus.

First, let us suppose that the nut $A B$ is fixed. If the screw be continually turned on its axis, by a lever $E F$ inserted in one end of it, it will be moved in the direction $C D$, advancing every revolution through a space equal to the distance between two contiguous threads. By turning the lever in an opposite direction, the screw will be moved in the direction $D C$.

If the screw be fixed, so as to be incapable either of moving longitudinally or revolving on its axis, the nut $A B$ may be turned upon the screw by a lever, and will move on the screw toward C or toward D , according to the direction in which the lever is turned.

In the former case, we have supposed the nut to be absolutely immovable, and in the latter case, the screw to be absolutely immovable. It may happen, however, that the nut, though capable of revolving, is incapable of moving

longitudinally; and that the screw, though incapable of revolving, is capable of moving longitudinally. In that case, by turning the nut A B upon the screw by the lever, the screw will be urged in the direction C D or D C, according to the way in which the nut is turned.

The apparatus may, on the contrary, be so arranged, that the nut, though incapable of revolving, is capable of moving longitudinally; and the screw, though capable of revolving, is incapable of moving longitudinally. In this case, by turning the screw in the one direction, or in the other, the nut A B will be urged in the direction C D or D C.

All these various arrangements may be observed in different applications to the machine.

A screw may be cut upon a cylinder by placing the cylinder in a turning-lathe, and giving it a rotatory motion upon its axis. The cutting point is then presented to the cylinder, and moved in the direction of its length, at such a rate as to be carried through the distance between the intended thread, while the cylinder revolves once. The relative motions of the cutting point and the cylinder being preserved, with perfect uniformity, the thread will be cut from one end to the other. The shape of the threads may be either square, as in fig. 8, or triangular, as in fig. 10.

Fig. 10.



The screw is generally used in cases where severe pressure is to be excited through small spaces; it is therefore the agent in most presses. In fig. 11,

Fig. 11.

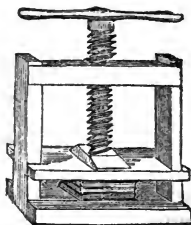

the nut is fixed, and by turning the lever, which passes through the head of the screw, a pressure is excited upon any substance placed upon the plate immediately under the end of the screw. In fig. 12, the screw is incapable of revolving, but is capable of advancing in the direction of its length. On the other hand, the nut is capable of revolving, but does not advance in the direction of the screw. When the nut is turned by means of the screw inserted in it, the screw advances in the direction of its length, and urges the board which is attached to it upward, so as to press any substance placed between it and the fixed board above.

In cases where liquids or juices are to be expressed from solid bodies, the screw is the agent generally employed. It is also used in coining, where the

Fig. 12.

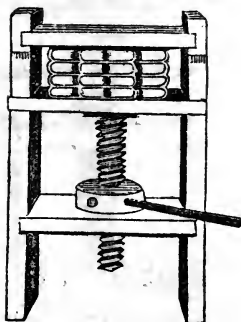

impression of a die is to be made upon a piece of metal, and in the same way in producing the impression of a seal upon wax or other substance adapted to receive it. When soft and light materials, such as cotton, are to be reduced to a convenient bulk for transportation, the screw is used to compress them, and they are thus reduced into hard, dense masses. In printing, formerly, the paper was urged by a severe and sudden pressure upon the types by means of a screw.

As the mechanical power of the screw depends upon the relative magnitude of the circumference through which the power revolves, and the distance between the threads, it is evident, that, to increase the efficacy of the machine, we must either increase the length of the lever by which the power acts, or diminish the magnitude of the thread. Although there is no limit in theory to the increase of the mechanical efficacy by these means, yet practical inconvenience arises which effectually prevents that increase being carried beyond a certain extent. If the lever by which the power acts be increased; the same difficulty arises as was already explained in the wheel and axle: the space through which the power should act would be so unwieldy, that its application would become impracticable. If, on the other hand, the power of the machine be increased by diminishing the size of the thread, the strength of the thread will be so diminished, that a slight resistance will tear it from the cylinder. The cases in which it is necessary to increase the power of the machine being those in which the greatest resistances are to be overcome, the object will evidently be defeated if the means chosen to increase that power deprive the machine of the strength which is necessary to sustain the force to which it is to be submitted.

These inconveniences are removed by a contrivance of Mr. Hunter, which, while it gives to the machine all the requisite strength and compactness, allows it to have an almost unlimited degree of mechanical efficacy.

This contrivance consists in the use of two screws, the threads of which may have any strength and magnitude, but which have a very small difference of breadth. While the working point is urged forward by that which has the greater thread, it is drawn back by that which has the less; so that, during each revolution of the screw, instead of being advanced through a space equal to the magnitude of either of the threads, it moves through a space equal to their difference. The mechanical power of such a machine will be the same as that of a single screw, having a thread whose magnitude is equal to the difference of the magnitudes of the two threads just mentioned.

Thus, without inconveniently increasing the sweep of the power, on the one hand, or, on the other, diminishing the thread until the necessary strength is

lost, the machine will acquire an efficacy limited by nothing but the smallness of the difference between the two threads.

Fig. 13.

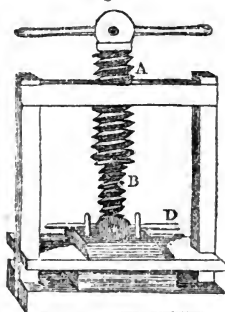

This principle was first applied in the manner represented in fig. 13. A is the greater thread, playing in the fixed nut; B is the lesser thread, cut upon a smaller cylinder, and playing in a concave screw, cut within the greater cylinder. During every revolution of the screw, the cylinder A descends through a space equal to the distance between its threads. At the same time, the smaller cylinder B ascends through a space equal to the distance between the threads cut upon it: the effect is, that the board D descends through a space equal to the difference between the threads upon A and the threads upon B, and the machine has a power proportionate to the smallness of this difference.

Thus, suppose the screw A has twenty threads in an inch, while the screw B has twenty-one: during one revolution, the screw A will descend through a space equal to the twentieth part of an inch. If, during this motion, the screw B did not turn within A, the board D would be advanced through the twentieth of an inch; but because the hollow screw within A turns upon B, the screw B will, relatively to A, be raised in one revolution through a space equal to the twenty-first part of an inch. Thus, while the board D is depressed through the twentieth of an inch by the screw A, it is raised through the twenty-first of an inch by the screw B. It is, therefore, on the whole, depressed through a space equal to the excess of the twentieth of an inch above the twenty-first of an inch—that is, through the four hundred and twentieth of an inch.

The power of this machine will, therefore, be expressed by the number of times the four hundred and twentieth of an inch is contained in the circumference through which the power moves.

In the practical application of this principle at present, the arrangement is somewhat different. The two threads are usually cut on different parts of the same cylinder. If nuts be supposed to be placed upon these, which are capable of moving in the direction of the length, but not of revolving, it is evident that by turning the screw once round, each nut will be advanced through a space equal to the breadth of the respective threads. By this means the two nuts will either approach each other, or mutually recede, according to the direction in which the screw is turned, through a space equal to the difference of the breadth of the threads, and they will exert a force either in compressing or extending any substance placed between them, proportionate to the smallness of that difference.

A toothed wheel is sometimes used instead of a nut, so that the same quality by which the revolution of the screw urges the nut forward is applied to make the wheel revolve. The screw is in this case called an endless screw,

Fig. 14.

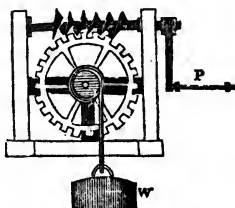

because its action upon the wheel may be continued without limit. This application of the screw is represented in fig. 14. P is the winch to which the power is applied; and its effect at the circumference of the wheel is estimated in the same manner as the effect of the screw upon the nut. This effect is to be considered as a power acting upon the circumference of the wheel; and its proportion to the weight or resistance is to be calculated in the same manner as the proportion of the power to the weight in the wheel and axle.

We have hitherto considered the screw as an engine used to overcome great resistances. It is also eminently useful in several departments of experimental science, for the measurement of very minute motions and spaces, the magnitude of which could scarcely be ascertained by any other means. The very slow motion which may be imparted to the end of a screw, by a very considerable motion in the power, renders it peculiarly well adapted for this purpose. To explain the manner in which it is applied—suppose a screw to be so cut as to have fifty threads in an inch, each revolution of the screw will advance its point through the fiftieth part of an inch. Now, suppose the head of the screw to be a circle, whose diameter is an inch, the circumference of the head will be something more than three inches; this may be easily divided into a hundred equal parts distinctly visible. If a fixed index be presented to this graduated circumference, the hundredth part of a revolution of the screw may be observed, by noting the passage of one division of the head under the index. Since one entire revolution of the head moves the point through the fiftieth of an inch, one division will correspond to the five thousandth of an inch. In order to observe the motion of the point of the screw in this case, a fine wire is attached to it, which is carried across the field of view of a powerful microscope, by which the motion is so magnified as to be distinctly perceptible.

A screw used for such purposes is called a *micrometer screw*. Such an apparatus is usually attached to the limbs of graduated instruments, for the purposes of astronomical and other observation. Without the aid of this apparatus, no observation could be taken with greater accuracy than the amount of the smallest division upon the limb. Thus, if an instrument for measuring angles were divided into small arches of one minute, and an angle were observed which brought the index of the instrument to some point between two divisions, we could only conclude that the observed angle must consist of a certain number of degrees and minutes, together with an additional number of seconds, which would be unknown, inasmuch as there would be no means of ascertaining the fraction of a minute between the index and the adjacent division of the instrument. But if a screw be provided, the point of which moves through a space equal to one division of the instrument, with sixty revolutions of the head, and the head itself be divided into one hundred equal parts, each complete revolution of the screw will correspond to the sixtieth part of a minute, or to one second, and each division on the head of the screw will correspond to the hundredth part of a second. The index being attached to this screw, let the head be turned until the index be moved from its observed

position to the adjacent division of the limb. The number of complete revolutions of the screw necessary to accomplish this will be the number of seconds; and the number of parts of a revolution over the complete number of revolutions will be the hundredth parts of a second necessary to be added to the degrees and minutes primarily observed.

It is not, however, only to angular instruments that the micrometer screw is applicable; any spaces whatever may be measured by it. An instance of its mechanical application may be mentioned in a steel-yard, an instrument for ascertaining the amount of weights by a given weight, sliding on a long graduated arm of a lever. The distance from the fulcrum, at which this weight counterpoises the weight to be ascertained, serves as a measure to the amount of that weight. When the sliding weight happens to be placed between two divisions of the arm, a micrometer screw is used to ascertain the fraction of the division.

Hunter's screw, already described, seems to be well adapted to micrometrical purposes; since the motion of the point may be rendered indefinitely slow, without requiring an exquisitely fine thread, such as, in the single screw, would in this case be necessary.

EBULLITION.

Process of boiling.—Vaporization and Condensation.—Latent Heat of Steam.—Experiments of Black.—Effect of atmospheric Pressure on boiling Point.—Ebullition under increased Pressure—under diminished Pressure.—Relation between the Barometer and boiling Point.—Effect of the Altitude of the Station of the boiling Point.—Elasticity of Steam.—Its Lightness.—Sum of the latent and sensible Heat always the same.—Effect of the Compression of Steam without Loss of Heat.—Steam cannot be liquefied by mere Pressure.—Boiling Points and latent Heat of other Liquids.—Condensation of Vapor.—Principle of the Steam-Engine.—Nature of permanent Gases.—Examples of the Application of the Properties of Steam.

1875

I have the honor to acknowledge the receipt of your letter of the 10th inst. in relation to the above named matter. The same has been referred to the proper authorities for their consideration. I am, Sir, very respectfully,
Your obedient servant,
J. H. [Name]

EBULLITION.

It is known that the continued application of heat to a solid causes it ultimately to pass into the liquid form. We propose, in the present discourse, to examine the effects which would be produced by the continued application of heat to a liquid.

Let a small quantity of water be placed in a glass flask of considerable size, and then closed so as to prevent the escape of any vapor. Let this vessel be now placed over the flame of a spirit lamp, so as to cause the water it contains to boil. For a considerable time the water will be observed to boil, and apparently to diminish in quantity, until at length all the water disappears, and the vessel is apparently empty. If the vessel be now removed from the lamp, and suspended in a cool atmosphere, the whole of the interior of its surface will presently appear to be covered with a dewy moisture; and at length a quantity of water will collect in the bottom of it equal to that which had been in it at the commencement of the process. That no water has at any period of the experiment escaped from it may be easily determined by performing the experiment with the glass flask suspended from the arm of a balance, counterpoised by a sufficient weight suspended from the other arm. The equilibrium will be preserved throughout, and the vessel will be found to have the same weight, when to all appearance it is empty, as when it contains the liquid water. It is evident, therefore, that the water exists in the vessel in every stage of the process, but that it becomes invisible when the process of boiling has continued for a certain length of time; and it may be shown that it will continue to be invisible, provided the flask be exposed to a temperature considerably elevated. Thus, for example, if it be suspended in a vessel of boiling water, the water which it contains will continue to be invisible; but the moment it is withdrawn from the boiling water, and exposed to the cold air, the water will again become visible, as above mentioned, forming a dew on the inner surface, and finally collecting in the bottom as in the commencement of the experiment.

In fact, the liquid has, by the process of boiling, been converted into *vapor* or *steam*, which is a body similar in its leading properties to common air, and, like it, is invisible. It will hereafter appear that it likewise possesses the property of elasticity and other mechanical qualities enjoyed by gases in general.

Again, let an open vessel be filled with water at 60° , and placed in a mercurial bath, which is maintained by a fire or lamp applied to it at the temperature of 230° . Place a thermometer in the water, and it will be observed gradually to rise as the temperature of the water is increased by the heat which it receives from the mercury in which it is immersed. The water will steadily rise in this manner until it attains the temperature of 212° ; but here the thermometer immersed in it will become stationary. At the same time the water contained in the vessel will become agitated, and its surface will present the same appearance as if bubbles of air were rising from the bottom, and issuing at the top. A cloudy vapor will be given off in large quantities from its surface. This process is called *ebullition* or *boiling*. If it be continued for any considerable time, the quantity of water in the vessel will be sensibly diminished; and at length every particle of it will disappear, and the vessel will remain empty. During the whole of this process, the thermometer immersed in the water will remain stationary at 212° .

Now, it will be asked, what has become of the water? It cannot be imagined that it has been annihilated. We shall be able to answer this by adopting means to prevent the escape of any particle of matter from the vessel containing the water into the atmosphere or elsewhere. Let us suppose that the top of the vessel containing the water is closed, with the exception of a neck communicating with a tube, and let that tube be carried into another close vessel removed from the cistern of heated mercury, and plunged in another cistern of cold water. Such an apparatus is represented in fig. 1.

Fig. 1.

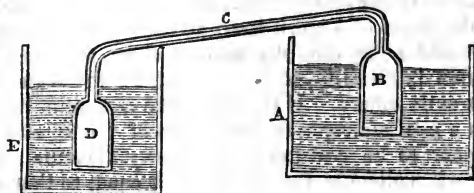

A is a cistern of heated mercury, in which the glass vessel B, containing water, is immersed. From the top of the vessel B proceeds a glass tube C inclining downward, and entering a glass vessel D, which is immersed in a cistern E of cold water. If the process already described be continued until the water by constant ebullition has disappeared, as already mentioned, from the vessel B, it will be found that a quantity of water will be collected in the vessel D; and if this water be weighed, it will be found to have exactly the same weight as the water had which was originally placed in the vessel B. It is, therefore, quite apparent that the water has passed by the process of boiling from one vessel to the other; but, in its passage, it was not perceptible by the sight. The tube C and the upper part of the vessel B had the same appearance exactly as if they had been filled with atmospheric air. That they are not merely filled with atmospheric air in the vessel, may, however, be easily proved. When the process of boiling first commences, it will be found that the tube C is cold, and the inner surface dry. When the process of ebullition

has continued a short time, the tube C will become gradually heated, and the inner surface of it covered with moisture. After a time, however, this moisture disappears, and the tube attains the temperature of 212° . In this state it continues until the whole of the water is discharged from the vessel B to the vessel D.

These effects are easily explained. The water in the vessel B is incapable of receiving any higher temperature than 212° , consistently with its retaining the liquid form. Small portions, therefore, are constantly converted into steam by the heat received from the surrounding mercury, and bubbles of steam are formed on the bottom and sides of the vessel B. These bubbles, being very much lighter, bulk for bulk, than water, rise rapidly through the water, just in the same manner as bubbles of air would, and produce that peculiar agitation at its surface which has been taken as the external indication of boiling. They escape from the surface, and collect in the upper part of the vessel. The steam thus collected, when it first enters the tube C, is cooled below the temperature of 212° by the surface of the tube; and consequently, being incapable of remaining in the state of vapor at any lower temperature than 212° , it is reconverted into water, and forms the dewy moisture which is observed in the commencement of the process on the interior of the tube C. At length, however, the whole of the tube C is heated to the temperature of 212° , and the moisture which was previously collected upon its inner surface is again converted into steam. As the quantity of steam evolved from the water in B increases, it drives before it the steam previously collected in the tube C, and forces it into the vessel B. Here it encounters the inner surface of this vessel, which is kept constantly cold by being surrounded with the cold water in which it is immersed; and the vapor, being thus immediately reduced below the temperature of 212° , is reconverted into water. At first it collects in a dew on the surface of the vessel D; but as this accumulates, it drops into the bottom of the vessel, and forms a more considerable quantity. As the quantity of water is observed to be gradually diminished in the vessel B, the quantity will be found to be gradually increased in the vessel D; and if the operation be suspended at any stage of the process, and the water in the two vessels weighed, it will be found that the weight of the water in D is exactly equal to the weight which the water in B has lost.

The demonstration is, therefore, perfect, that the gradual diminution of the boiling water in the vessel B is produced by the conversion of that water into steam by the heat. In the process first described, when the top of the vessel B was supposed to be open, this steam made its escape into the air, where it was first dispersed, and subsequently cooled in separate particles, and was deposited in minute globules of moisture on the ground and on surrounding objects.

In reviewing this process, we are struck by the fact, that the continued application of heat to the vessel B is incapable of raising the temperature of the water contained in it above 212° . This presents an obvious analogy to the process of liquefaction, and leads to inquiries of a similar nature which are attended with a like result. We must either infer that the water, having arrived at 212° , received no more heat from the mercury; or that such heat, if received, is incapable of affecting the thermometer; or, finally, that the steam which passes off, carries this heat with it. That the water receives heat from the mercury will be proved by the fact, that, if the vessel B be removed from the mercury, other things remaining as before, the temperature of the mercury will rapidly rise, and, if the fire be continued, it will even boil; but so long as the vessel B remains immersed, it prevents the mercury from increasing in temperature. It therefore receives that heat which would otherwise raise the temperature of the quicksilver.

If a thermometer be immersed in the steam which collects in the upper part of the vessel B, it will show the same temperature (of 212°) as the water from which it is raised. The heat, therefore, received from the mercury is clearly not imparted in a sensible form to the steam, which has the same temperature in the form of steam as it had in the form of water. The result of investigations respecting liquefaction would lead us, by analogy, to suspect that the heat imparted by the mercury to the water has become latent in the steam, and is instrumental to the conversion of water into steam, in the same manner as heat was formerly found to be instrumental to the conversion of ice into water. As the fact was in that case detected by mixing ice with water, so we shall, in the present instance, try it by a like test, viz., by mixing steam with water. Let about five and a half ounces of water, at the temperature of 32° , be placed in a vessel A (fig. 2), and let another vessel, B, in which water is kept con-

Fig. 2.

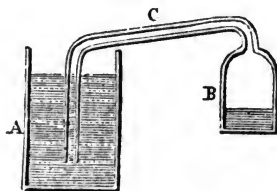

stantly boiling at the temperature of 212° , communicate with A by a pipe C proceeding from the top, so that the steam may be conducted from B, and escape from the mouth of the pipe at some depth below the surface of the water in A. As the steam issues from the pipe, it will be immediately reconverted into water by the cold water which it enters; and, by continuing this process, the water in A will be gradually heated by the steam combined with it and received through the pipe C. If this process be continued until the water in A is raised to the temperature of 212° , it will boil. Let it then be weighed, and it will be found to weigh six and a half ounces; whence we infer that one ounce of water has been received from the vessel B in the form of steam, and has been reconverted into water by the inferior temperature of the water in A. Now, this ounce of water received in the form of steam into the vessel A had, when in that form, the temperature of 212° . It is now converted into the liquid form, and still retains the same temperature of 212° ; but it has caused the five and a half ounces of water with which it has been mixed, to rise from the temperature of 32° to the temperature of 212° , and this *without losing any temperature itself*. It follows, therefore, that, in returning to the liquid state, it has parted with as much heat as is capable of raising five and a half times its own weight of water from 32° to 212° . This heat is combined with the steam, though not sensible to the thermometer; and was, therefore, *latent*. Had it been sensible in the water in B, it would have caused the water to have risen through a number of thermometric degrees, amounting to five and a half times the excess of 212° above 32° : that is, through five and a half times 180° ; for it has caused five and a half times its own weight of water to receive an equal increase of temperature. But five and a half times 180° is 990° , or, to use round numbers (for minute accuracy is not here our object), $1,000^{\circ}$. It follows, therefore, that an ounce of water, in passing from the liquid state at 212° to the state of steam at 212° , receives as much heat as would be sufficient to raise it through 1,000 thermometric degrees, if that heat, instead of becoming latent, had been sensible.

The fact that the steam into which the water is converted contains a considerable quantity of latent heat, and the computation of the exact amount of that quantity will be more clearly understood if we compare the effects produced by mixing an ounce of water at 212° and an ounce of steam at 212° , respectively, with five and a half ounces of water at 32° . We have seen that an ounce of steam at 212° , mixed with five and a half ounces of water at 32° , forms six and a half ounces of water at 212° . Now, if one ounce of water at 212° be mixed with five and a half ounces of water at 32° , the mixture will have a temperature of about 60° . In fact, the 180° , by which the temperature of the ounce of water at 212° exceeds the temperature of the five and a half ounces of water at 32° , are distributed through the mixture in the proportion of the quantity of water, so that each of the five and a half ounces receives the same increment of temperature; and the loss of temperature which the ounce of water at 212° sustains is equally divided among the other five and a half ounces. Now, the mixture, in this case, having a temperature of only 60° , while, in the case where an ounce of steam at 212° was mixed with five and a half ounces of water at 32° , the mixture had the temperature of 212° , it follows that the steam from which the increased heat is all derived contains so much more heat than the ounce of water at the same temperature as would be necessary to raise six and a half ounces of water from the temperature of 60° to the temperature of 212° , or six and a half times as much heat as would be requisite to raise one ounce of water through about 152° of temperature. This quantity of heat will, therefore, be found by multiplying 152° by six and a half, which will give a product of 983° , being nearly equal to the quantity of latent heat determined by the former calculation.

On a subject so important as the latent heat of steam, it may not be uninteresting here to mention some of the means by which Dr. Black, the discoverer of latent heat, computed the quantity absorbed by water in its conversion into vapor.

If a given weight of water be exposed to a regular source of heat, and the time required to raise it from the temperature of 50° to its boiling point be observed, the rate at which it receives heat per minute may be computed. Let the time be then observed which elapses from the commencement of the ebullition to the total disappearance of the water; and if it be assumed that in each minute the same quantity of heat was communicated to the boiling water as was communicated before ebullition commenced, the quantity of heat carried off by the steam may easily be calculated. Some water placed in a tin vessel on a red-hot iron, was observed to rise from 50° to 212° in four minutes, being at the rate of forty and a half degrees per minute. The same water boiled off in twenty minutes. If it received during each of these twenty minutes forty and a half degrees of heat, it must have carried off as much heat in the form of steam as would be sufficient to raise water through twenty times forty and a half degrees, or 810° ; a result corresponding nearly with the quantity of latent heat already determined.

If water submitted to pressure be raised to the temperature of 400° , and the mouth of the vessel which contains it be then suddenly opened, about a fifth of the whole quantity of water will escape in the form of steam, and the temperature of the remainder will immediately fall to 212° . Thus the whole mass of water has suddenly lost 188° of temperature, which is all carried away by one fifth of the mass in the form of steam. Thus, the heat which has become latent in the steam will be determined by multiplying 188° by five, which gives a product of 940° . The steam, therefore, is water combined with at least 940° of heat, the presence of which is not indicated by the thermometer.

The close coincidence of these early observations of Dr. Black with the results of more recent experiments is worthy of notice. The following are the results of observations made by five distinguished philosophers to ascertain the quantity of heat rendered latent by water in the process of vaporization at 212° : Watt, 950° ; Southern, 945° ; Lavoisier, $1,000^{\circ}$; Rumford, $1,004^{\circ}$ 8; Despretz, 955° 8.

The average of all these is about 980° ; so that the round number of $1,000^{\circ}$ may be taken as a close approximation to the latent heat of steam raised from water at the temperature of 212° .

In order to derive all the knowledge from these experiments which they are capable of imparting, it will be necessary to examine very carefully how water comports itself under a variety of circumstances.

If water be boiled in an open vessel, with a thermometer immersed, on different days, it will be observed that the fixed temperature which it assumes in boiling will be subject to a variation within certain small limits. Thus, at one time it will be found to boil at the temperature of 210° ; while, at others, the thermometer immersed in it will rise to 213° ; and, on different occasions, it will fix itself at different points within these limits. It will also be found, if the same experiment be performed at the same time in distant places, that the boiling points will be subject to a like variation. Now, it is natural to inquire what cause produces this variation; and we shall be led to the discovery of the cause, by examining what other physical effects undergo a simultaneous change.

If we observe the height of a barometer at the time of making each experiment, we shall find a very remarkable correspondence between it and the boiling temperature. Invariably, whenever the barometer stands at the same height, the boiling temperature will be the same. Thus, if the barometer stand at thirty inches, the boiling temperature will be 212° . If the barometer fall to twenty-nine and a half inches, the thermometer stands at a small fraction above 211° . If the barometer rise to thirty and a half inches, the boiling temperature rises to nearly 213° . The variation in the boiling temperature is, then, accompanied by a variation in the pressure of the atmosphere indicated by the barometer; and it is constantly found that the boiling point will remain unchanged so long as the atmospheric pressure remains unchanged, and that every increase in the one causes a corresponding increase in the other.

From these facts it must be inferred that the pressure excited on the surface of the water has a tendency to resist its ebullition, and to make it necessary, before it can boil, that it should receive a higher temperature; and, on the contrary, that every diminution of pressure on the surface of the water will give an increased facility to the process of ebullition, or will cause that process to take place at a lower temperature. As these facts are of the utmost importance in the theory of heat, it may be useful to verify them by direct experiment.

If the variable pressure excited on the surface of the water by the atmosphere be the cause of the change in the boiling temperature, it must happen that any change of pressure produced by artificial means on the surface of the water must likewise change the boiling point, according to the same law. Thus, if a pressure considerably greater than the atmospheric pressure be excited on a liquid, the boiling point may be expected to rise considerably above 212° ; and, on the other hand, if the surface of the water be relieved from the pressure of the atmosphere, and be submitted to a considerably diminished pressure, the water would boil below 212° .

Let B, fig. 3, be a strong spherical vessel of brass, supported on a stand S, under which is placed a large spirit lamp L, or other means of heating it. In

Fig. 3.

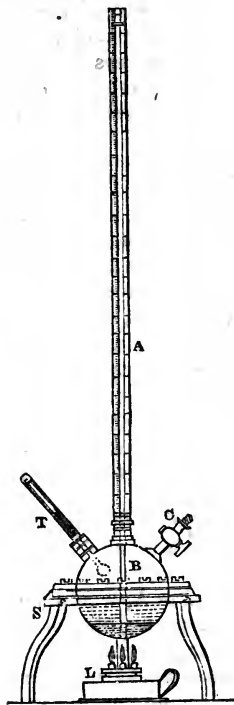

the top of this vessel are three apertures, in two of which are screwed a thermometer T, the bulb of which enters the hollow brass sphere, and a stopcock C, which may be closed or opened at pleasure, to confine the steam, or allow it to escape. In the third aperture, at the top, is screwed a long barometer tube, open at both ends. The lower end of this tube extends nearly to the bottom of the spherical vessel B. In the bottom of this vessel is placed a quantity of mercury, the surface of which rises to some height above the lower end of the tube A. Over the mercury is poured a quantity of water, so as to half fill the vessel B. Matters being thus arranged, the screws are made tight so as to confine the water, and the lamp is allowed to act on the vessel; the temperature of the water is raised, and steam is produced, which, being confined within the vessel, exerts its pressure on the surface of the water, and resists its ebullition. The pressure of the steam acting on the surface of the water, is communicated to the surface of the mercury, and it forces a portion of the mercury into the tube A, which presently rises above the point where the tube is screwed into the top of the vessel B. As the action of the lamp continues, the thermometer T exhibits a gradually increasing temperature; while the column of mercury in A shows the force with which the steam presses on the surface of the water in B, this column being balanced by the pressure of the steam. Thus, the temperature and pressure of the steam at the same moment may always be observed by inspecting the thermometer T and the tube A. When the column in the tube A has risen to the height of 30 inches above the level of the mercury in the vessel B, then the pressure of the steam will be equivalent to double the pressure of the atmosphere, because

the tube A being open at the top, the atmosphere presses on the surface of the mercury in it. The thermometer T will be observed gradually to rise until it attains the temperature of 212° ; but it will not stop there, as it would do if immersed in water boiled in an open vessel. It will, on the other hand, continue to rise; and when the column of mercury in A has attained the height of 30 inches, the thermometer T will have risen to 250° , being 18° above the ordinary boiling point.

During the whole of this process, the surface of the water being submitted to a constantly increasing pressure, its ebullition is prevented, and it continues to receive heat without boiling. That it is the increased pressure which resists its ebullition, and causes it to receive a temperature above 212° , may be easily shown. Let the stopcock C be opened: immediately the steam in B, having a pressure considerably greater than that of the atmosphere, will rush out, and will continue to issue from C, until its pressure is balanced by the atmosphere. At the same time the column of mercury in A will be observed rapidly to fall, and to sink below the orifice by which it is inserted in the vessel B. The thermometer T also falls until it attains the temperature of 212° . At that point, however, it remains stationary; and the water will now be distinctly heard to be in a state of rapid ebullition. If the stopcock C be once more closed, the thermometer will begin to rise, and the column of mercury ascending in A will be again visible.

If, instead of a stopcock being at C, the aperture were made to communicate with a valve, like the safety-valve of a steam-engine, loaded with a certain weight, say at the rate of fifteen pounds on the square inch, then the thermometer T, and the mercury in the tube A, would not rise indefinitely as before. The thermometer would continue to rise till it attained the temperature of 250° , and the mercury in the tube A would rise to the height of 30 inches. At this limit the resistance of the valve would be balanced by the pressure of the steam; and as fast as the water would have a tendency to produce steam of a higher pressure, the valve would be raised, and the steam suffered to escape; the thermometer T and the column of mercury in A remaining stationary during this process. If the valve were loaded more heavily, the phenomena would be the same, only that the mercury in T and A would become stationary at certain heights. But, on the other hand, if the valve were loaded at a less pressure than fifteen pounds on the square inch, then the mercury in the two tubes would become stationary at lower points.

These experiments show that every increase of pressure above the ordinary pressure of the atmosphere causes an increase in the temperature at which water boils. We shall now inquire whether a diminution of pressure will produce a corresponding effect on the boiling point.

This may be easily accomplished by the aid of an air-pump. Let water at the temperature of 200° be placed in a glass vessel under the receiver of an air-pump, and let the air be gradually withdrawn. After a few strokes of the pump the water will boil; and if the mercurial gauge of the pump be observed, it will be found that its altitude will be about twenty-three and a half inches. Thus the pressure to which the water is submitted has been reduced from the ordinary pressure of the atmosphere expressed by the column of thirty inches of mercury to a diminished pressure expressed by twenty-three and a half inches; and we find that the temperature at which the water boils has been lowered from 212° to 200° . Let the same experiment be repeated with water at the temperature of 180° , and it will be found that a further rarefaction of the air is necessary, but the water will at length boil. If the gauge of the pump be now observed, it will be found to stand at about fifteen inches, showing that at the temperature of 180° water will boil under half the ordinary

pressure of the atmosphere. These experiments may be varied and repeated; and it will be always found, that as the pressure is diminished or increased, the temperature at which the water will boil will be also diminished or increased.

The same effects may be exhibited in a striking manner without an air-pump, by producing a vacuum by the condensation of steam. Let a small quantity of water be placed in a thin glass flask, and let it be boiled by holding it over a spirit lamp. When the steam is observed to issue abundantly from the mouth of the flask, let it be quickly corked and removed from the lamp. The process of boiling will then cease, and the water will become quiescent; but if the flask be plunged in a vessel of cold water, the water it contains will again pass into a state of violent ebullition, thus exhibiting the singular fact of water being boiled by cooling it. This effect is produced by the cold medium in which the flask is immersed causing the steam above the surface of the water in it to be condensed, and therefore relieving the water from its pressure. The water, under these circumstances, boils at a lower temperature than when submitted to the pressure of the uncondensed vapor.

There is no limit to the temperature to which water may be raised, if it be submitted to a sufficient pressure to resist its tendency to take the vaporous form. If a strong metallic vessel be nearly filled with water, so as to prevent the liquid from escaping by any force which it can exert, the water thus enclosed may be heated to any temperature whatever without boiling; in fact, it may be made red hot, and the temperature to which it may be raised will have no limit, except the strength of the vessel containing it, or the point at which the metal of which it is formed may begin to soften or to be fused.

The following table will show the temperature at which water will boil under different pressures of the atmosphere corresponding to the altitudes of the barometer between 26 and 31 inches:—

Barometer.	Boiling point.
26 inches.....	204°·91
26·5.....	205°·79
27.....	206°·67
27·5.....	207°·55
28.....	208°·43
28·5.....	209°·31
29.....	210°·19
29·5.....	211°·07
30.....	212°
30·5.....	212°·88
31.....	213°·76

From this table it appears that for every tenth of an inch which the barometric column varies between these limits, the boiling temperature changes by the fraction of a degree expressed by the decimal $\cdot 176$, or nearly to the vulgar fraction $\frac{1}{6}$.

It is well known, that as we ascend in the atmosphere, the pressure is diminished in consequence of the quantity of air left below it, and consequently the barometer falls as it is elevated. It follows, therefore, that in stations at different heights in the atmosphere, water will boil at different temperatures; and the medium temperature of ebullition at any given place must, therefore, depend on the elevation of that place above the surface of the sea. Hence the temperature of boiling water, other things being the same, becomes an indication of the height of the station at which the water is boiled, or in other words, becomes an indication of the atmospheric pressure; and thus the thermometer serves in some degree the purpose of a barometer.

We have seen that the vapor into which water is converted by heat possesses the leading qualities of common atmospheric air; and if not submitted to a minute examination, might be mistaken for highly heated air. It is perfectly transparent and invisible; for, in the first experiment described in this discourse, when the water was boiled in the flask until the whole of the liquid had been converted into steam, the flask had the same appearance as if it were filled with air. It might be objected to this statement, that the steam which issues from the spout of a boiling kettle, or which proceeds from the surface of water boiling in an open vessel, is visible, since it presents the appearance of a cloudy smoke. This appearance, however, is produced, not by steam, but by very minute particles of water arising from the condensation of steam in passing through the cold air. These minute particles, floating in the air, become in some degree opaque, and are visible like the particles of smoke. Such cloudy substances, therefore, are not true vapor or steam.

But the most important property which steam enjoys in common with atmospheric air and other gases, and on which, like them, all its mechanical properties depend, is its elasticity or pressure. If a quantity of pure steam be confined in a close vessel, it will, like air, exert on every part of the interior surface of that vessel a certain determinate pressure, directed outward, and having a tendency to burst the vessel. A bladder might thus be inflated with steam in the same manner as with atmospheric air; and, provided the temperature of the bladder be sustained at that point necessary to prevent the steam from returning to the liquid form, its inflation would continue.

By virtue of this property of elasticity, steam or air is expansible, and, when freed from the limits which confine it, will dilate into any space to which it may have access. Suppose a piston placed in a cylinder, in which it moves steam-tight, and between the piston and the bottom of the cylinder let any quantity of steam be contained; if the piston be drawn upward, so as to produce a larger space below it in the cylinder, the steam will expand, and fill the increased space as effectually as it filled the more limited dimensions in which it was first contained. As it expands, however, its elastic pressure diminishes in exactly the same manner, and in the same proportion, as that of atmospheric air. When the space it occupied is doubled, its temperature being preserved, its elastic pressure is halved; and, in like manner, in whatever proportion the space it fills be increased, its elastic pressure will be in the same proportion diminished.

It is found that the steam which is raised from water boiling under any given pressure has an elasticity always equal to the pressure under which the water boils. Thus, when water is boiled under the ordinary atmospheric pressure, when the barometer stands at thirty inches, the steam which is dismissed at the temperature of 212° has an elastic pressure equal to that of the atmosphere. If water be boiled under a diminished pressure, and therefore at a lower temperature, the steam which is produced from it will have a pressure which is diminished in an equal degree. Thus, water boiled under pressure corresponding to fifteen inches of mercury, and at a temperature of 180° , will produce steam, the elasticity of which will be equivalent to a column of fifteen inches of mercury.

Numerous experiments have been made, and investigations instituted, with a view to determine some fixed relation between the temperature at which water boils, and the elasticity of the steam which it produces; but hitherto without success. That some fixed relation does exist, there can be no doubt; because at the same temperature steam of the same elasticity is invariably produced. Tables are constructed expressing the elasticity or pressure corresponding to different temperatures, and empirical formulæ or rules have been

attempted to be formed from the results of these tables, by which the elasticity may in general be deduced from the temperature, and *vice versa*.

Another remarkable property which steam enjoys, in common with the air and the gases, is its extreme lightness compared with the ordinary weight of bodies in the liquid and solid forms; when water is boiled under the medium pressure of the atmosphere, the barometer standing at thirty inches, the steam which is produced from it is, bulk for bulk, nearly seventeen hundred times lighter than the water from which it is raised. Thus, a cubic inch of water, when converted into steam at 212° , will produce about seventeen hundred cubic inches of steam. At a first view it might be supposed that this enormous increase of bulk might proceed from the circumstance of some other body being combined with the water in forming the steam; but that this is not the case, or, at least, that no ponderable body is so combined with it, may be determined by weighing the steam and the water respectively. These weights will always be found, as already stated, to be equal. This expansion which water undergoes in its transition from the liquid to the vaporous state is subject to great variation, as we shall presently explain, according to the temperature and pressure at which it is raised.

In the experiment already described, by which the latent heat of steam was determined, the water was supposed to be boiled under the ordinary pressure of the atmosphere. Having seen, however, that water may boil at different temperatures under different pressures, the inquiry presents itself, whether the heat absorbed in vaporization at different temperatures and under different pressures, is subject to any variation? Experiments of the same nature as those already described, instituted upon water in a state of ebullition at different temperatures as well below as above 212° , have led to the discovery of a very remarkable fact in the theory of vapor. It has been found that the heat absorbed by vaporization is always less, the higher the temperature at which the ebullition takes place; and less, by the same amount as the temperature of ebullition is increased. Thus, if water boil at 312° , the heat absorbed in ebullition will be less by 100° than if it boiled at 212° ; and again, if water be boiled under a diminished pressure, at 112° , the heat absorbed in vaporization will be 100° more than the heat absorbed by water boiled at 212° . It follows, therefore, that the actual consumption of heat in the process of vaporization must be the same, whatever be the temperature at which the vaporization takes place; for whatever heat is saved in the sensible form is consumed in the latent form, and *vice versa*.

Let us suppose a given weight of water at the temperature of 32° to be exposed to any regular source by which heat may be supplied to it. If it be under the ordinary atmospheric pressure, the first 180° of heat which it receives will raise it to the boiling point, and the next $1,000^{\circ}$ will convert it into steam. Thus, in addition to the heat which it contains at 32° , the steam at 212° contains $1,180^{\circ}$ of heat. But if the same water be submitted to a pressure equal to half the atmospheric pressure, then the first 148° of heat which it receives will cause it to boil, and the next $1,032^{\circ}$ will convert it into vapor. Thus, steam at the temperature of 180° contains a quantity of heat more than the same quantity of water at 32° , by $1,032^{\circ}$ added to 148° , which gives a sum of $1,180^{\circ}$. Steam, therefore, raised under the ordinary pressure of the atmosphere at 212° , and steam raised under half that pressure at 180° , contain the same quantity of heat, with this difference only, that the one has more latent heat, and less sensible heat, than the other.

From this fact, that the sum of the latent and sensible heats of the vapor of water is constant, it follows that the same quantity of heat is necessary to convert a given weight of water into steam, at whatever temperature or under

whatever pressure the water may be boiled. It follows also that, in the steam-engine, equal weights of high-pressure and low-pressure steam are produced by the same consumption of fuel; and that, in general, the consumption of fuel is proportional to the quantity of water vaporized, whatever the pressure of the steam may be.

The quantity of heat consumed thus depending on the weight of water evaporated, it is obviously a point of considerable practical importance to determine the specific gravities or densities of steam raised under different pressures, and at different temperatures; yet this is a point on which even philosophical authorities, in general entitled to respect, appear to have fallen into error. It has been stated that the specific gravity or density of steam is always proportional to its pressure.* This, however, is not correct. The true law for the variation of the density or specific gravity of steam is the same as that of air: it is proportional to the pressure or elasticity, *provided the temperatures are the same*. If, then, we have steam raised from water under two different pressures, and at two different temperatures, let the temperatures be equalized by applying heat to the steam of the lesser pressure out of contact with water, its pressure being meanwhile preserved. When the temperatures are thus rendered equal, then their densities or specific gravities will be in the same proportion as their pressures.

If the space below the piston P, in the cylinder A B, fig. 4, be completely

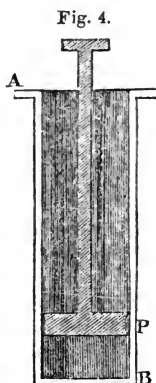

filled with water, and a sufficient force be exerted on the piston to prevent it from rising in the cylinder, the water under it may be heated to any required temperature; because, no space being allowed for the formation of steam, no heat can become latent, and therefore all the heat communicated to the water will be effective in raising its temperature. If the temperature of the water under these circumstances were raised until it attained the limit of $1,212^{\circ}$, it would have all the heat necessary to give it the vaporous form, no part of that heat being in this case latent. In fact, the water would, under such circumstances, be converted into vapor, in which the whole of the heat would be sensible, and which would have no latent heat except such as the water possessed in the liquid state. If the piston, under these circumstances, be raised, the water, or rather steam, below it, will expand; and as it expands, its temperature will fall, a portion of the sensible heat becoming latent. If the piston were raised until the space below it were increased seventeen hundred times, the steam would fall to the temperature of 212° , and $1,000^{\circ}$ of heat would be-

* Thomson on Heat and Electricity, p. 221.

come latent. In fact, the steam would then be identical in its constitution and properties with steam raised from water at the temperature of 212° , and under the ordinary atmospheric pressure. If the piston be raised or lowered under these circumstances, the steam would take all possible temperatures and pressures, and would, in each case, be identical with the steam raised from water under a corresponding pressure and temperature.

The sum of the latent and sensible heats of steam being always the same, it follows that, if we know the latent heat of steam at any one temperature, the latent heats at all other temperatures is a subject of easy calculation. Thus, if the sum of the latent and sensible heats be $1,212^{\circ}$, the latent heat of steam at 500° of temperature must necessarily be 712° , and steam at the temperature of $1,000^{\circ}$ will have only 212° of latent heat.

It follows also that, in order to maintain water in a state of vapor, the sum of its latent and sensible heats cannot be less than $1,212^{\circ}$; and if it be reduced below this, by being caused to impart heat to any other object, then a portion of the vapor must return to the liquid state, giving its latent heat to the vapor which remains, so as to raise the sum of the latent and sensible heats of that vapor to $1,212^{\circ}$. When so much steam becomes liquid as is capable of accomplishing this, then the remainder of the vapor will continue in the aeriform state. If steam receives no heat except that which is imparted to the water during the process of vaporization, the sum of its latent and sensible heats cannot be greater than $1,212^{\circ}$, and therefore such steam cannot lose any heat without undergoing partially the process of condensation; but if steam, after the process of vaporization, has received an increase of temperature by heat supplied from some external source, then the sum of its latent and sensible heats will be greater than $1,212^{\circ}$ by the heat so received, and the steam may lose that excess of heat above $1,212^{\circ}$ without undergoing any condensation.

In considering the properties of steam at present, we shall, however, regard it as having received no heat except that which it receives in the process of vaporization, unless the contrary be distinctly expressed.

It is well known that air and the gases generally admit of compression and rarefaction without any practical limit, and that their elasticity is susceptible of increase and diminution, as the space they fill is contracted or enlarged. Let a cylinder, in which a piston moves air-tight, have the space below the piston filled with atmospheric air in its ordinary state. By the application of adequate mechanical force, the piston may be pressed toward the bottom of the cylinder, so that the air beneath it shall be forced into a more confined space. The effect of this compression will be twofold—an increase of temperature and an increase of elasticity. If the piston, on the other hand, be raised so as to allow the air to expand into a more enlarged space, the contrary effects will ensue—the temperature of the air will fall, and its elasticity will be diminished. Whether air thus enclosed be compressed into a more limited space, or allowed to expand into a more enlarged space, it never passes from the aeriform state, nor loses its property of elasticity. No known degree of compression has caused it to become a liquid, nor has any degree of expansion caused it to lose its elastic property.

Let us now suppose the space below the piston, instead of air, to be filled with steam raised from water at the temperature of 212° . If the piston be raised, this steam will expand, its temperature will fall, and its elastic force will diminish in the same manner as already described for common air, and, as with common air, there is no known limit to the extent of this expansion.

If, however, the piston be pressed toward the bottom of the cylinder, it has been generally stated that steam will not comport itself like common air under

the same circumstances ; that it will not retain the vaporous form on being compressed, nor increase its elasticity ; but that, on the contrary, as the piston is depressed, it will be partially restored to the liquid state, and that the portion which remains in the vaporous form will retain the same density and elasticity as it had before the piston was moved. In fact, if the piston be depressed so as to reduce the space occupied by the steam to one half its original dimensions, it has been assumed that in that case one half the steam under the piston would be restored to the liquid form, and would become water of the temperature of 212° , while the remaining half would still retain the vaporous form, and have the same temperature and density as before.*

From this statement, however universally admitted, I must most distinctly dissent, unless it be assumed, at the same time, that a large quantity of heat has been abstracted from that portion of the steam which is reduced to the liquid form. If this do not happen, and the same quantity of heat remain in the vapor under the piston, no change to the liquid form can, in my opinion, take place. The steam originally contained in the cylinder below the piston has that quantity of latent and sensible heat which is *necessary* and *sufficient* to maintain it in the vaporous form *in all degrees of density*. If the steam be compressed by the piston, we cannot suppose a portion of it to be condensed into a liquid, without at the same time supposing that portion to part with about $1,000^{\circ}$ of latent heat ; but this supposition cannot be admitted, unless we suppose the heat so dismissed to pass off to some external object, the contrary of which is the supposition upon which I have here argued.

I consider that the effects of the compression of steam thus enclosed would be the same as already described with respect to air. The temperature and pressure will be increased, but no portion of it will be condensed into a liquid. In every state of density to which it will be reduced by compression it will take that temperature and pressure which steam of the *same density* raised immediately from water would have. If the piston be depressed so as to reduce the steam to one half its original bulk, then, its density being doubled, it will acquire that temperature at which steam of double the degree of density would be raised from water. The steam will be in all respects, both with regard to its latent and sensible heat, its density and its elasticity, the same as steam raised from water boiled at the increased temperature. Similar observations may be applied to any degree of compression whatever ; and it will follow, not only that no part of the steam will be restored to the liquid form by reducing its bulk, but that no degree of compression whatever will be capable of reducing any part of it to the liquid state. If the piston could be moved toward the bottom, so as to reduce the dimensions of the steam to those which it had when it existed in the liquid state, which would be accomplished by advancing it within a distance of the bottom of the cylinder equal to about the seventeen hundredth part of its original distance, it would continue to be steam, but would have a prodigiously increased elastic force, and a temperature of $1,212^{\circ}$. The steam would in such case be reduced to the state explained in page 308, and would be identical with water raised in a close vessel to the temperature of $1,212^{\circ}$. It is obvious that the practical exhibition of such effects as here described would be obstructed by the difficulty of preventing the escape of the sensible heat developed in the compression of the steam.

The true cause of the conversion of any part of a vapor to the liquid form, I consider to be *the diminution of that sum of sensible and latent heat which is essential to the existence of vapor*. Such a loss of heat would equally cause the vapor to return to the liquid state, whether compressed into a less bulk or ex-

* See Biot, *Traité de Physique*, tom. i., p. 266, and physical and chemical writers generally.

panded into a greater one. If the piston had been previously raised, and a small quantity of heat at the same time abstracted from the vapor, a portion of the vapor would immediately be condensed, and a small portion would be condensed by the same loss of heat, in whatever state of compression or rarefaction the steam may exist. This condensation is therefore altogether independent of any effects produced on the density of the steam by any mechanical compression.*

The pressure on the surface of water, though the principal cause which affects the boiling point, is not the only one. It has been already stated that the material of which the vessel is composed, in which the process of boiling takes place, has also an effect upon the boiling temperature. It is found that in a vessel of glass, water boils at a lower temperature than in a vessel of metal. Foreign matter also held in solution by the water produces a change in its boiling point; but this should rather be considered as a distinct liquid.

If heat be applied to other liquids, results will be obtained showing that the phenomena already explained with respect to water, are only instances of a more numerous class, applicable to all liquids whatever. The application of heat to any liquid causes its temperature, in the first instance, to rise; and this increase of temperature continues until the liquid attains a state similar to that of boiling water, when a thermometer or pyrometer, immersed in it, would become stationary. The continued application of heat now no longer causes the liquid to rise in temperature, but produces vapor rapidly, so that the liquid boils away in the same manner as already described with respect to water, and all the effects before explained take place, differing only in the temperature at which the ebullition commences, and in the rate at which the vapor is produced. Different liquids attain the stationary temperature of ebullition at different points; and hence the boiling point becomes a specific character to distinguish material substances. They likewise, in passing into the vaporous form, render different quantities of heat latent.

Let a thermometer, consisting of two metallic bars, be fixed in a vessel so as to extend across it in a horizontal position, and so that the extremity, bearing the graduated scale, shall pass through the side and project outside the vessel. Let melted lead be now poured into this vessel, so as to cover the pyrometric bars, and let the whole be placed on a furnace. The divided scale, during the continued application of the fire, will constantly show an increasing temperature until the lead boils. The expansion of the bars will then cease, and the pyrometer will become fixed in its indication, and will continue fixed until the whole of the lead is evaporated.

Again, let a common thermometer be immersed in phosphorus at the temperature of 300° , and, being placed in a vessel, let it be exposed to the action of heat. It will continue to rise until it attains the temperature of 554° , where it will become stationary, and the phosphorus will boil. The thermometer will become stationary until the whole of the phosphorus is evaporated.

The correspondence of these results with those obtained in the experiments instituted upon water is obvious. The analogy might be still further confirmed by using a close vessel, like that represented in fig. 1, and carrying over the vapor of the lead, or the phosphorus, into a vessel exposed to cold, where it might be re-collected in the liquid form. It is clear that, in all these instances, during the process of ebullition, heat has become latent, because heat continues to be supplied to the vaporizing body, although the vapor produced by the supply of such heat is found to have no greater temperature than that of the liquid from which it is produced. The same result would be obtained by simi-

* I have been the more minute in these details, because my opinions differ from those commonly received respecting the effects of compression upon steam.

lar experiments made on other substances; and we may, therefore, generalize the facts established by the experiments already described upon water, and state that all bodies, when in the liquid form, are capable, by increasing their temperatures, of being converted into vapor; and that in this conversion a large quantity of heat must be supplied, which becomes latent in the vapor, because, notwithstanding the increased supply of heat given to it, it exhibits no corresponding increase of temperature.

There is no liquid upon which the effects of heat have been so minutely examined as water. The latent heats of a few other liquids have been accurately determined; but much still remains to be done in this department of physics. Count Rumford examined the latent heats of several vapors, by causing them to be condensed in a refrigeratory, so that they imparted their latent heat to water. He then determined the weight of the liquid which had been condensed, and, by comparing with it the heat imparted to the water in the refrigeratory, he obtained the latent heat. Dr. Ure and M. Despretz also made experiments on some liquids, the results of which were as follows:—

		Latent Heat.	Latent Heat referred to Water.
Steam.....	Despretz	956°	
Alcohol vapor (specific gravity 0.793).....	Despretz	597.4	373°·86
Sulphuric ether (specific gravity 0.715).....	Despretz	314.1	163.44
Oil of turpentine	Despretz	299.16	138.24
Ammonia (specific gravity .0978).....	Ure	837.28	862
Nitric acid (specific gravity 1.494).....	Ure	531.99	335
Naphtha.....	Ure	177.87	73.77

The boiling points of all liquids are affected by pressure in the same manner as the boiling point of water, every increase of pressure causing it to fall. In comparing the boiling points of different liquids one with the other, it is, therefore, necessary to take them all under the same pressure; and the pressure usually adopted for this purpose is the medium pressure of the atmosphere, or thirty inches of mercury.

The comparison of the melting and boiling points of bodies does not present any general feature which could serve as a basis for any obvious inference, connecting the phenomena of fusion and ebullition with their other properties. Generally, but not invariably, the higher on the scale of temperature the melting point is, the higher will be the boiling point; but to this there are many exceptions. Mercury freezes at 39° below 0°, and boils at a temperature of about 660°; while, on the other hand, phosphorus melts at 140° above the melting temperature of mercury, and boils at about 110° below the boiling temperature of that metal.

Since, by continually imparting heat to it, a body in the liquid state at length passes into the form of vapor or air, analogy would lead us to expect that, by continually withdrawing heat, a body in the aeriform state would at length return to the liquid state. In the case of vapor raised from liquids by heat, this is found to be universally true. In the experiment illustrated by figure 1, the steam of water, having passed from the heated vessel to one maintained at a lower temperature, was caused to impart its heat to the surrounding medium, and immediately returned to the liquid state. The same result would be obtained under the same circumstances in any liquid body vaporized. The vapor, being exposed to cold, is deprived of a part of that heat which is necessary to sustain it in the aeriform state, and a portion of it is accordingly restored to the liquid form, and this continues until, by the constant abstraction of heat, the whole of the vapor becomes liquid. As a liquid, in passing to the vapor-

ous form, undergoes an immense expansion or increase of bulk, so a vapor, in returning to the liquid form, undergoes a corresponding and equal diminution of bulk. A cubic inch of water transformed into steam at 212° , enlarges in magnitude to seven hundred cubic inches, as already observed. The same steam, reconverted into water by abstracting from it the heat consumed in its vaporization, will be restored to its former bulk, and will form one cubic inch of water at 212° . Vapors raised from other bodies would undergo a similar change, differing only in the degree of diminution of bulk which they would suffer respectively. The diminished space into which the particles of a vapor are gradually condensed when it passes into the liquid state has caused this process to be called *condensation*.*

No liquid has been submitted to so minute an examination, with respect to the effects produced upon it by heat, as water; and, with respect to other liquids, we are compelled, in the absence of experimental proof, to reason from analogy. The principle that the sum of the latent and sensible heats of vapor is the same for all temperatures, may be extended, with a high degree of probability, to the vapors of all liquids whatever; so that we may assume this sum to be constant for each liquid, though differing in one liquid compared with another. To maintain the vapor of any liquid in the aeriform state, it is therefore necessary that it should contain at least a certain quantity of heat, whatever be its temperature; and any diminution in this quantity cannot fail to produce the condensation of a corresponding portion of the vapor. If the vapor of a liquid, therefore, has received no heat after having passed from the liquid to the vaporous form, it cannot lose any portion of the heat it contains without a partial condensation; but it is important to observe, that a vapor, whether of water or any other liquid, may, after having attained the state of vapor, receive an additional supply of heat to any extent, and may thus have its temperature raised to any point whatever. Independently of the heat which it received in the process of vaporization, all the heat which it has thus received in the state of vapor it may lose, and yet remain in that state. Under such circumstances, therefore, it must not be inferred that a reduction of temperature in vapor necessarily causes condensation. Condensation cannot commence until the vapor loses all that heat which it received after taking the form of vapor; but when it has lost so much, then any further abstraction of heat must be attended by condensation.

By the great change of volume which a vapor undergoes in condensation, it becomes an efficient means of producing a vacuum, without the exertion of mechanical force. Let a glass tube be provided, having at one extremity a large bulb, the other extremity being open. Let a small quantity of liquid be introduced into the bulb through the tube, and let a spirit lamp be placed under the bulb, so as to cause the liquid to boil. The vapor of the liquid will first mix with the air in the bulb and tube; but, as its quantity increases, its elasticity will cause it to issue through the tube, which it will at length raise to its own temperature, so as to enable it to pass from the mouth of the tube in the vaporous form, without being previously condensed. The stream of vapor proceeding up the tube will, after a time, carry off with it the atmospheric air previously contained in the bulb and tube; and at length the space below the mouth of the tube will be completely filled with pure vapor. Let the tube be now inverted, and its open end plunged in a vessel of water or other liquid, the bulb being presented upward. The space within the tube and bulb containing

* In general, whenever the dimensions of a body are diminished, without any diminution of its quantity of matter, it is said to be condensed, and the process may without impropriety be called *condensation*; but this more general application of the term cannot cause any confusion, since its meaning is always easily understood from the context.

pure vapor will be thus cut off from all communication with the air. The inferior temperature of the surrounding air, taking heat constantly from the bulb and tube, will deprive the vapor contained in them of the quantity of heat necessary to sustain it in the elastic form, and it will be condensed. The great diminution of bulk which it will suffer will cause a partial vacuum to be produced in the bulb and tube, and the pressure of the atmosphere, acting on the surface of the water in the vessel in which the tube is immersed, will force the water up the tube, and and it will completely fill the bulb.

That form of the steam-engine called the *low-pressure engine*, derives its principal mechanical efficacy from this property, by which steam is instrumental in the formation of a vacuum. The moving power in that machine is rendered operative by a piston placed in a cylinder, in which it moves steam-tight. The atmospheric air and other gases are expelled from the cylinder and tubes which communicate between it and the boiler by steam, in the same manner exactly as in the experiment just described. Steam is allowed to pass freely from the boiler through the tubes and cylinder, and makes its escape finally through a valve or cock provided for that purpose, until at length all the atmospheric air is blown from the machine. The cock is then closed, and pure steam only fills every part of the engine. A chamber, called a *condenser*, which is maintained at a low temperature, by being immersed in cold water, is made to communicate with both ends of the cylinder by means of proper tubes and valves. When the piston is required to descend, the communication between this chamber and the bottom of the cylinder is opened, while a communication is at the same time opened between the boiler and the top of the cylinder. The steam which fills the cylinder below the piston rushes toward the condenser by its elastic force, and is there immediately converted into water by the cold medium with which it is surrounded. The cylinder below the piston, therefore, remains a vacuum; meanwhile the steam, rushing from the boiler above the piston, forces it downward, until it reaches the bottom of the cylinder. The communication between the boiler and the top of the cylinder is now closed, and a communication opened between the boiler and the bottom of the cylinder, and at the same time the communication between the condenser and the bottom of the cylinder is closed, and a communication is opened between the condenser and the top of the cylinder. Under these circumstances, the steam which is above the piston rushes by its elastic force toward the condenser, where it is condensed, and the cylinder above the piston remains a vacuum. Meanwhile the steam from the boiler, rushing into the cylinder below the piston, forces it upward, and the piston ascends to the top of the cylinder; and in the same way the alternate motion of the piston upward and downward in the cylinder is continued.

The results of experimental inquiry, as we have seen, justify us in assuming as a universal law, that by the application of a sufficient quantity of heat all solids may be converted into liquids; and, by the abstraction of a corresponding quantity of heat, all liquids may be converted into solids. We have likewise seen, that, by the supply of heat in sufficient quantities, all liquids may be converted into the vaporous or gaseous form; and analogy would lead us to infer, that, by the due abstraction of heat, the bodies that exist in the gaseous form might be reduced to liquids. The practical results here, however, fall far short of the anticipations to which analogy leads us. There is a numerous class of bodies existing in the gaseous form, among which atmospheric air may be mentioned as the most obvious, which no means hitherto known have converted into liquids. Arguments, however, similar to those which led us to infer that charcoal and alcohol are not real exceptions to the liquefaction of solids, and the solidification of liquids, but that they transcend the power of

art, without falling beyond the limits of the general law, lead to similar conclusions respecting the more numerous class of bodies called *permanent gases*.

Bodies existing in the aeriform state are divided into two classes, called *vapors* and *gases*. Vapors are those aeriform substances which are known to have been raised from liquids by the application of heat, and which may always be restored to the liquid form by the due abstraction of heat. On the other hand, gases are those aeriform bodies which have never been known to exist in any other than the aeriform state, and which, under all ordinary degrees of cold, preserve their elastic form. This class includes common air, and a great number of substances known in chemistry under a variety of names, but all comprised under the general denomination of *gases*. The exact correspondence of the mechanical properties of these bodies with those of vapors raised from liquids by heat, naturally leads to the suspicion that they are, in fact, vapors of bodies which vaporize at extremely low temperatures—at temperatures lower than any which we generally attain even by the processes of art. Such a supposition is perfectly consistent with all the effects which we observe; for such bodies would then maintain all the gaseous quantities which they are observed to possess at present, though they should be true vapors capable of being condensed, and even solidified, if we possessed practical means of depriving them of a sufficient quantity of the heat which they contain.

These observations derive considerable probability and force from the results which the improved powers of science have more recently furnished. In proportion as more powerful means of extorting heat from gases have been invented, a greater number of them have been forced within the limits of the law of condensation. The substance called ammonia was known only as a gas until a temperature of -46° was attained. Exposed to that temperature, it became a liquid. Such a body, in high northern latitudes, would, at different seasons, exist in the different forms of liquid and gas; in winter it would be liquid, and at other seasons gas.

Since it is certain that gases may lose a considerable quantity of heat, without undergoing any degree of condensation, we must look upon them as vapors; which, besides the sum of the latent and sensible heat necessary to sustain them in the elastic form, have, subsequently to attaining that form, received a large accession of heat; and yet, from their nature, with all this supply of heat, their temperature does not exceed the ordinary temperature of the globe. It would be necessary to abstract from them all the heat which they have received subsequently to taking the vaporous form before condensation could begin. As our power of producing artificial cold is, however, very limited, never having yet exceeded -100° (if, indeed, that limit has been attained), it cannot be surprising that all the redundant heat contained by gases, over and above the sum of latent and sensible heat necessary to maintain them in the elastic form, should not have been extracted by this means.

Some facility in the attainment of this object may be gained by a knowledge of the fact that the mechanical compression of a gas raises its temperature. If, therefore, a permanent gas be submitted to severe mechanical compression, its temperature will be raised, and the heat which it contains may be more easily withdrawn from it, and imparted to freezing mixtures, or extorted by any of the usual means of exposing it to extremely low temperatures. By continually carrying on the process of compression, additional quantities of heat may be developed and withdrawn, so that at length we may succeed in reducing the quantity of heat contained in the gas to that sum of latent and sensible heat which seems the limit of the quantity necessary to maintain the elastic form. Any further reduction would be necessarily followed by condensation.

Means similar to these have accordingly been applied, and succeeded, in the hands of Faraday. By submitting gases in small quantities, in strong glass tubes, to a severe pressure, produced by their own elasticity, and the force with which they were generated by chemical action, heat was extracted in considerable quantities, and was carried off by evaporation from the external surface of the glass. In this way these gases were condensed into the liquid form.

Faraday attempted, without success, the condensation of various other gases by the same means. Oxygen, azote, and hydrogen, have, it is said, been submitted to a pressure of eight hundred atmospheres without passing to the liquid state.*

It appears, therefore, that, in proportion as the powers of science are advanced, the exceptions to the general law of condensation become more and more circumscribed; and it is not, perhaps, overstepping the limits of justifiable theory to assume, as a general law, that all bodies whatever, existing in the gaseous form, may, by a sufficient abstraction of heat from them, be reduced to the liquid state.

The absorption of heat, in the process by which liquids are converted into steam, will explain why a vessel containing a liquid, though constantly exposed to the action of fire, can never, while it contains any liquid, receive such a degree of heat as might destroy it. A tin-kettle containing water may be exposed to the action of the most fierce furnace, and yet the tin, which is a very fusible metal, will remain uninjured; but if the kettle without containing water were placed on a fire, it would be immediately destroyed. The heat which the fire imparts to the kettle is immediately absorbed by the bubbles of water, which are converted into steam at the bottom, and rendered latent in them. These bubbles ascend through the water, and escape at the surface, continually carrying with them the heat conveyed from the fire through the bottom of the kettle. So long as water is contained in the kettle, this absorption of heat by the steam continues; and it is impossible that the temperature of the kettle can exceed the temperature of boiling water. But if any part of the kettle not filled with water be exposed to the fire, there being then no means of dismissing the heat which it receives from the fire, the metal will presently melt, and the vessel be destroyed.

The latent heat of steam may be used with great convenience for many domestic purposes. In cookery, if steam raised from boiling water be allowed to pass through meat or vegetables, it will be condensed upon their surfaces, imparting to them the heat latent in it before its condensation, and they will thus be as effectually boiled as if they were immersed in boiling water.

In dwelling-houses where pipes convey cold water to different parts of the building, steam-pipes carried from the lower part will enable hot water to be procured in every part of the house with great speed and facility. The cock of a steam-pipe being immersed in a vessel containing cold water, the steam which escapes from it will be condensed by the water, and will very speedily, by imparting to it its latent heat, cause it to boil. Warm baths may thus be prepared in a few minutes, the water of which would require a long period to boil.

From all that has been explained in the present discourse, it will be apparent that the solid, liquid, and gaseous states are not necessarily connected with the essential properties of the bodies which assume these states respectively.

* An opinion, which I consider to be erroneous, has hitherto prevailed, that gases and vapors may be condensed by mere mechanical compression. I conceive that mechanical compression contributes in no other way to the condensation of a gas or a vapor, than so far as it is the means of raising the temperature of the gas compressed, and therefore facilitating the process by which it may be deprived of heat.

Water, whether it exist in the state of liquid, in the state of steam, or in the state of ice, is evidently the same substance, composed of the same elements, and possessing properties in all respects the same, except in those mechanical effects which are immediately connected with the three states just mentioned. In fact, the state in which water may be found is a mere accident consequent on the surrounding temperature; nor can one rather than another state with propriety be called the *natural state* of the body.

If the expression *natural state* have any meaning, it must be that state in which the substance is most commonly found; and in that sense the natural state of water in different parts of the globe is different.

The variations of temperature incident to any part of our globe are included within no very extended limits; and these limits determine the bodies which are found to exist most commonly in the several states of solid, liquid, and gas. A body whose boiling point is below the lowest temperature of the climate, must always exist in the state of vapor or gas, and one whose melting point is above the highest temperature incident to the climate must always exist in the solid form. Bodies whose melting point is below the lowest temperature of the climate, while their boiling point is above the highest temperature of the climate, will permanently exist in the liquid form. The permanent gases afford examples of the first-mentioned class. Most solid bodies are examples of the second; and such fluids as mercury are examples of the third. A liquid whose melting point is a little above the lowest limit of temperature will generally exist in the liquid state, but occasionally in the solid. Water is an example of this. A liquid, on the other hand, whose boiling point is a little below the highest limit of temperature, will generally exist in the liquid form, but occasionally in the gaseous. Ether, in hot climates, is an example of this. Its boiling point is 98° ; and it could not exist, at certain seasons of the year, in the liquid form, in India and other hot countries.

Some bodies are at present retained in the liquid form only by the atmospheric pressure. Ether and rectified spirits of wine are examples of this. If these liquids be placed under a receiver of an air-pump, and the pressure of the air be partially removed, they will be observed to boil at the ordinary temperature of the air; whence it appears, that, if the pressure of the atmosphere were considerably less than it is, these substances would have existed only as permanent gases.

Great convulsions of nature, such as earthquakes, volcanic effects, and the like, by which extraordinary quantities of heat are evolved, form exceptions to this uniform state; and the effects of such exceptions are discoverable upon and beneath the surface of the earth: but, under ordinary circumstances, the states of gases or airs, of liquids, and of solids, are determined by the condition just mentioned, namely, by the relation which their boiling and freezing points bear to the extreme limits of the temperature of our climate.

These considerations will lead us to perceive what would be the effect, if the earth's distance from the sun were to undergo considerable change, either by increase or diminution, other circumstances being supposed to remain the same. If its proximity to the sun were increased, the increased influence of solar heat would render it impossible for many substances now commonly liquid on the surface of the earth to exist in any other state than that of air; and, at the same time, many solid bodies would be incapable of maintaining the solid form, and would become permanently liquid. It would be possible, under such circumstances, that the water which now constitutes the ocean would be changed into an atmosphere, and that many of the metals which now exist in the solid form, distributed through the earth, would become liquid, and fill the beds of the sea. If, on the other hand, the distance from the sun were

considerably increased, the solar heat would undergo a corresponding diminution, and many of the substances which now assume the liquid form would then become solid. The sea which surrounds the globe would take the form of a mass of solid crystal. Substances now in the gaseous state might be reduced to the form of a liquid; nay, that the atmosphere should be converted into a sea by a sufficient diminution of temperature, is an effect not only within the bounds of possibility, but probable upon the clearest and best-founded analogy.

In reviewing what has been stated in the present discourse, it will be perceived that the following general facts have been established, which form the basis of all investigations concerning the phenomena of the conversion of liquids into vapor by ebullition:—

1. A liquid, when raised to a certain temperature, boils, and is converted into vapor. The boiling point of a liquid varies with the pressure to which it is submitted: the greater this pressure, the greater will be the temperature at which the liquid boils.
2. During the process of ebullition no increase of temperature takes place, though a considerable portion of heat is imparted to the boiling liquid.
3. Different liquids undergo the process of ebullition under the same pressure at different temperatures; and the temperature at which a liquid boils under the medium pressure of the atmosphere, or thirty inches of mercury, is called its *boiling point*.
4. Different liquids absorb different quantities of heat in the process of ebullition.
5. The elastic force of the vapor into which a liquid is converted is equal to the pressure under which the liquid boils.
6. The states of liquid or vapor are not essentially connected with the nature of bodies, but are merely accidental on the temperature to which bodies are exposed, nor does a body change its nature or essential properties in passing from the one state to the other.

COMBUSTION.

Flame produced by chemical Combination.—Supporters of Combustion and Combustibles.—Oxygen chief Supporter.—Heat of Combustion.—Flame.—Its illuminating Powers.—Combustion without Flame.—Property of spongy Platinum.—Table of Heat evolved in Combustion.—Theory of Lavoisier.—Of Hook and others.—Electric Theory.

Faint, illegible text located in the lower right quadrant of the page, possibly bleed-through from the reverse side.

COMBUSTION.

MANY examples have been presented, in which the chemical combination of two bodies was accompanied by a change of temperature. When sulphuric acid and pure water are mixed together at the same temperature of 60° , the mixture will suddenly rise to the temperature of boiling water. In like manner, when snow at the temperature of 32° is mixed with common salt at the same temperature, the compound resulting will fall many degrees below the common temperature of the constituents. It may be taken, therefore, as a general principle, that chemical combination is one of the numerous causes by which heat may be developed or absorbed. Every part of chemical science abounds in facts illustrative of this principle.

We have seen that an extreme increase of temperature is attended by the presence of light. Now, if these two general laws be placed in juxtaposition, it may be expected that, if chemical combinations can be discovered in which extreme quantities of heat may be developed, the product may attain that temperature at which it will be luminous.

Such are the principles which form the foundation of the ordinary process of *combustion* or *burning*. When fire is produced, such a combination always takes place between the particles of two bodies as produces a development of heat so extreme as to produce light. If the body emitting light in this case have the solid form, the effect is called *fire*; but if it be vapor, it is called *flame*.

It so happens that, among the infinite variety of natural substances by the combination of which this remarkable phenomenon is produced, one of the two combining bodies is, almost in every case, the substance called in chemistry oxygen gas; and that in the few cases where oxygen is not present there is a very limited number of other substances, one or the other of which must be one of the combining substances.

Among these other substances, the principal are three bodies, called in chemistry *chlorine*, *bromine*, and *iodine*.

Some one of these four bodies—oxygen, chlorine, bromine, and iodine—being, almost in every case, one of the two bodies by the combination of which combustion is produced, and the other bodies with which they severally combine being far more numerous, the four just mentioned are distinguished relatively to the phenomena of combustion by the name *supporters of combustion*; while the other body forming the combination with them, whatever it may be, is called a *combustible*. These terms, however, must be carefully understood as not expressing any distinct or different mode of action which the two combining bodies exert in the process of their combination. *Supporters of combustion* and *combustibles*, as far as has been discovered, have no other difference than this, that the former are very limited in number, and the latter very numerous.

Exclusive of the four supporters of combustion, every simple substance known in chemistry are *combustibles*, except *azote* or *nitrogen gas*. The meaning of this is, that all simple substances are capable of entering into combination with one or other of the four bodies called oxygen, chlorine, bromine, or iodine, in such a manner as to be attended with a sudden evolution of light and heat.

After the discovery of the true nature of the process of combustion, it was long supposed that the only supporter of combustion was oxygen, and the phenomenon of combustion was consequently defined to be the rapid combination of oxygen with some other substance. This is, indeed, the nature of the phenomenon in all ordinary cases of combustion; and it is only in few instances, developed by the researches of modern chemists, that chlorine and the other supporters play a part.

The tendency which a body heated considerably above the temperature of the surrounding medium has to dismiss its heat, whether by contact or radiation, renders it necessary that the combination which produces combustion should be so rapid as to be almost instantaneous; for, if the heat developed were produced progressively, it would be progressively dissipated, and could never accumulate so as to produce that increased temperature which is necessary for the evolution of light.

In all ordinary cases of combustion, one of the combining bodies is the oxygen, which forms a component part of atmospheric air; and one of the circumstances which most favor combustion is the fact that the constituent elements of atmospheric air are mixed together, either mechanically, or, if they be chemically combined, their affinity is of the weakest imaginable kind. Thus the oxygen exists in the atmosphere almost in a free state, and ready to combine with any object which presents to it the slightest affinity. The application of heat to any body, by weakening the energy of the cohesive principle, leaves its particles more free to obey other affinities; and consequently it is found that bodies which cannot combine at one temperature will frequently be capable of combining when the temperature of one or both is raised. A body, therefore, may exist at a certain temperature, when surrounded by the oxygen of the atmospheric air; but if the temperature of that body be raised, the affinity of its molecules for those of oxygen will at length be enabled to take effect by the diminution of the force by which its particles are held together. In conformity with this principle, we find that when a combustible is raised to a certain temperature, its particles rapidly combine with those of the oxygen contained in the surrounding air. In their combination heat and light are evolved, and fire is produced. When phosphorus is raised to the temperature of 148° , it burns with great splendor. The particles of the phosphorus, in this case, combine with those of the oxygen in the atmosphere, and so much heat is developed by their combination that the light is evolved. The temperature necessary to each different substance, to combine with the oxygen and produce com-

bustion, is very different. Hydrogen gas requires a heat equal to that of incandescence to cause it to begin to burn. Wood, coal, and other combustibles, burn when raised to various temperatures.

According to the experiments of Sir Humphry Davy, the temperature necessary to enable the following substances to combine with oxygen vary in the order in which they stand, the first being that which burns at the lowest temperature, and the succeeding ones at temperatures gradually increasing :—

Phosphorus,
Phosphuretted hydrogen gas,
Hydrogen and chlorine,
Sulphur,
Hydrogen and oxygen,
Olefiant gas,

Sulphuretted hydrogen,
Alcohol,
Wax,
Carbonic oxide,
Carburetted hydrogen.

The experimental proofs by which combustion is shown to arise from the combination of oxygen with other principles consist of the whole range of one department of chemical science. We may, however, offer an experiment as an example of this species of demonstration.

Let a short earthenware tube be filled with a coil of iron wire, the weight of which has been previously ascertained. Let one extremity of this tube be connected with a bladder filled with oxygen gas, the weight of which is known; and let the other extremity be connected with a flaccid bladder, the weight of which, including the air which it contains, is also exactly known. Let the porcelain tube and its contents be raised to incandescence by the application of heat, and let the oxygen contained in the bladder be then forced through the tube in contact with the wire. The wire in this case will burn, and be rapidly oxidised, and the product will be the *oxide of iron*. When this product is weighed, it will be found to be heavier than the iron; and when the two bladders and their contents are weighed, they will be found to be lighter than before, by exactly the weight which the iron has gained; the oxygen, therefore, which has been lost by air contained in the bladders, has been combined with the iron during the process of combustion.

Flame is gas heated to whiteness by the heat produced by the combustion of volatile matter. When a candle burns, the tallow or wax of which it is composed is first liquefied, and then drawn up through the interstices of the wick by capillary attraction. As it comes in contact with the source of heat, it is boiled and converted into vapor; this vapor ascends in a column by reason of its lightness, and is now raised to the temperature which enables it to form a combination with the oxygen of the surrounding air. This combination instantly and copiously develops heat, which, being communicated to the surrounding current of gas, renders it luminous, and produces the white, bright light of the flame. It will be apparent, from this, that the light from the flame can only exist on its exterior surface, which is in contact with air. The flame of a candle or lamp is, therefore, so far as regards heat, hollow; or rather it is a column of gas, the exterior surface of which is luminous, while the interior is non-luminous. As the gas in the interior of the flame ascends, it gets into contact with a fresh portion of the atmosphere, from which it receives a supply of oxygen, by combination with which heat is evolved, which produces light. As the gas ascends from the centre of the flame, it comes successively into contact with the air, and in this manner becomes luminous, until at length the column is reduced to a point. Thus the flame of a candle or lamp gradually tapers to a point, until all the gas produced from the boiling matter in the wick receives its due complement of oxygen from the air, and passes off. It speedily loses the temperature necessary to render it luminous, and the flame terminates.

The light produced by lamps or candles formed of different substances has different illuminating powers, according to the quantities of light evolved by the combination of the gas or vapor with oxygen.

The vapor of some substances is capable of combining with oxygen at a temperature below that which is necessary for the production of flame. Sir Humphry Davy coiled a piece of platinum wire round the wick of a spirit-lamp, and, having lighted the lamp, and allowed it to burn till the wire became red hot, he then extinguished it; the wire, however, with the heat which it had acquired, communicated a sufficient heat to the vapor raised from the alcohol to enable it to combine with the oxygen of the surrounding air: and a slow combustion, without flame, was thus produced. This process of combustion might be continued for any length of time, or as long as the alcohol in the lamp could supply vapor.

The product obtained by the combination of oxygen and the vapor of alcohol in this case was of a nature altogether different from that obtained by the ordinary combustion of the spirit-lamp. Acetic acid forms a part, but not the whole of the product.

There are other vapors which, like that of alcohol, are susceptible of combustion without flame. Among these are the vapors of ether, camphor, and some of the volatile oils.

If platinum wire, heated to redness, be introduced into a receiver containing a mixture of coal gas, or the vapor of ether, and atmospheric air, it will continue red hot until the whole of the gas is consumed. In this case the gas combines with the oxygen of the atmospheric air with which it is mixed, and combustion takes place.

Dr. Thomson accounts for this process by the fact of the small specific heat and bad-conducting power of platinum: a small quantity of heat is sufficient to make it red hot, and, being a bad conductor, it loses little heat during the process. Platinum, at a red heat, has a sufficiently high temperature to produce a rapid combination of the vapor of alcohol with oxygen, but it is not sufficient for the production of flame.*

If a jet of hydrogen gas be projected on a small mass of spongy platinum, the platinum will become red hot, and will continue so as long as the jet plays on it. This forms an easy means of producing an instantaneous light, and an apparatus is constructed in a convenient form for this purpose. By turning a stopcock, the jet of gas is thrown on a small cup containing platinum, which, immediately becoming red hot, is capable of lighting a match. The same effect may be produced by a jet of the gas projected on other substances, such as palladium, rhodium, and iridium. Some others, also, such as osmium, would be attended with a like effect, if their temperatures were previously raised. Platinum foil would not, under these circumstances, redden; but, if it be crumpled, like paper, it will undergo the same effect as the spongy platinum.

These effects have been accounted for by the fact that spongy platinum, and other substances in a similar state, have such an affinity for oxygen gas, that their capillary attraction produces the absorption of that gas from the atmospheric air into their pores, in which it is sometimes collected even in a condensed state. It is probable that spongy platinum contains within its pores a considerable quantity of condensed oxygen gas. Charcoal is known to absorb by its capillary attraction nine times and a quarter its own bulk of oxygen; and, when placed in contact with hydrogen gas, the oxygen absorbed combines with the hydrogen, and forms water. The jet of hydrogen gas projected on a

* Thomson on Heat, p. 311.

spongy platinum probably combines with the oxygen held in its pores, and the heat developed by the combination renders the platinum red hot.*

The determination of the quantity of heat produced in the combustion of different substances is a matter not only of great scientific interest, but of considerable importance in the useful arts and manufactures. The mutual relation between the quantity of the combustible, and of the oxygen combined with it, and the heat developed, if accurately ascertained for various combustibles, could not fail to throw light, not only on the theory of combustion, but, probably, on the nature of heat in general. In the arts and manufactures, as well as in domestic economy, the due selection of combustible matter depends, in a great degree, on the quantity of heat or light developed by a given weight of it in the process of combustion.

Nevertheless, there is no subject in experimental physics in which more remains to be discovered, and in which the process of discovery is more difficult, than in the determination of the quantity of heat developed in the combustion of various substances. Experiments have been made on some combustibles by Lavoisier and Laplace with their calorimeter. A few others have been made by Dalton. Crawford and Count Rumford have also made some experiments on this subject. The method of Lavoisier and Laplace consisted of burning the combustible within the calorimeter, and measuring the quantity of ice melted by the heat which it developed. Dalton placed a given weight of water, at a known temperature, in a tinned vessel. Having previously ascertained the specific heat of this vessel, that of water being known, he applied the burning matter to the bottom of it, so as to cause it to impart its heat to the water. The quantity of heat developed was measured by the increased temperature of the water, and the vessel which contained it. This process would evidently give results considerably below the truth, because it is impossible that all the heat developed in the combustion could be imparted to the vessel; some would be necessarily communicated to the surrounding air without reaching the vessel, and more would be dispersed by radiation. Dr. Crawford contrived to surround the burning matter with water, by the increased temperature of which he measured the heat developed.

Sir Humphry Davy made experiments to determine the heat developed by some gases in the process of combustion, and adopted a method of experimenting differing little from that of Dalton. He caused the flame to act on the bottom of a copper vessel, containing a given weight of oil raised to a given temperature, and estimated the heat produced in the combustion by the increased temperature received to the oil. The following are the results obtained by these experiments:—

Substances burned in one pound.	Oxygen consumed in pounds	Ice melted in pounds.			
		Lavoisier.	Crawford.	Dalton.	Rumford.
Hydrogen	7.5	295.6	480	320	
Carburetted hydrogen	4.0			85	
Oleiant gas	3.5			88	
Carbonic oxide	0.58			25	
Olive oil	3.0	149.0	59	104	94.07
Rape oil	3.0				124.10
Wax	3.0	133.0	97	104	126.24
Tallow	3.0	96.0		104	111.58
Oil of turpentine				60	
Alcohol	2.0			58	67.47
Sulphuric ether	3.0			62	
Naphtha					107.03
Phosphorus	1.33	100.0		60	97.83
Charcoal	2.66	96.5	69	40	
Sulphur	1.0			20	
Camphor				70	
Caoutchouc				42	

* Thomson on Heat, p. 315.

The great discordance which is apparent between the results of these experiments shows how much still remains to be done in this department of the physics of heat. It is probable, however, that the results of the experiments of Lavoisier and Laplace are more entitled to confidence than those of the other experimenters. Dr. Thomson thinks that it is probable that one pound of hydrogen gas gives out in combustion as much heat as would melt 400 lbs. of ice, or 56,000° of heat.

The copious development of heat, in the process of combustion, and the consequent luminous effect, were accounted for by Lavoisier by the fact that a condensation of matter took place. Thus, when a gaseous substance, by the process of combination with oxygen, passes into the liquid or the solid state, all the latent heat which maintained it in the form of gas suddenly becomes sensible, and an immense increase of temperature necessarily ensues. The same effect takes place when a liquid passes into the solid state. Now it is certain that in numerous cases of combustion these effects take place; and all such cases admit of being reduced to the same class of phenomena as the solidification of a liquid, or the condensation of a vapor, in both of which cases, as has been already explained, heat is evolved. Some of the phenomena of combustion may, perhaps, be reduced to the case of ordinary condensation without change of form; but there are instances which do not seem to fall under this class of effects. On the contrary, in certain cases, solids or liquids, in the process of combustion, pass into the state of gases. Thus, when gunpowder is exploded, the oxygen, which is contained abundantly in the saltpetre, combining with the sulphur and carbon, which are the other constituents of this substance, assumes the gaseous form. At the same time a highly elastic fluid is produced, as well as a large quantity of heat and light.

So far, therefore, as the theory of Lavoisier assumes that combustion is the consequence of rapid chemical combination, and that such combination is accompanied by a copious evolution of heat and light, it is strictly a statement of fact, but when it is attempted to reduce these facts to the general class of phenomena, in which heat and light are developed by condensation, the theory fails, because all the phenomena which it professes to explain cannot be reduced to this class. It is also assumed, in the theory of Lavoisier, that oxygen is a compound of heat, light, and a certain unknown base; that a decomposition takes place by which the heat and light are disengaged, and the unknown base is combined with the combustible. Now the existence of this unknown base is a gratuitous assumption, inasmuch as such a base has never been exhibited in a separate form; besides which, it is assumed that light and heat are bodies, and not qualities of matter, which is still undecided.

So remarkable a phenomenon as combustion, and one so susceptible of such various and important practical applications, could not fail, at an early period, to attract the attention of chemists. We accordingly find many theories propounded at various epochs in the history of chemistry for its explanation. One of the earliest of these theories assumes the existence of a first principle, or elementary substance, called *fire*, which had the property of devouring other bodies. According to this theory, combustion was the process by which the combustible was converted into fire; whatever part of the combustible was unsusceptible of this conversion remained behind in the form of ashes.

Dr. Hook traced the phenomena of combustion to the solvent power over the combustible possessed by a principle found in atmospheric air, similar to one which exists still more copiously in nitre. How near this ingenious hypothesis approached to the true principle of combustion may be easily perceived. But the theory which took possession of the scientific world, to the exclusion of all others, for a long period, was the Stahlian theory of *Phlogiston*. In this

theory, the phenomenon of combustion was explained by assuming the existence of a body called *phlogiston*, which was supposed to be a constituent element of all combustibles. The process of combustion consisted in the sudden separation of phlogiston from the combustible; and this separation was accompanied by the heat and light which characterized the phenomenon. Some succeeding philosophers regarded this phlogiston as light maintained in bodies, as it were, in the latent state, and with its ordinary concomitant heat. Dr. Priestley and others discovered that the atmospheric air in which combustion takes place becomes incapable of permitting the same phenomenon to be repeated in it, and likewise that such air was rendered incapable of supporting animal life. He inferred that atmospheric air had an affinity for phlogiston, and that its presence was necessary, in order to effect the extrication of phlogiston from the combustible, and, consequently, that the presence of atmospheric air was essentially necessary to combustion; but that when the atmospheric air became saturated with the phlogiston which it received during the process of combustion, the same air, being incapable of combining with any greater quantity of phlogiston, was incapable of sustaining the process of combustion.

Still the phlogistic theory labored under the capital defect, that the existence of phlogiston as a separate principle was never proved; and, in fact, that the assumption of its existence had no other foundation than its convenience for the solution of the phenomena of combustion. This defect in the theory of Stahl was attempted to be removed by a bold assumption of Kirwan, viz., that phlogiston was no other substance than hydrogen. The necessary consequences of the adoption of such an hypothesis were, that hydrogen is a component part of every combustible body; that combustion consists in the decomposition of the combustible into the hydrogen and its base; that, after issuing from the combustible, the hydrogen combines with the oxygen of the atmospheric air. Such were the bases of the Kirwanian theory.

Matters were now ripe for the discovery of Lavoisier. Hook had held that a principle in atmospheric air, identical with the prominent element of salt water, was a solvent for all combustibles; that the solution effected by it was accompanied by heat and light. Kirwan held, that a combination of a certain element of the combustible with the oxygen of the atmospheric air was the cause of combustion. Lavoisier, rejecting what was superfluous in these theories, at once assumed that combustion was caused by the combination of the oxygen of the atmosphere, not with hydrogen, or with the imaginary substance of phlogiston, but with the *combustible itself*, and that in such combination heat and light were produced. He accounted for the phenomena by two admitted chemical laws: first, that the chemical affinity of bodies for each other is awakened by the elevation of temperature of one or both; and, secondly, that a body, in passing from the gaseous to the liquid or solid state, produces an abundant evolution of heat. The combustible, therefore, when raised to a certain temperature, is brought to the state in which its chemical affinity for oxygen is capable of taking effect. The oxygen in combining changes its form, and disengages a large quantity of latent heat.

This theory was quickly embraced by Berthollet, Fourcroy, Morveau, and other leading chemists of the times, and has since been very generally received. There are, however, as has been already stated, some phenomena connected with combustion which it fails to explain. These are the cases where, in the combustion, the change of form is the reverse of that which, according to the theory of Black, would cause a development of heat. When the combining substances previously exist in a solid state, and during combustion pass into the gaseous state, we should expect a large absorption of heat, instead of a considerable evolution of this principle.

This defect in the theory has given rise to another, which has been proposed by Sir Humphry Davy. According to this theory, the phenomena of affinity are the consequences of bodies existing in different states of electricity. It is known that bodies when oppositely electrified attract each other, and when similarly electrified repel each other. If the molecules of two bodies be oppositely electrified, and be so placed that they can act on one another, their effects will be attraction, the energy of which will be increased in a rapid proportion with the diminution of their distance. The more intensely one is positively electrified, and the other negatively, with so much the greater force will they combine, and the phenomena of combustion will be exhibited in their union. Oxygen is in an intensely negative state of electricity, and hydrogen intensely positive. Hence they combine with a great evolution of heat.

HOW TO OBSERVE THE HEAVENS.

Interesting Nature of the Subject.—Diurnal Rotation.—Circumpolar Stars.—*Ursa Major*.—Forms of the Constellations.—The Pointers.—The Pole-Star.—*Cassiopeia*.—Capella.—The Swan.—Equatorial Constellations.—*Orion*.—*Sirius*, or the Dogstar.—*Aldebaran*.—*Procyon*.—*Auriga*.—*Columba*.—Herschel's Observations on *Sirius*.—Dr. Wollaston's Observations.—Aspect of the Heavens at different Seasons of the Year.—Uses of the Celestial Globe.—To ascertain the Aspect of the Heavens on any Night—at any Hour.—Effect of the Telescope on Fixed Stars.—Relative Brightness of the Stars.—Theory of refracting and reflecting Telescopes, as applied to the Stars.—Manner in which Sir W. Herschel applied it.—Method of estimating the Brightness of small Stars.—Method of observing variable Stars.—Double Stars.—Description of the Micrometer.

1701

1701
1702
1703
1704
1705
1706
1707
1708
1709
1710
1711
1712
1713
1714
1715
1716
1717
1718
1719
1720
1721
1722
1723
1724
1725
1726
1727
1728
1729
1730
1731
1732
1733
1734
1735
1736
1737
1738
1739
1740
1741
1742
1743
1744
1745
1746
1747
1748
1749
1750
1751
1752
1753
1754
1755
1756
1757
1758
1759
1760
1761
1762
1763
1764
1765
1766
1767
1768
1769
1770
1771
1772
1773
1774
1775
1776
1777
1778
1779
1780
1781
1782
1783
1784
1785
1786
1787
1788
1789
1790
1791
1792
1793
1794
1795
1796
1797
1798
1799
1800

HOW TO OBSERVE THE HEAVENS.

To all persons in whose minds a taste for the study of the universe has been awakened, there is no spectacle which affords an interest so intense as that which the firmament offers on every clear night, and no occupation is more delightful to those endowed with the slightest contemplative habits, than from time to time through the year to observe the changes which take place in the aspect of that glorious scene; but to render such contemplations still more agreeable, and to enable the spectator to turn his observations to profitable account, it will be necessary that he should be familiar with the objects which there present themselves in such countless numbers and endless variety.

It is an error to suppose that astronomical observations must be confined to observatories, or that no one can enjoy practical astronomy who is not supplied with telescopes and other optical and astronomical apparatus. Our Maker has given us, in the eye, an optical instrument of exquisite structure, and has supplied us with an understanding by which its application may be guided to the most sublime speculations. We shall on the present occasion endeavor to give such plain and elementary rules as may enable every one by the mere use of his eyes, without even resorting to a common telescope, to occupy himself advantageously in the contemplation of the heavens.

If a person, on a clear starlight night, turn his face directly to the north, and contemplate the heavens for an hour or two, he will observe stars continually to rise from the horizon on his right, or in the east, and other stars to disappear and set on his left, or in the west. The stars scattered over a portion of the firmament which lies immediately above the northern horizon are observed never to set, but alternately to rise on the eastern and to descend on the western side of the northern point; the extent of their descent, however, being so limited, that they never descend so low as the horizon. Frequent and attentive observation of these appearances will suggest strongly the idea that these objects revolve in circles round some point as a centre, which is situate in the northern region of the firmament. But this impression can not

be verified by ocular observation merely, and still less can the position of that common centre be thus determined.

Having recourse, however, to instruments, by which the exact elevations of the stars may from time to time be observed, and their exact bearings noted, data are obtained by which it is demonstrated that this first impression is rigorously correct; that the objects which glitter on the firmament do, in fact, appear to revolve round a certain point as a common centre: that they all complete their revolution round that point in twenty-three hours, fifty-six minutes, four seconds, and nine hundredths of a second. All the stars complete their revolution round this point in exactly the same time, however different their distances from it may be, and as they so revolve they preserve their relative position with respect to each other. It has been shown on a former occasion that this appearance is an optical illusion, caused by the rotation of the earth upon its axis.

At the point which is the common centre of this motion, and which is called the north celestial pole, no star is found; but there is a star sufficiently bright to be distinctly visible to the naked eye very close to it, which is therefore called the **POLE-STAR**. The method of recognising this star we shall presently explain.

Even the most inattentive observer, when assuming the position we have here described, will be immediately struck with a combination of seven conspicuous stars arranged in the relative positions exhibited in the annexed diagram.

Fig. 1.

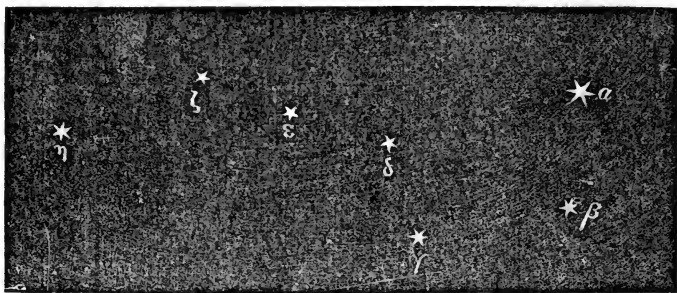

This combination, or group of stars, presents to us the first and most striking example of what is called a **CONSTELLATION**.

The peculiar configurations affected by this and other groups scattered over the firmament, give an impression that some physical relation connects the component stars with each other. But a more exact acquaintance with stellar astronomy proves that such impression is destitute of any good foundation. The stars which compose the constellations are casually scattered over the firmament, and it is the imagination only, which groups them and invests the collections thus associated with the fanciful figures of bears, lions, goats, dogs, warriors, and mythological personages. Unreasonable as such a system must be allowed to be, it is not without its use as a means of reference, and an artificial aid to the memory. That a better system of signs and symbols might have been devised for these purposes may be admitted; but when it is considered that the names and forms of the most conspicuous constellations have had their origin in remote antiquity—that they were handed down from the Chaldeans to the Egyptians, and from the Egyptians to the Greeks, and from these to the moderns—that they are referred to in the works of every

past astronomer, and engraved on the memory of every living observer—it will be readily acknowledged that, even if a general change of stellar nomenclature and symbol were practicable (which it assuredly is not), it would be neither advantageous nor advisable.

The northern constellation, to which we have referred, is called *Ursa Major*, or *the Great Bear*. The seven stars are only the most conspicuous of those which compose it, the entire number of stars in it being eighty-seven, most of which, however, are so small as not to be visible without a telescope. Of the seven principal stars one only (that marked α , fig. 1), is of the first magnitude. Three (marked β , γ , and η), are of the second magnitude, and the remaining three (δ , ϵ , and ζ) are of the third magnitude. As these stars, being

Fig. 2.

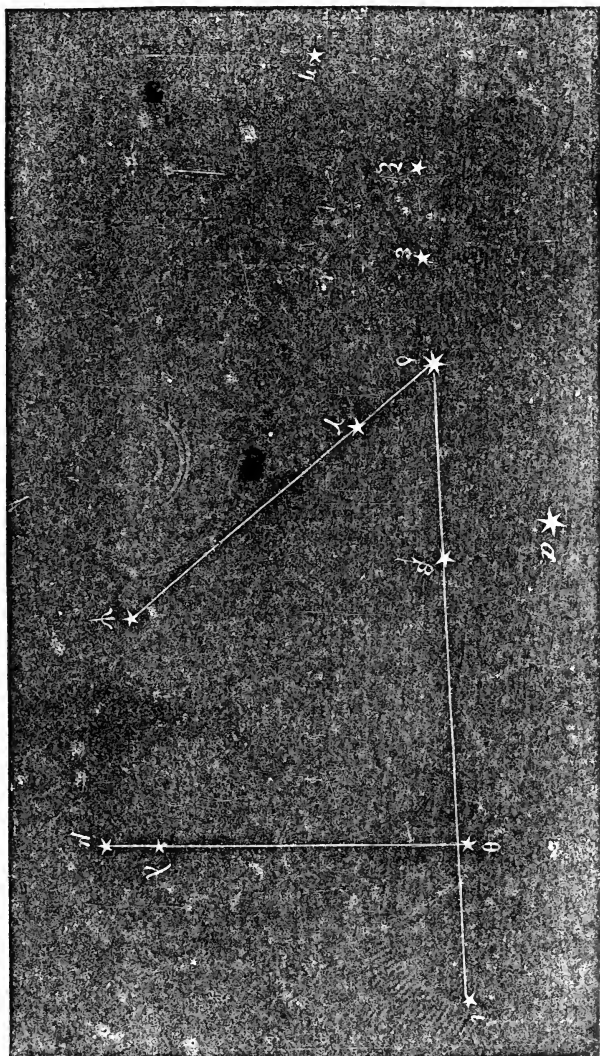

visible at all seasons, and in all northern latitudes, are necessarily familiar to every eye, they may serve as standards or moduli by which the astronomical amateur may estimate the different orders of magnitudes of the stars generally.

One of the most convenient methods of ascertaining and identifying the principal stars on the heavens which the amateur observer can adopt, consists in selecting other known stars as *pointers*. We shall explain this method by one or two examples. In the constellation of *Ursa Major*, there are besides the seven stars above mentioned, five others of the third magnitude, which are marked θ , ι , λ , μ , ψ , in the annexed diagram.

To find θ and ι , fig. 2, let the observer imagine a straight line drawn from δ to β , to be continued beyond β . The first stars of the same magnitude as δ which it will meet will be θ and ι . Again, let a straight line be imagined to be drawn from δ to γ , and continued beyond γ . It will carry the eye to the star ψ of the same magnitude as δ . Finally, if a line be imagined to be drawn from θ perpendicular, the line passing through the four stars δ , β , θ , and ι , it will conduct the eye to the two stars λ and μ .

If the observer look at any good map of the stars,* he will find that the stars α , β , and γ , are on the body of the figure of the Bear; δ , ϵ , ζ , η , form the tail, θ and ι are on the right fore leg, ψ on the hinder right thigh, and λ and μ on the hinder right paw.

The practical usefulness of the imaginary figures which give names to the constellations will thus be understood. If we desire to express the position of the star η *Ursæ Majoris*, for example, we say that it is at the *tip of the tail* of the Great Bear.

The seven principal stars of this constellation being all less than forty degrees from the north pole, will be always above the horizon in latitudes greater than forty degrees. Hence it is that this constellation is so familiarly known. It is in the quarter of the heavens opposite to that in which the sun is in the month of March, and is therefore visible at midnight near the meridian *above* the pole at that season. In the month of September it is visible at midnight *below* the pole.

The point in the firmament whose position ought to be most familiar to the observer is the pole. Its position is marked by a star of the second magnitude, which is so near to it that the interval can not be appreciated without the use of good astronomical instruments. It is therefore very important that an easy method, applicable without instruments, should be available for the discovery of this star. The method already explained may be used also in this case. In the annexed figure the seven stars of *Ursa Major* are represented in the lower part. The stars of the upper part are those of a constellation near the pole called *Ursa Minor*. The actual position of the pole is represented at \odot , and the star immediately above it is the pole-star.

If a line be conceived to be drawn between the two stars α and β , fig. 3, in *Ursa Major*, and continued beyond α , it will pass very nearly through the pole-star, and as there is no star of the same magnitude near the latter, the eye can not fail to recognize it. The other stars of the constellation of the lesser Bear, are all of inferior brightness. The figures annexed to the several stars in this diagram express their respective magnitudes. The two stars α and β , of *Ursa Major*, have hence been denominated the *POINTERS*. The apparent distance between the pointers is 5° , while the distance from α to the pole-star is 29° . Thus the latter distance is nearly six times the former.

* We should recommend the amateur astronomer to be provided with the maps of the stars published on extremely cheap terms by the London Society for the Diffusion of Useful Knowledge, together with the "Companion to the Maps," by Professor de Morgan. These are always on hand at Mr. Baldwin's bookstore, Broadway, New York.

Fig. 3.

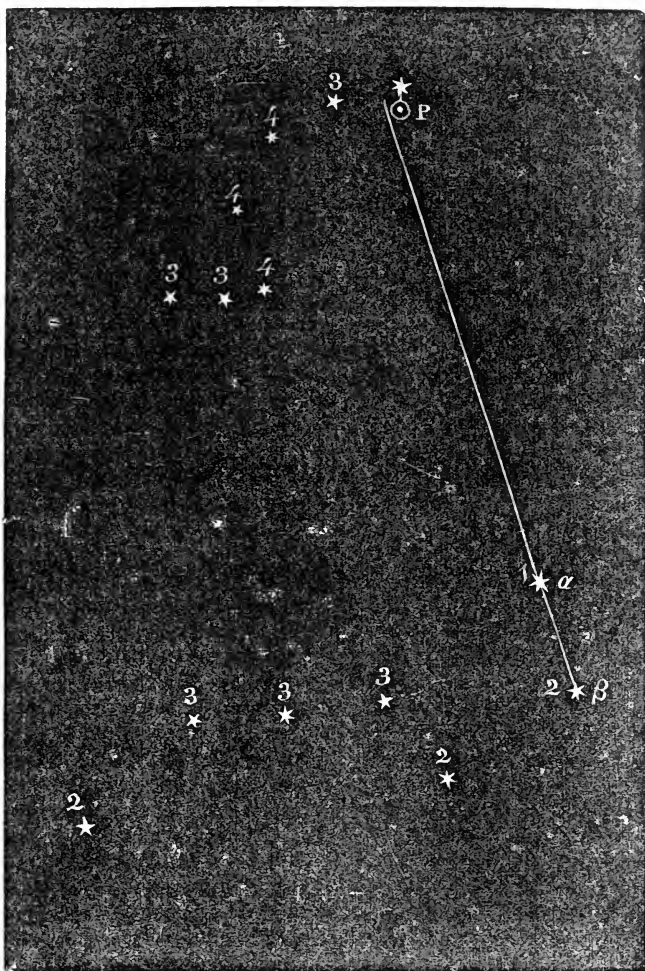

By attentively observing for a few successive hours the changes of position of these objects with relation to the horizon, it will be easily perceived that the line through the pointers and the pole-star revolves round the latter point as a centre, and in three hours it will be observed to revolve through an angle of 45° , which being half a right angle, can be estimated with some degree of approximation by the eye. We may thus see that the firmament appears to revolve round the axis of the sphere at the rate of about 15° per hour.

Another remarkable group of stars visible in northern latitudes at all seasons, is the constellation called *Cassiopeia*, consisting of five principal stars. The configuration of these, which is given in the annexed diagram, fig. 4, is familiar to every eye accustomed to contemplate the heavens. The star β , is of the second, and the remaining four of the third magnitude.

This constellation being in the quarter of the heavens opposite to that in which the sun is in the month of October, will be seen on the meridian, or

Fig. 4.

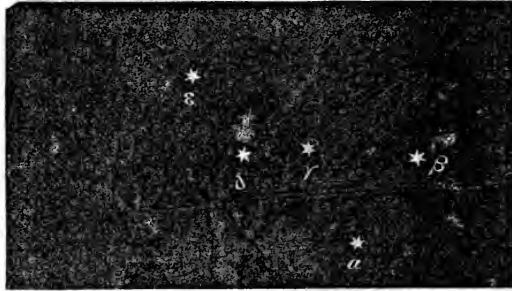

near it, at midnight during that month, and being distant from the pole about 30° , it will be seen a little south of the zenith at all places between the latitudes 40° and 60° .

The two most conspicuous stars which appear in the northern region of the heavens are those called *Capella* and α *Cygni*. They are both stars of the first magnitude. *Capella* is seen in the meridian above the pole at midnight in the early part of January, and α *Cygni* in the early part of August. At New York these stars pass within a few degrees of the zenith, through which they both exactly pass at all places having the latitude of 45° N.

If we turn due south and look to that point of the celestial meridian whose distance from the zenith is equal to the latitude of the place of observation, we shall see the point of the heavens where the celestial equator intersects the meridian. Those parts of the heavens which extend to about thirty degrees above and below this point, and which stretch on either side of the meridian to the eastern and western points of the horizon, form by far the most interesting and remarkable regions of the firmament. Not only is this region more rich in constellations, and adorned by the most brilliant stars, but it is the space within which the range of the planets is confined. By the diurnal motion of the celestial sphere, these constellations, together with such of the planets as happen to be sufficiently removed from the sun and the moon, when that object is not too near the sun, are passed nightly, like a moving diorama before the observer. As he stands facing the south, the east will be on his left, and the west on his right. He will behold the zodiacal constellations successively coming into view from below the horizon, at or near the eastern point; they will gradually rise toward that part of the meridian to which we have referred, and passing it, will descend toward the western part of the horizon, where they will finally disappear.

The most remarkable of these equatorial constellations is that called ORION. The principal stars composing it are those marked α , γ , δ , ϵ , σ , β , κ , ι , in the annexed diagram, fig. 5. By reference to a celestial globe, or still better, to a map of the stars, it will be seen that this constellation is made to form the outline of the figure of a warrior. The star α is on the right shoulder, γ on the left, the stars δ , ϵ , σ , on the belt, ι on the sword, β on the left foot, and κ on the right knee. The stars α and β are both of the first magnitude, and both double stars. The latter (β) is better known by the name of RIGEL. The stars γ , δ , and ϵ , are of the second magnitude, and δ is a double star. The position of the constellation with reference to the meridian will be perceived by the arrow, which indicates the direction of the north.

In the month of December, this constellation passes the meridian about midnight, and is therefore visible on the eastern side of the heavens during the

Fig. 5.

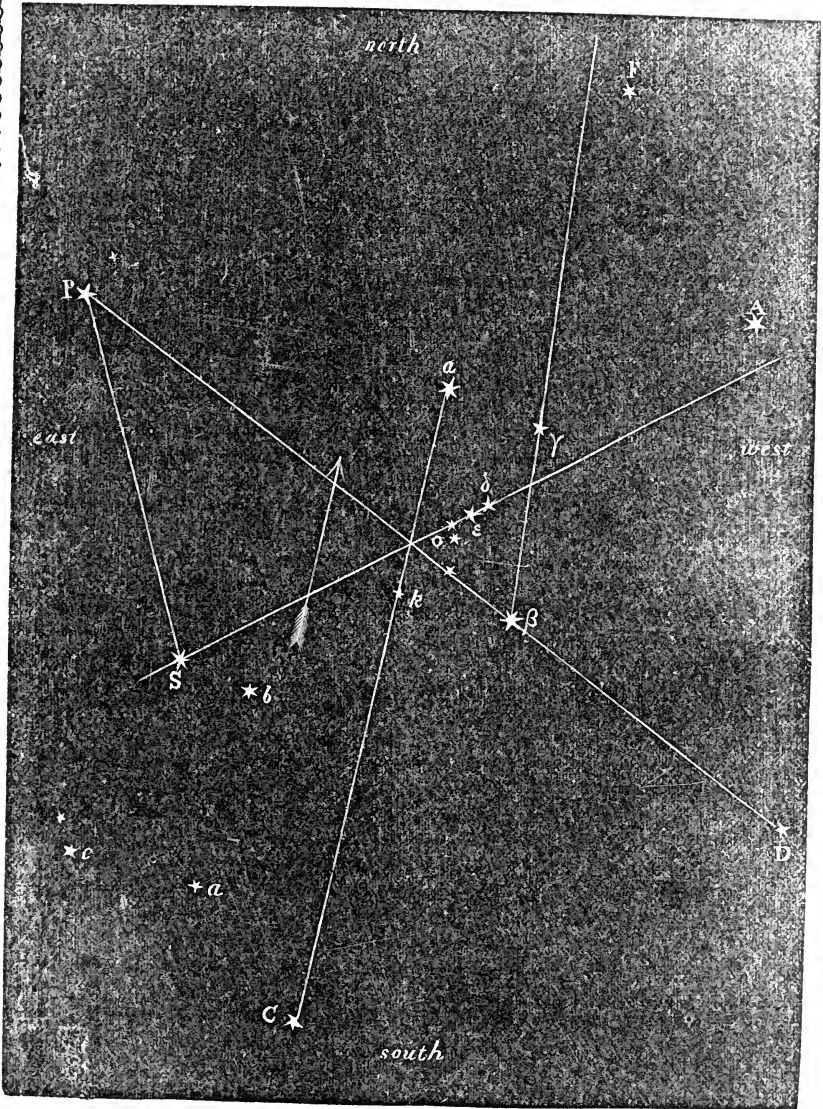

early part of the night. The stars δ , ϵ , σ , which form the belt, being upon the celestial equator, rise each evening at six o'clock precisely at the point of the horizon which is due east, and at nine o'clock the constellation is elevated midway between that point and the meridian.

If a line be imagined to be drawn in the direction of the belt, and continued both ways, east and west, it will pass a little north of the splendid star SIRIUS (S), in the constellation of CANIS MAJOR, commonly called the DOG-STAR, on the east, and a little south of another brilliant star, ALDEBARAN (A), on the west. This latter star forms the eye of the zodiacal constellation TAURUS. Other stars in the constellation of *Canis Major* are represented at *b c d*.

If a line be imagined to be carried from Sirius (S), in a direction perpendicular to that which passes through the belt of Orion, it will conduct the eye to the bright star PROCYON (P), in the constellation of CANIS MINOR, which is a star of the first magnitude, with one of the third magnitude near it.

If a line be conceived to be drawn from Rigel (β), through γ , and carried upward, it will pass a little east of a bright star of the second magnitude (E), in the foot of the constellation AURIGA.

If a line be imagined to be drawn from α through κ , and carried downward, it will pass through another bright star (C), of the second magnitude in the constellation COLUMBA.

The stars SIRIUS (S), PROCYON (P), and ALDEBARAN (A), are all of the first magnitude, and very splendid objects. *Sirius*, however, is not only the most magnificent of these, but is the brightest star in the firmament. This star was frequently submitted to telescopic examination by the late Sir William Herschel, with the extraordinary optical powers which that observer commanded, and he relates that when it approached the field of view of the forty-foot telescope, the effect resembled the approach of sunrise, and when the glorious object entered the field of view the splendor was so overpowering that he was obliged to protect the eye by a colored glass!

Dr. Wollaston calculated that this star must be equal to fourteen suns like that of our system. This calculation, however, was founded on the supposition that the star is much nearer to us than it is now known to be, and the splendor of the object has therefore been greatly *underrated*!

In the constellation of *Orion* are a considerable number of stars under the third magnitude, not represented in the diagram, (p. 357), many of which, when examined by powerful telescopes, prove to be double stars; besides which is found in the sword the most remarkable nebulae in the firmament, which we shall hereafter notice more fully.

If a line drawn from *Procyon* (P), to *Rigel*, and continued westward, it will conduct the eye to the star (second magnitude) D, in the constellation DRACO, known in astronomy as γ *Draconis*. This star is celebrated in astronomy as that by observing which Dr. Bradley discovered the aberration of light.

The midnight sky, in the months of March and April exhibits the zodiacal constellations of LEO and VERGO, the constellation of BOOTES and COMA BERENICES. These constellations contain three of the most splendid stars in the firmament: REGULUS in LEO, SPICA in VERGO, and ARCTURUS in BOOTES.

Regulus is seen at midnight on the meridian, on the 20th February. In March it passes the meridian between nine and eleven, and in April between seven and nine. The point where it crosses the meridian at New York, and other places in the same parallel, is about 30° south of the zenith. At places south of New York it will be nearer to, and north of New York more distant from the zenith.

Spica is seen at midnight on the meridian on the 10th April. In March it passes the meridian between midnight and two in the morning, and in the end

of April and the beginning of May it passes the meridian between midnight and nine o'clock. It crosses the meridian at New York at 50° south of the zenith, and will therefore be seen to more advantage in places further south. At Charleston it passes the meridian 43° , and at New Orleans 40° south of the zenith.

ARCTURUS is upon the meridian at midnight on the 22d April. During the month of May it passes the meridian between nine and eleven at night, and in June between seven and nine. At New York it crosses the meridian 20° south of the zenith, at Charleston 13° , and at New Orleans 10° south of it. In all parts of America this star is therefore seen to great advantage.

In the annexed diagram, fig. 6, the collocation of the principal stars in these three constellations is exhibited. The star ARCTURUS is placed at A, with the principal stars of the constellation BOOTES around it. All except *Arcturus* are stars of the third magnitude, and it is worthy of note that they are all *double stars*.

The star *Spica* is at S; the other chief stars of *Virgo*, γ , η , δ , and V, being of the third magnitude. The star γ is in fact two stars close together, one of which (that to the west) being a double star.

The star *Regulus*, which is a double star, is at R. In the constellation of *Leo* are also two stars, β , and γ , of the second magnitude. These three principal stars form a right-angled triangle, the right angle of which is at γ . This last star, γ , is a double star. The three other chief stars of this constellation, η , θ , and δ , form an isosceles or equal-sided triangle, the base of which is the line joining θ and δ .

It will be also observed that *Regulus*, *Spica*, and *Arcturus*, form a right-angled triangle, the right angle of which is at *Spica*.

In the months of May, June, and July, the heavens, during the night, exhibit the constellations LYRA, AQUILA, HERCULES, OPHIUCHUS, and the zodiacal constellations SCORPIUS, SAGITTARIUS, and CAPRICORNUS. These include but three stars of the first magnitude; the star α , in the constellation of LYRA, ATAIR in AQUILA, and ANTARES in SCORPIUS.

Antares is on the meridian at midnight on the 27th May. During the month of June it passes the meridian between ten o'clock and midnight. This star, however, being about 26° south of the celestial equator, is not seen with advantage in the northern hemisphere. At New York this star passes the meridian at 66° from the zenith, and therefore never rises to a greater altitude than 34° . At New Orleans its meridional altitude is 44° , and it may accordingly at the proper season be seen there more advantageously.

The star α *Lyra* passes nearly through the zenith of New York at midnight on the 29th June, and during the months of July and August may be seen during the night, crossing the meridian between eight o'clock and midnight. It is a splendid star of the first magnitude, and having no other bright star in its neighborhood, is at once recognised. This is a double star. This star passes the meridian in all parts of the United States within less than ten degrees of the zenith.

The star *Atair*, in the constellation *Aquila*, passes the meridian about one hour later than α *Lyra*, and at New York crosses it at the distance of 30° from the zenith. This star has in its immediate neighborhood, forming part of the same constellation, seven stars of the third magnitude.

In the annexed diagram, fig. 7, L represents α LYRA, and A ATAIR. A line joining these two stars of the first magnitude passes through four of the third magnitude, γ *Lyra* and γ , β , and θ *Aquila*. The four stars λ , δ , ζ , and ϵ , are of the third magnitude, and also form part of the constellation *Aquila*. The star *Atair* is a double star.

Fig. 6.

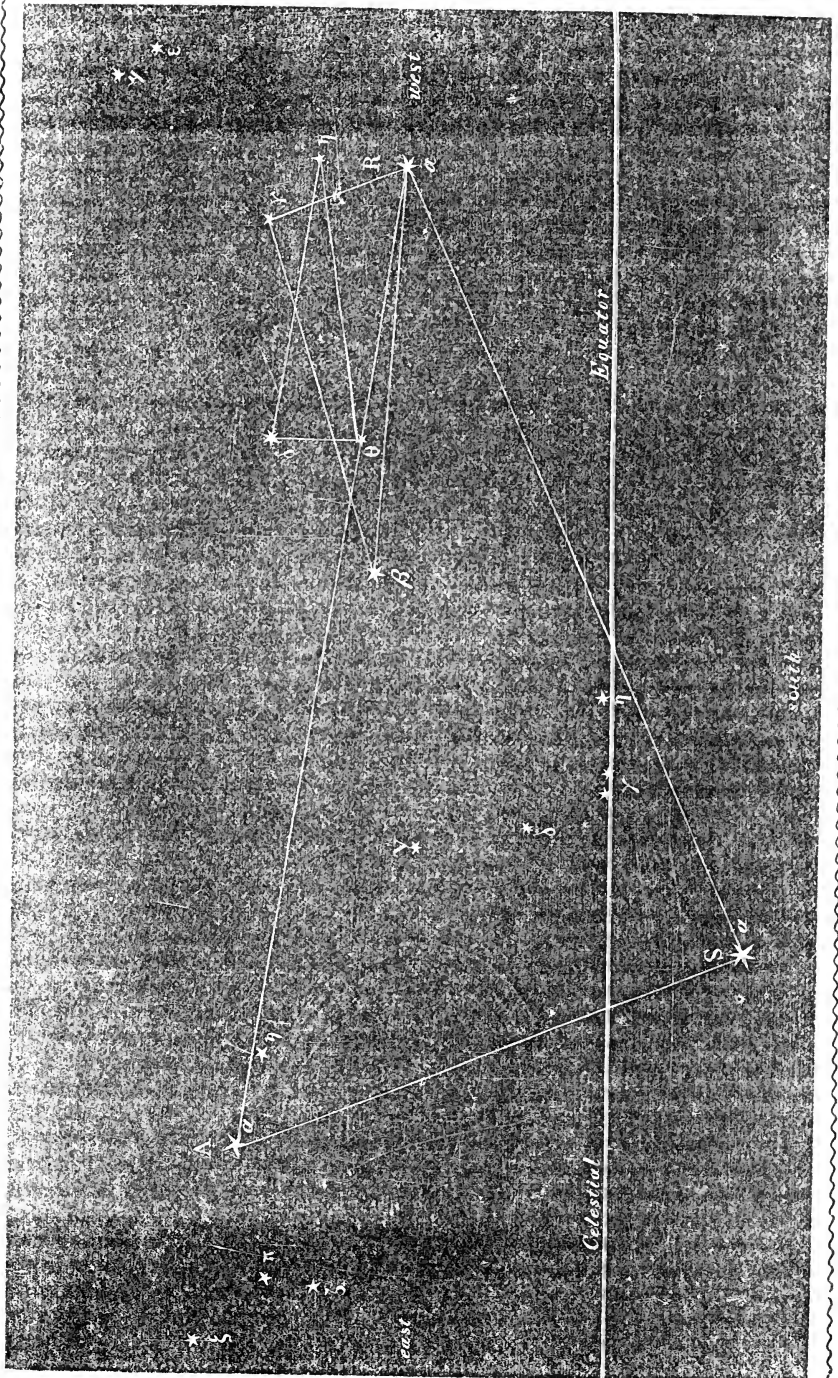
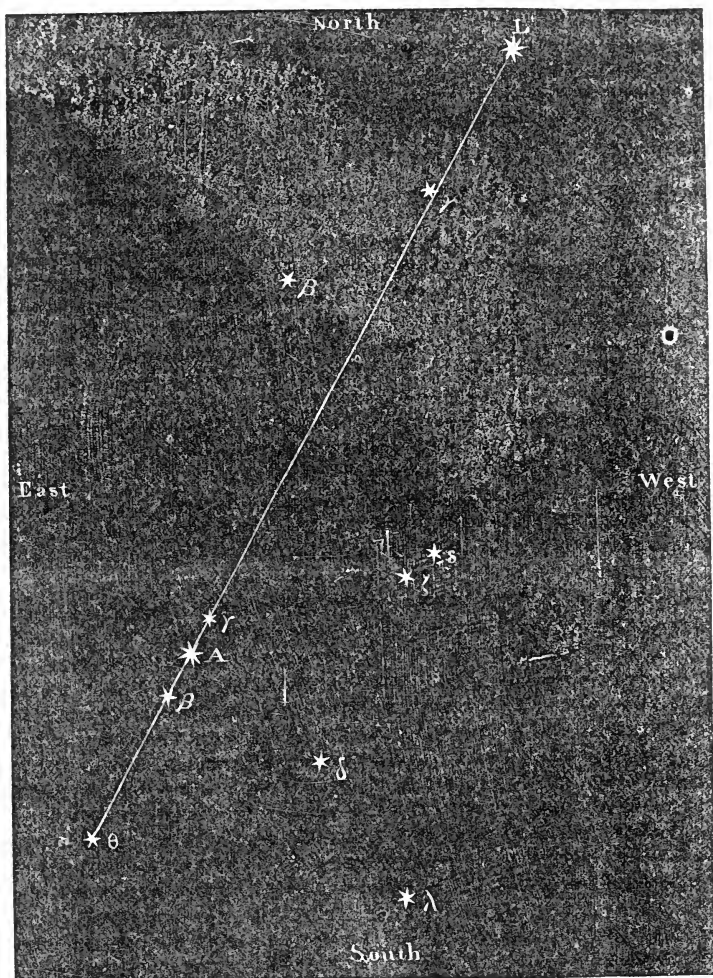

Fig. 7



On the 2d September, the star *Fomalhaut* (first magnitude), passes the meridian at midnight. This star being situate 30° south of the celestial equator, is unfavorably situate for observation in northern latitudes. At New York its greatest altitude is 20° . There are three conspicuous stars of the second magnitude in the constellation of *Pegasus*, two of which, *Markab* and *Scheat*, are on the meridian at the same time with *Fomalhaut*, and the third ϵ , about an hour and a quarter before.

In the annexed diagram, fig. 8, the most conspicuous stars which appears during the night in August, September, and October, are represented. The stars marked 1, are in the constellation *Pegasus*. The stars α 1, β 1, and ϵ 1, are of the second magnitude, the last being a double star. The star ζ 1, is of the third magnitude, as also is the star α 2, which is on the right shoulder of *Aquarius*. The star α 1, and β 1, are also called *MARKAB*, and *SHEAT*. These are on the meridian together, and are separated by about 12° .

The star γ 1, (second magnitude), is on the wing of *Pegasus*, and is on the meridian at the same time with the bright star α 3 (first magnitude), which is on the head of *Andromeda*. These two stars are on the meridian at midnight on the 20th September. The star α 3 passes the meridian at New York about 12° south of the zenith. This is a double star.

The four conspicuous stars α 3, γ 1, α 1, and β 1, are easily recognised on the firmament, the lines which join them forming nearly a square. The star β 3 (second magnitude), is a double star on the girdle of *Andromeda*, and lying very nearly in the direction of the diagonal of the quadrilateral formed by the stars α 3, γ 1, α 1, and β 1. The star δ 3, of the third magnitude, is on the breast of *Andromeda*.

The two stars α 5, and β 5, which form the base of an isosceles-triangle, having its vertex at the star β 3, are in the head of *ARIES*, and are stars of the third magnitude. The star β 5, is double. These stars are on the meridian at midnight on the 20th October.

The α 6 is a conspicuous star of the second magnitude called *MENKAR*, in the constellation of the Whale (*Cetus*), and γ 6, near it, is a double star of the third magnitude, in the same constellation.

The amateur observer may, from the examples which have here been given, easily extend his acquaintance with the fixed stars. In the maps of the stars published by the Society for the Diffusion of Useful Knowledge, already referred to, he will find marked the days on which each star is seen on the meridian at midnight. Its place on the meridian may be found by the following simple rule, in which it is assumed that the place of the observer has north latitude:—

“Observe on the map the distance of the star from the celestial equator. If the star be north of the equator, the difference between this distance and the latitude of the place will give the distance of the star when on the meridian from the zenith. It will be south of the zenith if the latitude of the place be greater than the distance of the star from the equator—north if less. If the latitude of the place be equal to the distance of the star from the equator, the star will pass through the zenith. If the star be south of the celestial equator, add its distance from the equator to the latitude of the place, and the result will be the distance south of the zenith at which the star will pass the meridian.” The following examples will illustrate this rule:—

Example 1.—It is required to determine the point at which the star *Castor* crosses the meridian of New York.

By reference to the maps or a celestial globe, it will appear that the star *Castor* is $57^\circ 45'$ north of the celestial equator. The latitude of New York being assumed to be $40^\circ 43'$ N., we shall

From	-	57°.45'
Subtract	-	40°.43'
		17°. 2'

and the remainder, $17^\circ.2'$, will be the distance north of the zenith at which *Castor* passes the meridian.

Example 2.—To find the point at which *Fomalhaut* passes the meridian of New York.

The distance of *Fomalhaut* south of the celestial equator being taken from the map to be $30^\circ.30'$, we shall

To	-	30°.30'
Add	-	40°.43'
		71°.13'

and the sum $71^\circ.13'$ will be the distance south of the zenith at which *Fomalhaut* passes the meridian.

Fig. 8.

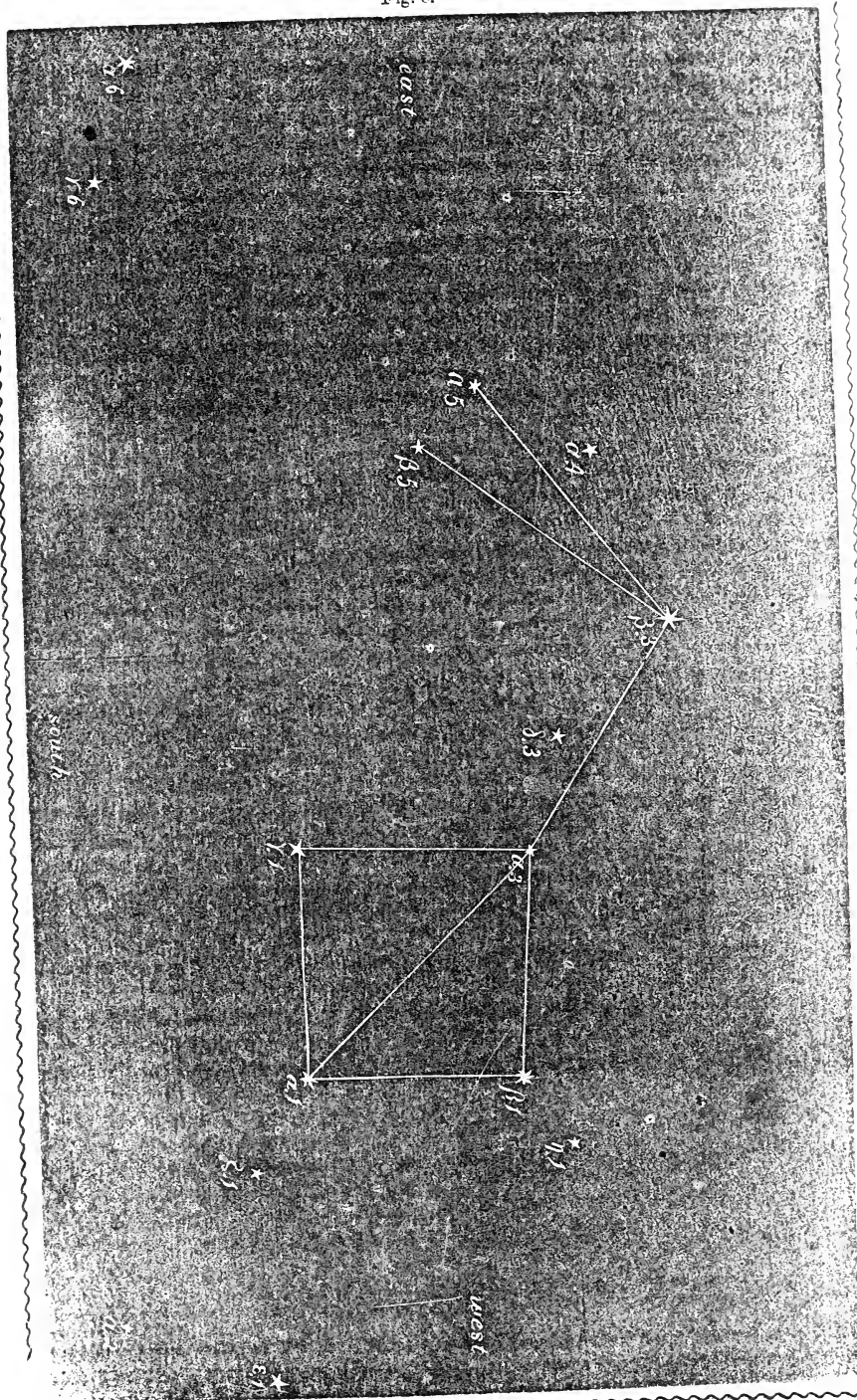

Example 3.—To find the point at which α *Aquila* passes the meridian of New York.

The distance of α *Aquila* north of the celestial equator being taken from the map to be $28^{\circ}.45'$, we shall

$$\begin{array}{r} \text{From} \quad - \quad 40^{\circ}.43' \\ \text{Subtract} \quad - \quad 28^{\circ}.45' \\ \hline 11^{\circ}.58' \end{array}$$

and the remainder, $11^{\circ}.58'$, will be the distance south of the zenith at which the star passes the meridian.*

A celestial globe, where it can be had, will prove a ready and convenient aid to the amateur in astronomy, superseding the necessity of many calculations which are often discouraging and repulsive, however simple and easy they may be to those who are accustomed to such inquiries. Most of the almanacs contain tables of the principal astronomical phenomena, of the places of the sun and moon, and of the principal planets as well as the times when the most conspicuous stars are on the meridian of Washington after sunset. These data, together with a judicious use of the globe and a tolerable telescope, will enable any person to extend his acquaintance with astronomy, and may even enable him to become a useful contributor to the common stock of information which is now so fast increasing by the zeal and ability of private observers in so many quarters of the globe.

To prepare the globe for use, let small marks (bits of paper gummed on will answer the purpose) be placed upon it, to indicate the positions of the sun, moon, and planets, at the time of observing the heavens. The place of the sun on the ecliptic is usually marked on the globe itself. If not, its right ascension (that is, its distance from the vernal equinoctial point, measured on the celestial equator), and its declination (that is, its distance north or south of the equator), are given in the almanac for every day. The moon's right ascension and declination are likewise given.†

To find the place of an object on the globe when its right ascension and declination are known.

Find the point on the equator where the given right ascension is marked. Turn the globe on its axis till this point be brought under the meridian. Then count off an arc of the meridian (north or south of the equator, according as the declination is given), of a length equal to the given declination, and the point of the globe immediately under the point of the meridian thus found, will be the place of the object. By this rule, the position on the globe of any object of which the right ascension and declination are known, may be immediately found, and a corresponding mark put upon it.

To adjust the globe so as to use it as a guide to the position of objects on the heavens, and as a means of identifying the stars and learning their names, let the lower clamping-screw of the meridian be loosened, and let the north pole of the globe be elevated by moving the brass meridian until the arc of this meridian between the pole and the horizon be equal to the latitude of the place of observation. Let the clamping-screw be then tightened so as to maintain the meridian in this position. Let the globe be then so placed that the brass meridian shall be directed due north and south, the pole being turned to the north. This being done, the globe will correspond with the heavens so far as relates to the poles, the meridian, and the points of the horizon.

* In these examples I have taken the declinations roughly from the map rather than from the tables, as that would be the method which an amateur would probably use.

† In the UNITED STATES ALMANAC a sufficient collection of tables and astronomical data for all the purposes of the amateur astronomer are given. It will be necessary that he should first render himself familiar with the abbreviations and symbols, after which he will find the greatest advantage from that work.

To ascertain the aspect of the firmament at any hour of the night, it is now only necessary to turn the globe upon its axis until the mark indicating the place of the sun shall be under the horizon in the same position as the sun itself actually is at the hour in question. To effect this, let the globe be turned until the mark indicating the position of the sun is brought under the meridian. Observe the hour marked on the point of the equator which is then under the meridian. Add to this hour the hour at which the observation is about to be taken, and turn the globe until the point of the equator on which is marked the hour resulting from this addition is brought under the meridian. The position of the globe will then correspond with that of the firmament. Every object on the one will correspond in its position with its representative mark or symbol on the other. If we imagine a line drawn from the centre of the globe through the mark upon its surface indicating any star, such a line if continued outside the surface toward the heavens would be directed to the star itself.

For example, suppose that when the mark of the sun is brought under the meridian, the hour 5h. 40m. is found to be on the equator at the meridian, and it is required to find the aspect of the heavens at half past ten o'clock in the evening.

	H.	M.
To	-	5 40
Add	-	10 60
		16 00

Let the globe be turned until 16h. 0m. is brought under the meridian, and the aspect given by it will be that of the heavens.

We have frequently spoken of stars of the first, second, and inferior magnitudes. It is necessary that the just application of this term magnitude be clearly understood. The Creator of the universe has not made the visible stars in six moulds, so as to give them as many exact and distinguishable magnitudes. Among these objects there is every gradation of brightness from the splendor of Sirius down to that of those stars which are barely perceptible without a telescope. Between those stars which astronomers have consigned to the first and second classes, respectively, there is no distinct and decisive line of separation. The stars of the first magnitude are not equally bright; nay, it is probable that no two of them could be selected, which, if submitted to photometric tests, would prove to be of exactly equal splendor. The least splendid of them is not distinguishable from the most splendid of the stars of the second magnitude, and in general it may be said that the least bright stars of any magnitude are not distinguishable from the largest and brightest of the class next below them. The classification of stars into magnitudes is therefore arbitrary, and not founded on any distinction really existing in nature. Still, when properly understood, the classification of stars by magnitudes is not without considerable utility as means of record and of reference, and it is accordingly adopted by astronomers of every country.

The term magnitude, however, is applied to stars in a very different sense from that in which it is used as applied to planets. The latter present, when seen in a telescope, a perfectly-defined disk, the diameter of which is capable of pretty exact measurement. Before the invention of the telescope, stars were supposed also to have sensible magnitudes, and it was an unanswerable argument against the probability of the Copernican system that, admitting (which was necessarily supposed), that the fixed stars must be so distant that the entire orbit of the earth seen from them would seem but a point, their apparent magnitude rendered it necessary to admit that the largest of them at least must be many times larger than a globe which would fill the orbit of

the earth, that is, than a globe whose bulk would be above ten million times greater than that of the sun. The telescope showed, however, that the appearance of magnitude was altogether illusory and dependent on atmospheric phenomena; for, though upon hazy or troubled nights stars may appear large, their magnitude is not permanent, but accompanied with a boiling, tremulous, or bubbling outline. And in good climates and still nights no micrometer will give a sensible outline or apparent diameter to any but large stars. That such, when viewed through large and powerful telescopes, may exhibit some slight sensible magnitude, may be true, but it is demonstrable by the admitted principles of optics, that even a lucid point, if such could exist, could never appear as a *mere point* through any telescope constructed with spherical refracting or reflecting surfaces. The term magnitude, therefore, must be understood as expressing merely apparent brightness, which, not being capable of being exactly measured as to degree, must have an indefinite application.*

The stars which have been placed in the first class of magnitude amount to about twenty in number, and these differ from each other considerably in apparent splendor. Let any one look at the Dog-star, and then immediately turn his eye to α *Ursæ Majoris*, or to α *Orionis*, and he will be immediately conscious of this. If the brightness of the latter be expressed by 100, Sir John Herschel estimates that of the Dog-star at 324.

If the brightness of a star of the sixth magnitude (the smallest distinctly visible to ordinary eyes without a telescope), be supposed to be expressed by 1, the brightness of those of superior magnitudes will, according to Sir William Herschel, be expressed as follows:—

Brightness of a star of the average 6th magnitude.....	1
Ditto ditto 5th.....	2
Ditto ditto 4th.....	6
Ditto ditto 3d.....	12 (?)
Ditto ditto 2d.....	25
Ditto ditto 1st.....	100

Of these estimates, that astronomer considered the third as doubtful, the others more exact.

We have already observed that the telescope augments our range of vision by rendering perceptible stars which are lost to the eye by reason of their distance. It also multiplies the objects visible to us, even in the radius which circumscribes stars of the sixth magnitude. It may however be asked, how it is that the telescope can effect this, seeing that it is incapable of presenting any star, even the largest, to the eye, as anything but a lucid point, without definite outline or appreciable magnitude. Let us therefore explain this.

In the front of the eyeball is a colored annular membrane called the iris, in the centre of which appears a circular black spot. This spot is not a black substance, but is an aperture which seems black only because the chamber within it is dark. This aperture is the window of the eye provided for the admission of light. On the inside of the eye, lining the inner surface opposite this window, is the membrane called the retina, endowed with a specific sensibility, in virtue of which, when light strikes upon it, an effect is conveyed by the nerves therewith connected to the seat of sensation, by which vision is effected.

The sensibility of the retina is limited. Light may act on it so slightly as to produce no perception. To produce vision, therefore, it is not enough that light be admitted through the pupil; it must enter in *sufficient quantity*. Let us then suppose the eye directed toward a luminous object such as a star.

* See De Morgan on the Maps of the Stars, p. 79.

The quantity of light which will enter the eye will depend conjointly on the magnitude of the pupil and the *density* of the light. If sufficient light to produce vision do not enter the pupil, there are two and only two ways to make it sufficient. We must either enlarge the pupil, or augment the density of the light so as to send in through the unenlarged aperture an increased quantity.

Since the density of the light which diverges from a visible object diminishes in a very high proportion as the distance from the object is increased, we can increase the density, and thereby render an invisible object visible by diminishing our distance from it; that is, by approaching nearer to it. This expedient every one is familiar with, but it is an expedient not practicable by a creature whose movements are limited to the surface of the earth.

Since we can not then approach the object, we must see whether we may not enlarge the window by which light is admitted to the pupil. Thus the telescope has happily accomplished. In fig. 9, a star is represented with a diverging cone of light proceeding from it toward the eye. The number of

Fig. 9.

Fig. 10.

Fig. 11.

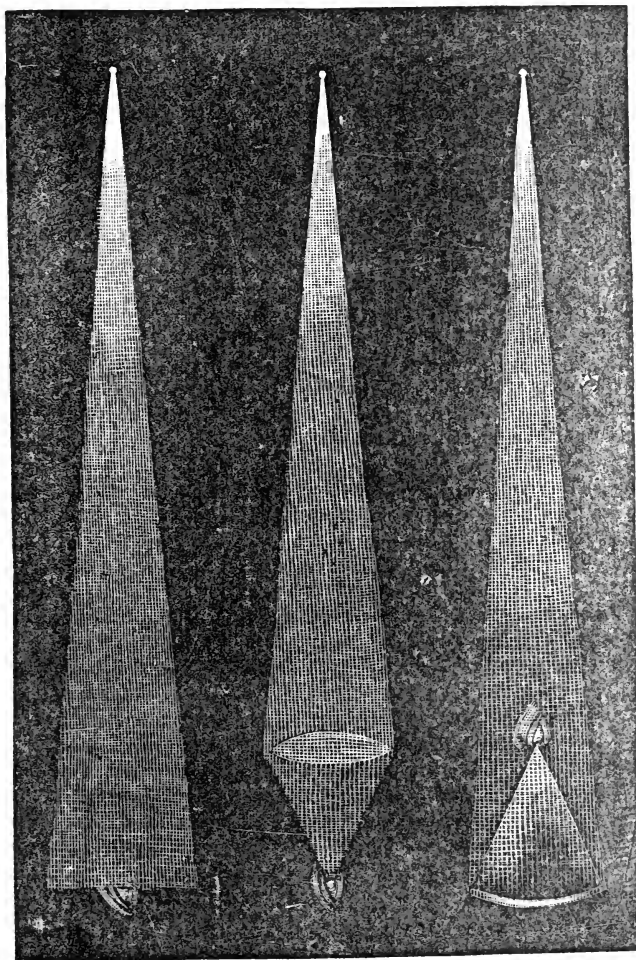

these diverging rays which will enter the eye is limited by the magnitude of the pupil. But before they reach the eye they may be received upon a glass lens of a convex form (fig. 10), which will have the effect of collecting them into a space less in magnitude than the pupil of the eye. If the eye be placed where the rays are thus collected, all the light transmitted by the lens will enter the pupil.

Now let us see what will thus be effected. The object-lenses of some telescopes are above ten inches diameter. Most common telescopes, however, are much smaller. Suppose, for example, the lens has five inches diameter, and taking the diameter of the pupil at a quarter of an inch, the ratio of these diameters would be 20 to 1, and consequently the superficies of the lens would be four hundred times greater than the opening of the pupil, and would therefore admit four hundred times more light. A lens of ten inches diameter, having a surface four times greater than one of five inches, would therefore admit sixteen hundred times more light than the pupil.

What is effected by a convex lens, as represented in fig. 10, may also be accomplished by a concave reflector, as represented in fig. 11. In the one case the light is *transmitted through* the surface which receives it—in the other it is *reflected from* it. In the one case the eye which receives the light is placed *behind* the lens and directed *toward* the object—in the other it is placed *before* the reflector, and looking in a direction opposite to that of the object. The observer turns his face to the object in the one case, his back in the other.

But in the practical realization of this, there are two circumstances to be taken into account. *First*—There is no body which is capable of perfectly transmitting or reflecting light; that is to say, there is none which will either transmit or reflect *all* the light which strikes upon it. Light is then lost in a greater or less proportion whenever refraction or reflection takes place. If this loss of light were in the same proportion as that of the magnitude of the lens or reflector to that of the pupil, then nothing would be gained by the optical expedient above explained. But such is not the case. Although a certain proportion of the rays incident on a lens fail to pass through it, and a much greater proportion of those incident on a reflector fail to be regularly reflected from it, yet even the highest of these proportions of loss is incomparably less than the proportion in which the light is condensed.

Secondly—The eye in general has been so constituted by its Maker, as to be capable of producing distinct vision only when the rays which enter the pupil from any point of a visible object, are parallel, or nearly so. Now, when the rays are collected by either of the expedients above explained, they will first *converge* to a focus, and afterward diverge from it. If the eye be placed within the focus, it will receive converging rays, if without it, diverging rays; and in either case vision would be indistinct. This difficulty is surmounted by placing between the eye and the rays collected into a focus a small lens, which may be either convex or concave, and which is so adapted that it will render the rays parallel, without affecting them in any other way.

Such is the combination which forms an astronomical telescope.

By an instrument of this kind, then, we accomplish what is equivalent to an enlargement of the pupil, and objects which transmit light so attenuated as to be incapable of affecting the retina with sufficient energy to produce vision, may by such means be rendered visible. If, for example, the quantity of light received by the pupil from any distant star be ten times less than that which would be necessary to produce vision, such a star will become visible in a telescope whose object-glass is capable of condensing the light so as to render it ten times more intense.

From what has been explained, it will be apparent that the telescope, while it is incapable of exhibiting to us even the nearest of the stars with any sensible magnitude, may however be applied with success to obtain an approximate estimate of the relative distances of those stars which, by reason of their remoteness, are invisible without its aid. By applying proper principles of calculation, it is easy to determine the magnitude of the telescope which will double or treble, or, in short, which will augment the range of the natural eye in any required proportion. Thus, if we assume that the smallest star visible to the naked eye, is at a distance over which light would take ten years to pass, we can find the magnitude of the lenses or reflectors which would enable us barely to perceive similar stars at the distance which light would take twenty years to move over; and then, by constantly enlarging the opening of the instrument, or what is the same, by using successively telescopes of increased powers, we may bring into view objects whose distances (supposing their real magnitude and brightness to be the same in the main), are greater and greater in known or calculable proportions.

Sir William Herschel actually practised this method of *sounding* the heavens. He classed the stars visible to the naked eye in twelve orders of distance, those of the twelfth order (or smallest), being twelve times more distant than those of the first order. A telescope which would just render visible a star twice as distant as one of the twelfth order, and which therefore would double the range of the eye, he denominated as a telescope of the *second* degree of *space-penetrating* power. One which would bring into view stars three times more distant than those of the twelfth order, he called a telescope of the third power, and so on. Calculating in this way, he found that his great forty-feet telescope had a space-penetrating power of 192. To reduce this power to a still more definite expression, let us call the distance of the brightest and nearest stars 1; that of the smallest stars visible to the naked eye will then be 12; and that of the smallest stars which could be distinctly seen with the forty-feet telescope would be 192 times 12, or 2,304. If the distance of the nearest star be such as light would take ten years to move over, the distance of the smallest stars visible with this instrument would then be such as light would take 23,040 years to move over! The mind is overwhelmed by the contemplation of such spaces.

The results of the application of these wonderful instruments of stellar research in the hands of Sir William Herschel, will be stated on another occasion. Meanwhile, every private observer, supplied with a moderately-good astronomical telescope may, following the example thus placed before him, render his labors profitable to science, by contributing to the multiplication of those facts on the comparison and classification of which the extension of our knowledge of the universe must depend.

Among the objects to which the amateur can direct his attention with most advantage, may be mentioned the observation of periodical and double stars. Although there is no certain or accurate means of estimating the brightness of stars, still, even such approximation as an attentive observer can supply respecting the changes of variable stars, is not without its value. A circumstance incidental to the astronomical telescope has supplied a method of determining the relative quantity of light transmitted by different stars, which is somewhat more accurate than naked estimation. The instrument used for measuring small angular distances is, as we have explained on another occasion, a system of fine wires or threads, which are fixed or moveable, according to the observations to be made, and which are placed in or near the focus of the object-glass where the image of the star is formed. The eye-glass is in fact a microscope, by which this image is magnified, and by which, therefore, the threads or wires

are also magnified, which latter circumstance is a serious inconvenience, but one which has been partially surmounted by using threads of extreme tenuity. If no special means were provided in the telescope, these threads would not be visible at night, for the light of a star would be insufficient to illuminate them. To remedy this, there is an orifice near the middle of the tube, close to which a lamp is placed, the light of which is reflected on the wires and produces a general illumination of the field of view. This orifice can be expanded or contracted to any desired extent, and may even be altogether closed, so that the illumination of the field may be varied at the discretion of the observer. Now when two stars are of such a degree of brightness that an opening may be given to the orifice which will produce such an illumination of the field as will extinguish them, we may compare their brightness by comparing those degrees of light, exposed to which they become invisible. This is still, however, but an approximation. It is not only difficult to get a lamp which will always yield light of the same intensity, and to know whether any given lamp be such or not, but as various stars are of various colors and tints of color, the same lamp will extinguish a star of its own color with an opening of the orifice by which it will not extinguish an equally bright star of a different color. Thus a red light would extinguish a star of the same red tint, while a bluish star, even of inferior lustre, would continue to be visible when exposed to it. It is however by no means impossible that a diligent and judicious employment of lights of different colors might be made to add to our knowledge of this part of astronomy; and it is more especially in such fields that the private observer may become a useful assistant to the public one. Let us consider more fully, then, one or two more of the various ways in which a person fond of looking at the heavens, provided only with a moderately-good telescope and micrometer may make himself useful even without mathematical knowledge.

First, then, with regard to the variation of the fixed stars in magnitude and color. It is evident that the question whether a fixed star revolve on an axis or not, as our sun does, can never be settled except by some variations of appearance presented by its different parts as they come one after another under the eye of the observer, and also that a regular succession of repeated appearances in a star, is a very strong presumption of a rotation round an axis. For instance, the star β Persei will at eight o'clock on Monday evening appear as a star of the second magnitude. On Tuesday, at midnight, it will be decidedly smaller, and on Wednesday night it will resume its original magnitude. If it be watched again on the nights of Thursday, Friday, and Saturday, the same succession of changes will be observed. By repeated observations of this kind properly compared together, it has been calculated that the exact period of this succession of changes in β Persei is two days, twenty hours, and forty-eight minutes.

It will probably be asked how such accuracy can be attained when the changes observed are so gradual that it is evidently impossible to determine even the five minutes when the star resumes the same degree of apparent lustre? As the answer to this very pertinent and natural question involves a point of universal importance in almost every class of astronomical observations, we shall explain it pretty fully.

In all cases of natural phenomena submitted to experimental inquiry, or to observation, rough approximations are first made, and these imperfect estimates afterward become the means of obtaining others of greater accuracy, and so on until the highest degree of precision has been attained. As an example of the application and use of this principle, let us suppose that the length of the year is to be determined, that is, the exact interval of time which elapses be-

tween two successive returns of the centre of the sun's disk to the summer solstitial point. A single observation, however accurate it be, will only give a rough estimate of this, such a one, for example, as will be liable to an error, say of ten minutes of time, five minutes of the error being ascribed to each of the two observations. Instead of observing two successive solstices, let us now observe two solstices having an interval of ten years between them. It might be objected that to do this we must be supposed to know the length of the year, which is the thing we are in quest of. But to this it is answered, that we only require to be sure that the interval between the two solstices which we observe is not either a greater or a less number of years than ten. Now although we do not yet know the exact length of the year, yet we do know that it is certainly greater than an eleventh of the interval between the phenomena we observe, and consequently that the interval can not be so much as eleven years, and that it is less than a ninth, and that therefore it must be more than nine years. But since, from the nature of the phenomena observed, we are sure that there must be a whole number of years intervening (subject only to ten minutes error, five minutes at each observation), we know that this number must be ten. We then take the entire interval of time between the two observed solstices, and we divide it by ten. The quotient will give the length of the year, subject to an error of a tenth part of ten minutes, that is, subject to an error only of one minute. By this expedient, in fact, the sum of the errors of the two solstitial observations is divided among ten years, and the quantity which falls on a single year is only the tenth part of the whole error.

This process may be carried further. The error being thus reduced to a single minute, may again be spread over a still greater interval until the length of the years be obtained, even in fractions of a second of time.

The same method is applicable to all periodical phenomena and among others, to the periodical variations of the stars. By the first rough observation of a single period, we are enabled with certainty to recognise the number of complete periods which intervene between two similar phases of the star observed with a known interval of time between them. We divide that interval by the number of periods, and thereby obtain a second approximation, which enables us to say with certainty how many complete periods there are between two similar phases separated by a much longer interval than the former one. Dividing this as before by the number of periods, we obtain a still closer approximation, and so on.

The double stars, which will be fully noticed on another occasion, supply a fruitful and interesting field of employment for the amateur. Nor need he be discouraged from devoting himself to this labor by the consciousness of his inability to submit his raw observations to those processes of calculation called *reductions*, which are indispensable to render them ultimately available for the high purposes of science. He will not find his labors neglected or contemned. Others, with better means and opportunities, will take the materials and data which he supplies, and apply all those calculations to them which are requisite to render them valuable. Nor will he lose a particle of the credit justly due to him; for to omit the record of the name of the observer, the nature of the instrument, and the place where the original record of the observations is to be found, would be to insure the rejection of the results of such observations both abroad and at home. The fundamental observations of double stars are peculiarly pointed out as the most certain field for the private observer, because they do not require any astronomical clock. The day of the observation is all that is necessary to be known, and accordingly a timepiece, with its necessary accompaniment, a transit instrument, is not

wanted. A telescope of sufficient power to separate the two stars, and a wire micrometer, are the necessary apparatus: of the principle of the latter we shall give a general description, not entering into any of the niceties of its construction, and supposing throughout that the instrument is perfect.*

The wire micrometer is an apparatus to be annexed to a telescope, such that when inserted in the tube the field presents the usual appearance of a luminous circle cut by four very fine wires parallel two and two, the first pair being at right angles to the second.

Fig. 12.

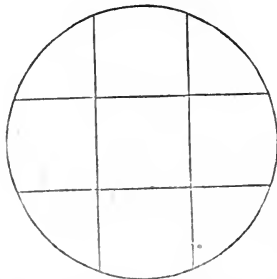

It is found that the apparatus can be turned round so as to give any desired direction to the wires. One pair of wires is placed at a fixed distance from each other. Of the other pair, one is moveable, so as alternately to approach to or recede from that to which it is parallel, preserving, however, its parallelism, during the motion. In fact, the interval between one of the pairs of parallel wires can be increased and diminished at pleasure. This motion is given by a screw which has a small circular head, the edge of which is divided into a certain number of divisions, say 100. The threads of this micrometer-screw are so small that a whole revolution of the graduated carries the moveable wire toward or from that to which it is parallel, through a very small space, and if there be one hundred divisions on the circumference of the head which are sufficiently distinct to be read to a quarter of a division, we can ascertain a motion of the wire which corresponds to the four hundredth part of the effect of one entire revolution. If we desire to measure the interval between two stars which are near each other, as is always the case with the individuals of a double star, we have now only to adjust the instrument until one of the two stars moves (by the diurnal motion of the heavens along the fixed wire), and then by turning the screw adjust the moveable wire, so that the other star shall move along it. It is then only necessary to ascertain how many revolutions and parts of a revolution of the screw are necessary to bring the moveable wire to coincidence with the fixed wire. The distance between the stars will then be known, provided we have previously ascertained what space of the field of view corresponds to one revolution of the screw.

It might perhaps be imagined, that in the original construction of the micrometric apparatus, the screw would be cut so that each revolution might correspond to a certain space, such as one second. Mechanical art, however, has not, and probably never will attain to the degree of perfection necessary to accomplish this. It is very possible to cut a fine screw with threads which in a practical sense may be said to be equal to each other, but he can not do this and *also* insure a result which will make a certain number of these

* De Morgan, pp. 81-2, pp. 84-5, pp. 94-5

threads exactly equal to an inch. In short, he can ensure equality and fineness, but can not confer upon the threads particular, definite, and exact dimensions. Nor is it necessary that this object should be attained, even were it practicable. The observer being furnished with the instrument, each division of which means *something*, can find out from the heavens what that *something* is.

This is very easily accomplished. Supposing the observer to be provided with a clock or watch which beats seconds (the extreme accuracy of a chronometer is not here required), let him direct the telescope as nearly as he can to that point of the southern meridian where the equator intersects it. Very extreme accuracy is not required in this adjustment. Let him then place the fixed and moveable wire in a vertical position, and bringing them to coincidence, let him separate them by giving ten complete revolutions to the screw. Let him then watch the moment when any particular star is seen on the first wire. This he can determine (by listening to the ticking of the clock), to nearly half a second. Let him then wait until, by the diurnal motion of the heavens, the star comes upon the second wire, and observe the time it arrives there. He will then know the time the star took to pass from one wire to the other. But since the firmament makes a complete revolution (360°) in twenty-four hours, it moves at the rate of 15° per hour, or $15''$ per second of time. Let us then suppose that the time which the star took to pass from the one wire to the other was $22\frac{1}{2}$ seconds. The space corresponding to this would be $22.5 \times 15 = 337''.5$; which would therefore be the space between the wires corresponding to the revolutions of the screw. The space corresponding to one revolution would then be $33''.75$, and the space corresponding to one division of the head of the screw would be $0.33''$, or one third part of the second of a degree.

If the observer be not provided with a clock, or can not conveniently use one, if he has it, he may still accomplish the object. Let him in that case direct the instrument to the sun at or near noon, and let him adjust the moveable and fixed wires so that they shall just touch the upper and lower limb of the sun, the position of the wires being horizontal. The space between the wires will then correspond to the apparent diameter of the sun. By reference to the nautical almanac (with which he ought always to be provided), he can ascertain the apparent diameter of the sun at the time of his observation. Suppose that this is found to be $31', 56''$, or $1916''$. Then the interval between the wires will be $1916''$. Let the screw be turned until the moveable wire coincides with the fixed wire, and suppose the number of turns and parts of a turn necessary to effect this is found to be 60 complete revolutions and 12 divisions, or 6,012 divisions; then 1,916 divided by 6,012 gives $0''.3186$ as the value of each division, or $31''.86$ of each complete revolution.

We shall now conclude. Enough has probably been said to encourage the amateur observer, and to set him on the track, by the pursuit of which he may obtain much personal gratification, some reputation in the community of science and render himself useful in the promotion of knowledge. If he begin he will not rest content with these hints, but will call to his aid other more ample and detailed instructions, to be found in the works already referred to, and in the memoirs published by the different scientific bodies of Europe.

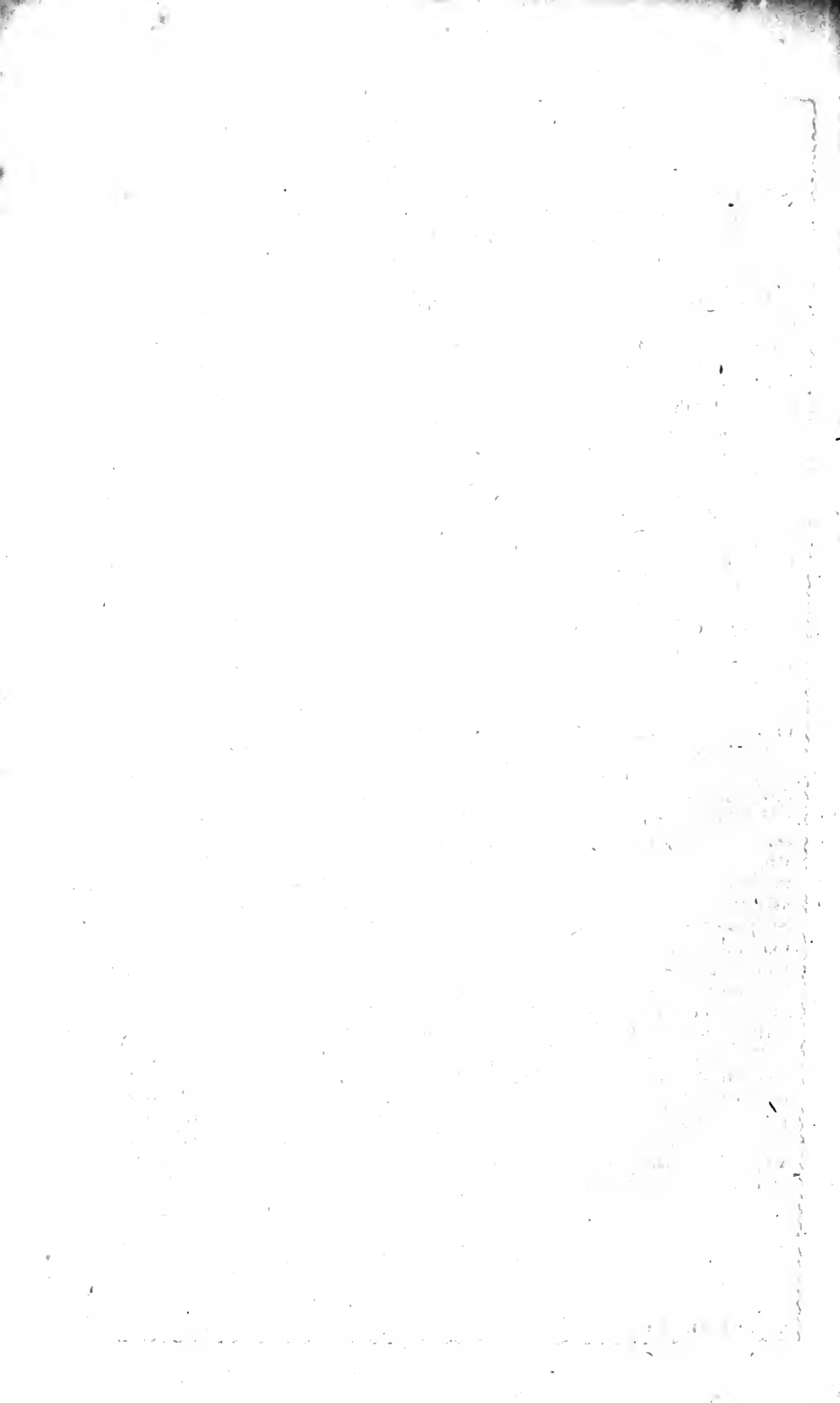

THE STELLAR UNIVERSE.

FIRST LECTURE.

Range of Vision.—Augmented by the Telescope.—*Periodic Stars*.—Examples of this Class.—Various Hypotheses to explain these Appearances.—Their Insufficiency.—*Temporary Stars*.—Remarkable Examples of this Class.—These may possibly be periodic Stars.—*Double Stars*.—Their vast Number.—They are physically connected.—Telescopic Views of them.—How they may indicate the annual Parallax.—Researches of Sir W. Herschel.—Discovery of the orbital Motions of double Stars.—Binary Stars.—Extension of Gravitation to the Stars.—Their elliptic Orbits discovered.—Effects of double and coloured Suns.—*Proper Motions of the Stars*.—Probable Motion of the Solar System.—Analysis of its Effects.—Suggestion of Mr. Pond.—Independent Motions of the Stars.—Proper Motions of double Stars.—Probable Amount of the real Motions of the Stars.

T B T

1870
1871
1872
1873
1874
1875
1876
1877
1878
1879
1880

THE STELLAR UNIVERSE.

(FIRST LECTURE.)

THE distances, probable magnitudes, splendor, and physical character of such of the fixed stars as are visible without telescopic aid, have been already explained.* The range of this survey was shown to be circumscribed by a sphere, of which the solar system is the centre, and of which the radius is a length which light, moving at the rate of two hundred thousand miles per second, would take ten years to traverse. Such is the limit which has been imposed on the natural power of the eye. Beyond this distance the creation was concealed from human vision until the invention and improvement of the telescope. That instrument has augmented the range of observation and discovery in a very high proportion, and has opened to our examination realms of space occupied by innumerable systems, stretching to distances which may be pronounced to be infinite, in the only sense in which that negative term can properly be used.

But besides bringing within the range of the senses objects placed *beyond* the limits of that vast sphere, the telescope has also greatly multiplied the number of visible objects *within* it, by enabling us to see those whose minuteness would have otherwise rendered them invisible. Among those stars which are visible to the naked eye, there are many thousands respecting which the telescope has detected circumstances of the highest physical interest, by which they have become more closely allied with our own system, and by which it is demonstrated that the same material laws which coerce the planets, and give stability, uniformity, and harmony, to their motions, are also in operation in those remote regions of the universe. We shall first notice some of the most remarkable discoveries respecting individuals among the visible stars and shall afterward explain those which relate to the arrangement of the collective mass of stars which compose the visible firmament, and the result of those researches which the telescope has enabled astronomers to make in more remote regions of the universe.

* See discourse on "The Visible Stars," Vol. I., p. 583.

PERIODIC STARS.

The stars in general, as they are stationary in their apparent positions, are equally invariable in their apparent magnitudes and brightness. To this, however, there are several remarkable exceptions. Stars have been observed, sufficiently numerous to be regarded as a distinct class, which exhibit periodical changes of appearance. Some undergo gradual and alternate increase and diminution of magnitude, varying between determinate limits, and presenting these variations in equal intervals of time. Some are observed to attain a certain maximum magnitude, from which they gradually and regularly decline until they altogether disappear. After remaining for a certain time invisible, they reappear and gradually increase till they attain their maximum splendor, and this succession of changes is regularly and periodically repeated.

Such objects have been denominated *periodic stars*. The most remarkable of this class is the star called *Omikron*, in the neck of the Whale, which was first observed by David Fabricius, on the 13th August, 1596. This star retains its greatest brightness for about fourteen days; being then equal to a large star of the second magnitude. It then decreases continually for three months until it becomes invisible. It remains invisible for five months, when it again reappears, and increases gradually for three months until it recovers its maximum splendor. This is the general succession of its phases. Its entire period is about 334 days. This period is always the same, but the gradations of brightness through which it passes are said to be subject to variation. Hevelius states that in the interval between 1672 and 1676 it did not appear at all.

The star called *Algol*, in the head of *Medusa*, in the constellation of *Perseus*, affords a striking example of the rapidity with which these periodical changes sometimes succeed each other. This star generally appears as one of the second magnitude; but an interval of seven hours occurs at the expiration of every sixty-two, during the first three and a half hours of which it gradually diminishes in brightness till it is reduced to a star of the fourth magnitude, and during the remainder of the interval it again gradually increases until it recovers its original magnitude. Thus, if we suppose it to have attained its maximum splendor at midnight on the first day of the month, its changes would be as follows:—

D.	H.	M.	to	D.	H.	M.	
0	0	0	to	2	14	0	It appears of second magnitude.
2	14	0	to	2	17	24	It decreases gradually to fourth magnitude.
2	17	24	to	2	20	48	It increases gradually to second magnitude.
2	20	48	to	5	10	48	It appears of second magnitude.
5	10	48	to	5	14	12	It decreases to fourth magnitude.
5	14	12	to	5	17	36	It increases to second magnitude.
	&c.				&c.		&c.

This star presents an interesting example of its class, as it is constantly visible, and its period is so short that its succession of phases may be frequently and conveniently observed. It is situated near the foot of the constellation *Andromeda* and lies a few degrees northeast of three stars of the fourth magnitude which form a triangle. It passes the meridian of New York in December, at about four o'clock in the afternoon, and may therefore be seen toward the west during the early hours of the night.

Goodricke, who discovered the periodic phenomena of *Algol* in 1782, explained these appearances by the supposition that some opaque body revolves round it, being thus periodically interposed between the earth and the star, so as to intercept a large portion of its light. Whatever be their cause, these phenomena indicate an extraordinary system of rapid motions and changes in

distant regions of the universe where, as Sir John Herschel observes, but for such evidences we might conclude all to be lifeless. Our own sun requires nine times the period of this star to make a single revolution on its axis, and an opaque body sufficiently large to produce a similar temporary obscuration of it to a distant observer, would require to revolve round it in less than fourteen hours.

The star called χ *Cygni*, situate in the neck of the Swan, nearly equidistant from β and γ *Cygni*, affords another interesting example of this class. The period of this star was discovered by Kirch in 1687. When it has its greatest brightness, it appears to be of the sixth magnitude, and when least, it becomes a telescopic star of the eleventh magnitude. Its total period is 396 days and 21 hours. It retains its maximum magnitude for a fortnight. It then decreases gradually for three months and a half, and afterward increases gradually during an equal time. It does not always attain the same maximum brightness, the greatest magnitude varying between the fifth and the seventh.

The following table of periodic stars, exhibiting specimens of every variety of period, has been given by Sir John Herschel:—

Stars' Names.	Period.			Variation of Magnitude.	Discoverers.
	D.	H.	M.		
β Persei	2	20	48	2 to 4	{ Goodricke, 1782. Palitzsch, 1783.
δ Cephei	5	8	37	3.4 — 5	Goodricke, 1784.
β Lyræ	6	9	0	3 — 4.5	Goodricke, 1784.
σ Antinoi	7	4	15	3.4 — 6.5	Pigott, 1784.
α Herculis	60	6	0	3 — 4	Herschel, 1796.
Serpentis RA. 15 ^h 41 ^m PD. 74 ^d 15'	}	180	—	7? — 0	Harding, 1826.
\circ Ceti		334	—	2 — 0	Fabricius, 1596.
χ Cygni	396	21	0	6 — 11	Kirch, 1687.
367 B. * Hydræ	494	—	—	4 — 10	Maraldi, 1704.
34 Fl. Cygni	18	years	—	6 — 0	Janson, 1600.
420 M. Leonis	Many	years	—	7 — 0	Koch, 1782.
κ Sagittarii	Ditto	—	—	3 — 6	Halley, 1676.
ψ Leonis	Ditto	—	—	6 — 0	Montanari, 1667.

What, then, it will be asked, are the probable or possible causes of these singular phenomena? Several explanations, more or less plausible, have been proposed.

1. The phenomena of the spots on the sun have afforded ground for the supposition that the stars, being distant suns, may have patches more or less opaque on their surfaces, which being successively presented toward the earth by the rotation of the star upon an axis, produce the effect of periodical variation in brightness or apparent magnitude. "Such a motion of a star," says Sir William Herschel, "may be as evidently proved, as the diurnal motion of the earth. Dark spots, or large portions of the surface less luminous than the rest, turned alternately in certain directions, either toward or from us, will account for all the phenomena of periodical changes in the lustre of the stars so satisfactorily, that we certainly need not look for any other cause."

The analogy of the spots on the sun, however, is subject to an objection. They certainly would not render the sun a periodic star to the observers of a distant system; for, to say nothing of their inconsiderable magnitude, compared with the entire solar disk, their want of permanence and the irregularity of their appearance and disappearance would entirely preclude such an

* These letters, B., Fl., and M., refer to the catalogues of Bode, Flamsteed, and Mayer.

effect. A periodic star could be caused only by considerable and permanent spots.

2. Newton conjectured that the variation of brightness might be produced by comets falling into distant suns and causing temporary conflagrations. Waiving any other objection to this conjecture, it is put aside by its insufficiency to explain the periodicity of the phenomena.

3. Maupertius has suggested that some stars may have the form of thin flat disks; acquired either by extremely rapid rotation on an axis, or other physical cause. The ring of Saturn affords an example of this within the limits of our own system, and the modern discoveries in nebular astronomy offer other examples of a like form. The axis of rotation of such a body might be subject to periodical change like the nutation of the earth's axis, so that the flat side of the luminous disk might be present more or less toward the earth at different times, and when the edge is so presented it might be too thin to be visible. Such a succession of phenomena are actually exhibited in the case of the rings of Saturn, though proceeding from different causes.

4. Mr. Dunn* has conjectured that a dense atmosphere surrounding the stars, in different parts more or less pervious to light, may explain the phenomena. This conjecture, otherwise vague, indefinite, and improbable, totally fails to explain the periodicity of the phenomena.

5. It has been suggested that the periodical obscuration or total disappearance of the star, may arise from *transits* of the star by its attendant planets. The transits of Venus and Mercury are the basis of this conjecture.

The transits of none of the planets of the solar system, seen from the stars, could render the sun a periodic star. The magnitudes even of the largest of them, are altogether insufficient for such an effect. To this objection it has been answered that planets of vastly greater comparative magnitude may revolve round other suns. But if the magnitude of a planet were sufficient to produce by its transit these considerable obscurations, it must be very little inferior to the magnitude of the sun itself, or, at all events, it must bear a very considerable proportion to the magnitude of the sun; in which case it may be objected that the predominance of attraction necessary to maintain the sun in the centre of its system could not be secured. To this objection it is answered, that although the planet may have a great comparative *magnitude*, it may have a very small comparative *density*, and the gravitating attraction depending on the actual mass of matter, the predominance of the solar mass may be rendered consistent with the great relative magnitude of the planet by supposing the density of the one vastly greater than that of the other. The density of the sun is much greater than the density of Saturn.

6. It has been suggested that there may be systems in which the central body is a planet attended by a lesser sun revolving round it as the moon revolves round the earth, and in that case the periodical obscuration of the sun may be produced by its passage once in each revolution behind the central planet.

Such are the various conjectures which have been proposed to explain the periodic stars and as they are merely conjectures, scarcely deserving the name of hypotheses or theories, we shall leave them to be taken for what they are worth.

TEMPORARY STARS.

Phenomena in most respects similar to those just described, but exhibiting no recurrence, repetition, or periodicity, have been observed in many stars. Thus, stars have from time to time appeared in various parts of the firmament;

* See Phil. Trans., vol. 52.

have shone with extraordinary lustre for a limited time, and have disappeared finally, never having been again observed. Such are called TEMPORARY STARS.

The first star of this class which has been recorded, is one observed by *Hipparchus*, 125 B. C., the disappearance of which is said to have led that astronomer to make his celebrated catalogue of the fixed stars, a work which has proved in modern times of great value and interest. In the 389th year of our era, a star blazed forth near *a Aquilæ*, which shone for three weeks, appearing as splendid as the planet Venus, after which it disappeared and has never since been seen. In the years 945, 1264, and 1572, brilliant stars appeared in the region of the heavens between the constellations of *Cepheus* and *Cassiopeia*. The accounts of the position of these objects are obscure and uncertain, but the intervals between the epochs of their appearances being nearly equal, it has been conjectured that they were successive returns of the same periodic star, the period of which is about 300 years, or possibly half that interval.

The appearance of the star of 1572 was very remarkable, and having been witnessed by the most eminent astronomers of that day, the account of it may be considered to be well entitled to confidence. *Tycho Brahe*, happening to be on his return on the evening of the 11th November from his laboratory to his dwelling-house, was astonished to find a crowd of peasants gazing at a star which he was sure did not exist half an hour before. This was the temporary star of 1572. It was then as bright as the Dog-star, and it continued to increase in splendor until it surpassed Jupiter when that planet is most brilliant, and finally it attained such a lustre, that it was visible at mid-day. It began to diminish in December, and altogether disappeared in March, 1574.

On the 10th October, 1604, a splendid star suddenly burst out in the constellation of *Serpentarius*, which was as bright as that of 1572. It continued visible till October, 1605, when it vanished.

To this class may be referred the cases of numerous stars which have disappeared from the firmament. On a careful examination of the heavens, and a comparison of the objects observed with former catalogues, and of catalogues ancient and modern with each other, many stars formerly known are now ascertained to be missing; and although, as Sir John Herschel observes, there is no doubt that in many instances these apparent losses have proceeded from mistaken entries, yet it is equally certain that in numerous cases there can have been no mistake in the observation or the entry, and that the star has really existed at a former epoch, and as certainly has since disappeared.

When we consider the vast length of many of the periods of astronomical phenomena, it is far from being improbable that these phenomena which seem to be occasional, accidental, and springing from the operation of no regular physical causes, such as those indicated by the class of variable stars first considered, may after all be periodic stars of the same kind, whose appearances and disappearances are brought about by similar causes. All that can be certainly known respecting them is, that they have appeared or disappeared once in that brief period of time within which astronomical observations have been made and recorded. If they be periodic stars, the length of whose period exceeds that interval, their changes could only have been once exhibited to us, and after ages have rolled away, and time has converted the future into the past, future astronomers may witness the next occurrence of their phases, and discover that to be regular, harmonious, and periodic, which appears to us accidental, occasional, and anomalous.

DOUBLE STARS.

When the stars are examined individually by telescopes of a certain power, it is found that many which to the naked eye appear to be single stars, are in reality two stars placed so close together that they appear as one. These are called *double stars*.

A very limited number of these objects had been discovered before the telescope had received the vast accession of power which was given to it by the labor and genius of Sir William Herschel. That astronomer observed and catalogued five hundred double stars, and subsequent observers, among whom his son, Sir John Herschel, holds the foremost place, have augmented the number to six thousand.

The close apparent juxtaposition of two stars on the firmament is a phenomenon which might be easily explained, and which could create no surprise. Such an appearance would be produced by the accidental circumstance of the lines of direction of the two stars as seen from the earth, forming a very small angle, in which case, although the two stars might in reality be as far removed from each other as any stars in the heavens, they would nevertheless *appear* close together. The annexed diagram, fig. 1, will render this easily understood. Let *a* and *b* be the two stars seen from *c*. The star *a* will be seen relatively to *b*, as if it were at *d*, and the two objects will seem to be in close juxtaposition, and if the angle under the lines *c a* and *c b* be less than the sum of the apparent semi-diameters of the stars, they would actually appear to touch.

Fig. 1.

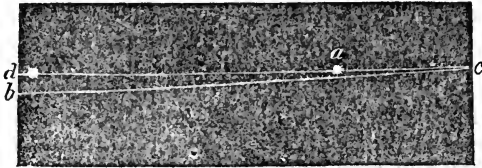

If such objects were few in number, this mode of explaining them might be admitted; and such may in fact be the cause of the phenomenon in some instances. The chances against such proximity of the lines of direction are so great as to be utterly incompatible with the vast number of double stars that have been discovered, even were there not, as there is, other conclusive proof that this proximity and companionship is neither accidental nor merely apparent, but that the connexion is real, and that the objects are united by a physical bond analogous to that which attaches the planets to the sun.

Among the most striking examples of double stars, may be mentioned the bright star *Castor*, which, when sufficiently magnified, is proved to consist of two stars between the third and fourth magnitudes, within five seconds of each other. There are many, however, which are separated by intervals less than one second, such as ϵ *Arietis*, *Atlas Pleiadum*, γ *Coronæ*, η and ζ *Herculis*, and τ and λ *Ophiuchi*.

The telescopic appearance of double stars may be conceived from diagrams of some of the more remarkable of the class, which have been given by Dr. Dick, in his work on the heavens.

Fig. 2 represents a telescopic view of ϵ *Bootis*, with a magnifying power of 200. This is considered to be a very beautiful double star, consisting of a small and large one, the former *blue*, and the latter *red*. The smaller star appears about one third of the size of the larger, and separated from it by a space equal to the diameter of the larger star.

Fig. 3 is α *Herculis*. It consists of a large and small star separated by a space equal to twice the diameter of the larger. The smaller star is blue, and the larger white. This object is situated in the head of the constellation *Hercules*, about thirty degrees southwest of the conspicuous star α *Lyræ*, and six degrees northwest of *Ras Alhague*, a star of nearly equal magnitude.

Figs. 2—18.

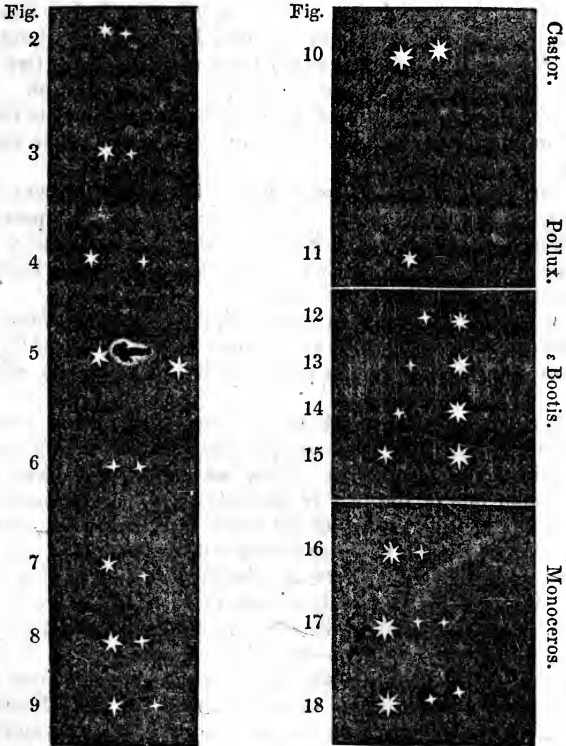

Fig. 4 is a view of γ *Andromedæ*: the small star is of a fine greenish-blue color, separate from the large star about nine seconds, or four diameters of that star; the larger star is of a reddish-white. It is situated in the left foot of *Andromeda*, and is distinguished by the name of *Almaach*. It is a star of the second magnitude, about forty-two degrees of north declination. It is about twelve degrees nearly due west from the variable star *Algol*.

Fig. 5 is ζ *Cygni*: the smaller star is blue, and they are separated about ten diameters. This star is situated in the eastern wing of the *Swan*; right ascension, 21h.4m, north declination twenty-eight degrees, and is about twenty degrees southeast of *Denib*, the principal star of this constellation.

Fig. 6 represents ζ *Aquarii*. The two stars are nearly equal in apparent magnitude, and one diameter and a half separate from each other; both stars are of a whitish color. It is in the middle of other three stars, which together form a figure resembling the letter Y. Its right ascension is 22h.20m, and its south declination about two degrees. It is a star of about the third magnitude.

Fig. 7 represents the *Pole-star*. The accompanying star is a very faint point, and requires an accurate telescope with considerable power to distin-

guish it. The large star is white, and the small star somewhat of a ruddy appearance, and is distant from the larger seventeen seconds, or about three or four of its diameters.

Fig. 8 is the double star *Castor*. The smaller star is nearly half the size of the larger, and they are distant about five seconds, or two diameters of the principal star. They are both of a whitish color. *Castor* and *Pollux* lie to the northwest of *Orion*, at a considerable distance from it. They are very conspicuous, are within five degrees of each other, and rise to a very high elevation when passing the meridian, and may be seen throughout the whole winter and spring months. *Castor* is the more elevated of the two.

Fig. 9 represents *Rigel*, a splendid star in the left foot of *Orion*. The small star is a mere point, and very difficult to be distinguished, and is three or four diameters of the large star from it. The large star is white, the small one of a reddish hue.

Fig. 10 shows the double star *Castor*, with a magnifying power of 300. It likewise shows the angular position of the small star at the present time in respect to *Pollux* (fig. 11), by which it appears that it is nearly at a right angle to a line joining *Castor* and *Pollux*, whereas in the time of Dr. Bradley it was parallel with a line joining these two stars.

Figs. 12, 13, 14, and 15, exhibit views of the double star ϵ *Bootis*, with four magnifying powers. Fig. 12 is its appearance with a power of 227; fig. 13, with a power of 460; fig. 14, with a power of 900; and fig. 15 with a power of 1,100.

Figs. 16, 17, and 18, represent telescopic views of the triple star in the left fore-foot of the constellation *Monoceros*, or the Unicorn, which forms a very beautiful object in this class of stars. This star appears at first double, but with some attention one of the two is discovered to be also double; the first of them is the largest. The color of all these stars is white. With a small power they appear as in fig. 16; with a power of 220, as in fig. 17; and with a power of 450, as in fig. 18. There is a beautiful object of this description, but somewhat different in the configuration of the three stars of which it is composed, to be seen in the tail of the Great Bear; it is the star ζ *Ursæ*, called also *Mizar*, and is the middle star in the tail.

All the objects here enumerated may be seen with a good three and a half feet achromatic telescope, with an object-glass of $2\frac{3}{4}$ inch diameter. The double star *Castor* may be seen with so low a power as 80, but more distinctly with higher magnifiers.

Fig. 19.



When the attention of astronomers was first attracted to double stars, it was thought they would afford a most promising means of determining the annual parallax, and thereby discovering the distance of the stars. If we suppose the two individuals composing a double star, being situate very nearly in the same direction as seen from the earth, to be at very different distances, it might be expected that their apparent relative position would vary at different seasons of the year, by reason of the change of position of the earth.

Let A and B, fig. 19, represent the two individuals composing a double star. Let C and D represent two positions of the earth in its annual orbit, separated by an interval of half a year, and placed therefore on opposite sides of the

sun S. When viewed from C, the star B will be above the star A, and when viewed from D, it will be below it. During the intermediate six months the relative change of position would gradually be effected, and the one star would thus appear either to revolve annually round the other, or would oscillate semi-annually from side to side of the other. The extent of its play compared with the diameter C D of the earth's orbit would supply the data necessary to determine the proportion which the distance of the stars would bear to that diameter.

The great problem of the stellar parallax seemed thus to be reduced to the measurement of the small interval between the individuals of double stars; and it happened, fortunately, that the micrometers used in astronomical instruments were capable of measuring these minute angles with much greater relative accuracy than could be attained in the observations on greater angular distances. To these advantages were added the absence of all possible errors arising from refraction; errors incidental to the graduation of instruments; from uncertainty of levels and plumb-lines; from all estimations of aberration and precession; in a word, from all effects which, equally affecting both the individual stars observed, could not interfere with the results of the observations, whatever they might be.

These considerations raised great hopes among astronomers that the means were in their hands to resolve finally the great problem of the stellar parallax, and Sir William Herschel accordingly engaged with all his characteristic ardor and sagacity in an extensive series of observations on the numerous double stars, to the original discovery of which science was already so deeply indebted to his labors. He had not, however, proceeded far in his researches, when phenomena unfolded themselves before him indicating a discovery of a much higher order and interest than that of the parallax which he sought. He found that the relative position of the individuals of many of the double stars which he examined were subject to a change, but that the period of this change had no relation to the period of the earth's motion. It is evident that whatever appearances can proceed from the earth's annual motion, must be not only periodic and regular, but must pass annually through the same series of phases, always showing the same phase on each return of the same epoch of the sidereal year. In the changes of position which Sir William Herschel observed in the double stars, no such series of phases presented themselves. Periods, it is true, were soon developed, but these periods were regulated by intervals which neither agreed with each other nor with the earth's annual motion.

Some other explanation of the phenomena must therefore be sought for, and the illustrious observer soon arrived at the conclusion that these apparent changes of position were due to real motions in the stars themselves; that these stars in fact moved in proper orbits in the same manner as the planets moved around the sun. The slowness of the succession of changes which were observed rendered it necessary to watch their progress for a long period of time before the motions of these bodies could be certainly or accurately known; and accordingly, although these researches were commenced in 1778, it was not until the year 1803 that the observer had collected data sufficient to justify any positive conclusion respecting their orbital motion. In that and the following year Sir William Herschel announced to the Royal Society, in two memorable papers read before that body, that there exist sidereal systems consisting of two stars revolving about each other in regular orbits, and constituting what he called *binary stars*, to distinguish them from double stars, generally so called, in which no such periodic change of position is discoverable. Such stars may be only *accidentally* double, and, as we have already explained,

may be as distant from each other as any other stars in the firmament, notwithstanding their apparent juxtaposition. But the individuals of a binary star are at the same distance from the eye in the same sense in which the planet Uranus and its attendant satellites are said to be at the same distance.

More recent observation has fully confirmed these remarkable discoveries. The catalogue of binary stars first given by Sir William Herschel, consisting of from fifty to sixty, comprises nearly all the most considerable objects of that class that have yet been detected. These stars require the best telescopes for their observation, being generally so close as to render the use of very high magnifying powers indispensable.

The moment the revolution of one star round another was ascertained, the idea of the possible extension of the great principle of gravitation to these remote regions of the universe naturally suggested itself. Newton has proved in his *Principia*, that if a body revolve in an ellipse by an attractive force directed to the focus, that force will vary according to the law which characterizes gravitation. Thus an elliptical orbit became a *test* of the presence and sway of the law of gravitation. If, then, it could be ascertained that the orbits of the double stars were ellipses, we should at once arrive at the fact that the law of which the discovery conferred such celebrity on the name of Newton is not confined to the solar system, but prevails throughout the universe.

The first distinct system of calculation by which the true elliptic elements of the orbit of a binary star were ascertained, was supplied in 1830, by M. Savary, who showed that the motion of one of the most remarkable of these stars (*ξ Ursæ Majoris*), indicated an elliptic orbit described in $58\frac{1}{2}$ years. Professor Encké, by another process, arrived at the fact that the star *70 Ophiuchi*, moved in an ellipse with a period of 74 years. Several other orbits were ascertained and computed by Sir John Herschel. In the following table, given by that astronomer, are exhibited the principal discoveries in this branch of astronomy:—

Names of Stars.	Period of Revolution.	Major semi-axis of Ellipse.	Eccentricity.
	Years.		
γ Leonis	1200	—	—
γ Virginis	628·9000	12"·090	0·83350
61 Cygni	452·—	15·430	—
σ Coronæ	286·6000	3·679	0·61125
Castor	252·6600	8·086	8·75820
70 Ophiuchi	80·3400	4·392	0·46670
ξ Ursæ	58·2625	3·857	0·41640
ζ Cancri	55 ?	—	—
η Coronæ	43·4000	—	—

The most remarkable of these, says Sir John Herschel, is γ *Virginis*; not only on account of the length of its period, but by reason also of the great minution of apparent distance, and rapid increase of angular motion about each other, of the individuals composing it. It is a bright star of the fourth magnitude, and its component stars are almost exactly equal. It has been known to consist of two stars since the beginning of the eighteenth century, the distance being then between six and seven seconds; so that any tolerable telescope would resolve it. Since that time they have been constantly approaching, and are at present hardly more than a single second asunder, so that no telescope that is not of very superior quality, is competent to them otherwise than as a single star somewhat lengthened in one direction. It fortunately happens, that Bradley, in 1718, noticed and recorded in

the margin of one of his observation-books, the apparent direction of their line of junction, as being parallel to that of two remarkable stars α and δ of the same constellation, as seen by the naked eye; and this note, which has been rescued from oblivion by the diligence of Professor Rigaud, has proved of signal service in the investigation of their orbit. They are entered also as distinct stars in Mayer's catalogue; and this affords also another means of recovering their relative situation at the date of his observations, which were made about the year 1756. Without particularizing individual measurements, which will be found in their proper repositories, it will suffice to remark, that their whole series (which since the beginning of the present century has been very numerous and carefully made, and which embraces an angular motion of 100° , and a diminution of distance to one sixth of its former amount) is represented with a degree of exactness *fully equal to that of observation itself*, by an ellipse of the dimensions and period stated in the following little table, and of which the further requisite particulars are as follows:—

Perihelion passage.	August 18, 1834.
Inclination of orbit to the visual ray, - - - - -	22° 58'
Angle of position of the perihelion projected on the heavens, - -	36° 24'
Angle of position of the line of nodes, or intersection of the plane of the orbit with the surface of the heavens, }	97° 23'

The manner in which the periodic motion of a double star is observed, will be readily apprehended by the aid of the annexed diagram, fig. 20, by which Dr. Dick has represented the observations of Sir William Herschel on the double star *Castor*. In the year 1759 Dr. Bradley had observed the position of the two individuals of this star, and communicated it to Dr. Markelyne. At that time, therefore, it is known that the line joining them was parallel to the line joining the stars *Castor* and *Pollux*, as seen by the naked eye. The following table exhibits the angles which the same joining line made with the meridian of Sir William Herschel's observatory:—

Times of the Observations.	Angles of Position.
November 1, 1759.....	56° 32'
November 5, 1779.....	35 29
February 23, 1791.....	23 36
December 15, 1795.....	18 32
March 26, 1800.....	14 3
December 31, 1801.....	12 12
February 28, 1802.....	12 1
March 27, 1803.....	10 53

It appears, therefore, that in the interval between November, 1759, and March, 1803, a portion of an orbit amounting to 45 degrees and 39 minutes has been described by the smaller star round the greater, or more strictly round their common centre of gravity. This would be at the rate of one degree and three minutes per annum, at which rate a complete revolution would be performed in about 343 years.

Let the small central circle C represent the larger star *Castor*, and D the smaller star, and let the line E F represent the direction of the two stars in a line with the star *Pollux* at E, as observed by Dr. F. In November, 1779, they were found in the position C H from the position they occupied twenty years before; in 1801, they were thirty-three degrees from the same position, &c.; and in March, 1803, forty-six and a half degrees, giving evident indication of a regular progressive motion in a circle. Since 1803 its motion has been regularly traced by Struve, Sir John Herschel, and Sir J. South; and in 1816 it was found about fifty-seven degrees from its first position, and in 1830 about sixty-eight degrees, still regularly progressing. In 1819 the distance of the small star from *Castor*

Fig. 20.

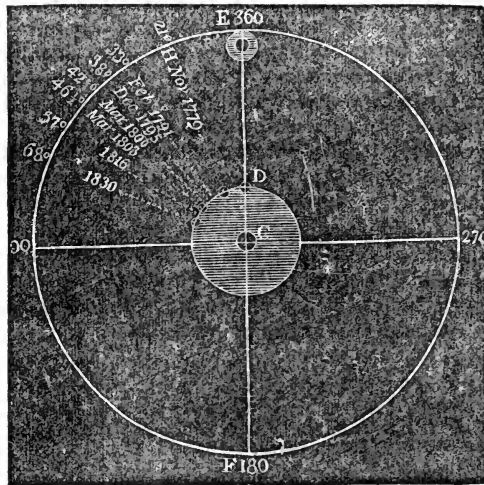

was five seconds and a half, and in 1830 it was a little more than four seconds and a half. Although Sir William Herschel, as above stated, conjectured the period of revolution to be about 343 years, yet later astronomers, from a comparison of all the observations recently made, are disposed to conclude that its period is little more than 250 years.

Thus in each succeeding age has the sagacity and perseverance of astronomers unfolded laws prevailing in the material universe, whose range appears to have no other limit than those of that universe itself. When Galileo, soon after the invention of the telescope, ascertained the existence of the system of Jupiter and his moons, exhibiting on a small scale that of the sun and the planets, and offered it to the world as an analogy strikingly corroborative of the Copernican hypothesis, the announcement of the Florentine observer was received with incredulity, and philosophers themselves rejected it, some declaring that they could not give credence to it, even though attested by the evidence of their senses. What would have been said if the inspiration of Galileo had prompted the anticipation of sun revolving round sun—of system revolving round system united by the same ruling principle—bound by the same tie, and exhibiting a regular subordination to the same laws, which confer such stability, harmony, and regularity, on the movements of the solar system! Such are the results which these stellar discoveries bring before us. A stupendous luminous globe, surrounded by a system of planets with their attendant satellites, presides in the centre. Around it, at a distance incomparably greater than the distances of its planets, circulates *another sun*, attended by another system of planets and satellites similar to the first, but on a reduced scale! The lights of these associated suns are of different hues, but their tints are so related, that when blended together they will produce a daylight like that of the solar system. The distances of the planets composing each of these systems, from their respective suns, bear a proportion to the distance which intervenes between these suns similar, doubtless, to that which the distances of the satellites of Jupiter or Saturn bear to the distances of these planets from the sun. "A less distinctly characterized subordination would," as Sir John Herschel observes, "be incompatible with the stability of their system, and with the planetary nature of their orbits. Unless closely nestled

under the protecting wing of their immediate superior, the sweep of their other sun in its perihelion passage round their own, might carry them off, or whirl them into orbits utterly incompatible with the conditions necessary for the existence of their inhabitants. It must be acknowledged that such a spectacle presents a strangely wild and novel field for speculative excursions, and one which it is difficult to avoid luxuriating in."

Those who are unaccustomed to the consideration of geometrical questions will be enabled to acquire a tolerably clear idea of such a system as has been just described by means of the annexed diagram.

Fig. 21.

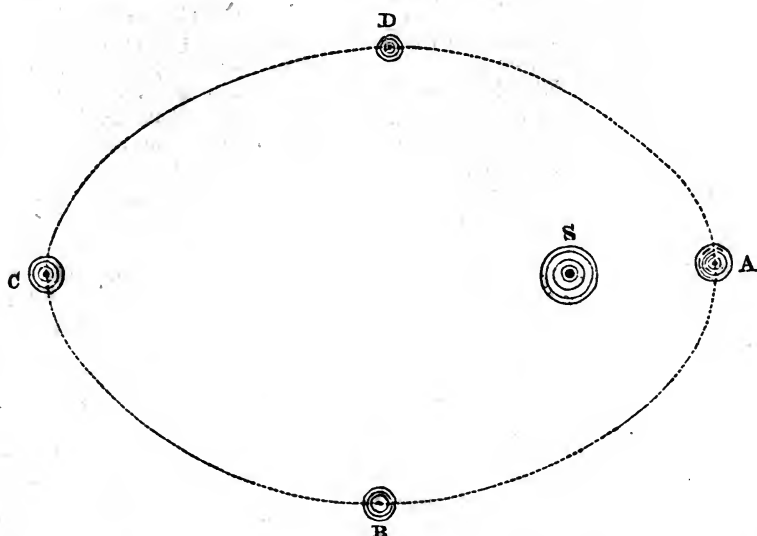

The larger sun with its planets is represented at S, in the focus of an ellipse, in which the lesser sun accompanied by its planets moves. At A, this latter sun is in its perihelion, and nearest to the greater sun S. Moving in its periodical course to B, it is at its mean distance from the sun S. At C it is at aphelion, or its most distant point, and finally returns through D to its perihelion A. The sun S, because of its vast distance from the system A, would appear to the inhabitants of the planets of the system A much smaller than their proper sun, but on the other hand this effect of distance would be to a certain extent compensated by its greatly superior magnitude; for analogy justifies the inference that the sun S is greater than the sun A in a proportion equal to that of the magnitude of our sun to one of the planets. The inhabitants of the planets of the system A will then behold the spectacle of *two suns* in their firmament. The annual motion of one of these suns will be determined by the motion of the planet itself in its orbit, but that of the other and more distant sun will be determined by the period of the lesser sun around the greater in the orbit A B C D. The rotation of the planets on their axes will produce two days of equal length, but not commencing or ending simultaneously. There will be in general *two sunrises* and *two sunsets*! When a planet is situated in the part of its orbit *between* the two suns, there will be no night. The two suns will then be placed exactly as our sun and moon are placed when the moon is full. When the one sun sets the other will rise, and when the one rises the other will set. There will be, therefore, continual day. On the other hand, when

a planet is at such a part of its orbit that both suns lie in nearly the same direction as seen from it, both suns will rise and both will set together. There will then be the ordinary alternation of day and night as on the earth, but the day will have more than the usual splendor, being enlightened by two suns.

In all intermediate seasons the two suns will rise and set at different times. During a part of the day both will be seen at once in the heavens, occupying different places, and reaching the meridian at different times. There will be *two noons*. In the morning for some time, more or less, according to the season of the year, one sun only will be apparent, and in like manner, in the evening the sun which first rose will be the first to set, leaving the dominion of the heavens to its splendid companion.

The diurnal and annual phenomena incidental to the planets attending the central sun S, will not be materially different, except that to them the two suns will have extremely different magnitudes, and will afford proportionally different degrees of light. The lesser sun will appear much smaller, both on account of its really inferior magnitude and its vastly greater distance. The two days, therefore, when they occur, will be of very different splendor, one being probably as much brighter than the other as the light of noonday is to that of full moonlight, or to that of the morning or evening twilight.

But these singular vicissitudes of light will become still more striking when it is remembered that the two suns diffuse light of different colors. Let us examine the very common case of the combination of a *crimson* with a *blue* sun. In general they will rise at different times. When the blue rises, it will for a time preside alone in the heavens, diffusing a blue morning. Its crimson companion, however, soon appearing, the lights of both being blended, a white day will follow. As evening approaches, and the two orbs descend toward the western horizon, the blue sun will first set, leaving the crimson one alone in the heavens. Thus a ruddy evening closes this curious succession of varying lights. As the year rolls on, these changes will be varied in every conceivable manner. At those seasons when the suns are on opposite sides of a planet, crimson and blue days will be alternate, without any intervening night; and at the intermediate epochs all the various intervals of rising and setting of the two suns will be exhibited.

"Other suns, perhaps,
With their attendant moons, thou wilt descry,
Communicating male and female light
(Which two great sexes animate the world),
Stored in each orb, perhaps, with some that live."
PARADISE LOST, viii, 148.

PROPER MOTION OF THE STARS.

In common parlance the stars are said to be *fixed*. They have received this epithet to distinguish them from the planets, the sun, and the moon, all of which constantly undergo changes of apparent position on the surface of the heavens. The stars, on the contrary, so far as the powers of the eye unaided by art can discover, never change their relative position in the firmament, which seems to be carried round us by the diurnal motion of the sphere, just as if the stars were attached to it, and merely shared in its apparent motion.

But the stars, though subject to no motion perceptible to the naked eye, are not absolutely fixed. When the place of a star on the heavens is exactly observed by means of good astronomical instruments, it is found to be subject to a change from month to month and from year to year, small indeed, but still easily observed and certainly ascertained.

It has been demonstrated by Laplace that a system of bodies, such as the

solar system, placed in space, and submitted to no other continued force except the reciprocal attractions of the bodies which compose it, must either have the common centre of gravity stationary or in a state of uniform rectilinear motion.

The chances against the conditions which would render the sun stationary, compared with those which would give it a motion in *some* direction, with *some* velocity, are so numerous that we may pronounce it to be morally certain that our system is in motion in some determinate direction through the universe. Now if we suppose the sun attended by the planets to be thus moved through the universe in any direction, an observer placed on the earth would observe the effects of such a motion, as a spectator in a steamboat moving on a river would perceive his progressive motion on the stream by an apparent motion of the banks in a contrary direction. The observer on the earth would therefore detect such a motion of the solar system through space by the apparent motion in the contrary direction with which the stars would be affected.

Such a motion of the solar system would affect different stars differently. All would, it is true, appear to be affected by a contrary motion, but all would not be equally affected. The nearest would appear to have the most perceptible motion, the more remote would be affected in a less degree, and some might, from their extreme distance, be so slightly affected as not to exhibit any apparent change of place, even when examined with the most delicate instruments. To whatever degree each star might be affected, all the changes of position would, however, apparently take place in the same direction.

The apparent effects would also be exhibited in another manner. The stars in that region of the universe toward which the motion of the system is directed would appear to recede from each other. The spaces which separate them would seem to be gradually augmented, while, on the contrary, the stars in the opposite quarter would seem to be crowded more closely together, the distances between star and star being gradually diminished. This will be more clearly comprehended by the annexed diagram.

Fig. 22.

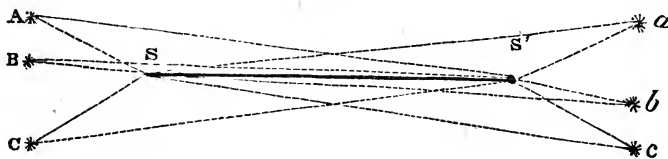

Let the line $S S'$ represent the direction of the motion of the system, and let S and S' represent its positions at any two epochs. At S , the stars $A B C$ would be separated by intervals measured by the angles $A S B$, and $B S C$, while at S' they would appear separated by the lesser angles $A S' B$, and $B S' C$. Seen from S' , the stars $A B C$ would seem to be closer together than they were when seen from S . For like reasons the stars $a b c$, toward which the system is here supposed to move, would seem to be closer together when seen from S , than when seen from S' . Thus, in the quarter of the heavens toward which the system is moving, the stars might be expected to separate gradually, while in the opposite quarter they would become more condensed. In all the intermediate parts of the heavens they would be affected by a motion contrary to that of the solar system. Such in general would be the effects of a progressive motion of our system.

If phenomena like these were clearly ascertained among the stars, the motion of the solar system would be proved; but on the other hand, such appearances not being discovered, we must infer, not the quiescence of the system, but the absence of any motion sufficiently rapid to produce an observable effect on the apparent positions of bodies so distant as the fixed stars. In a word, it must be concluded, that within the limited period of time over which astronomical observation has extended, the space through which the solar system has moved must bear an inappreciable ratio to the distances of the stars.

In the course of his various astronomical labors, the late Sir William Herschel imagined at one time that he had ascertained among the apparent changes incidental to the firmament, indications of a movement of the solar system toward a point of the universe occupied by some of the stars composing the constellation of *Hercules*. This conjecture has not, however, been sustained by subsequent surveys of the heavens; and the opinion among astronomers now is that no sufficient data have yet been attained to warrant any distinct conclusion regarding the progressive motion common to the bodies of our system.

The late astronomer royal of England (Mr. Pond), suggested a mode of investigating the motion of the solar system, marked by singular ingenuity and refinement. It is known that the motion of light combined with that of the earth in its annual orbit, produces an effect on the apparent places of all objects in the heavens, by which they are seen advanced beyond their true positions, always in the direction in which the earth is moving, and the extent of this apparent displacement depends on the proportion which the earth's orbital velocity bears to the velocity of light. This effect is called the *aberration of light*. Now if the sun, together with the planets, have any progressive motion through space, the velocity of such motion would probably be much greater than the orbital velocity of the earth. Such a motion would then be attended with an aberration of the stars, greater in amount than that which is due to the earth's motion. Such an aberration would cause all the stars to be displaced to the same extent and in the same direction, and consequently it would cause no change in their relative positions. We should under such circumstances have no means of detecting it. But if, in the lapse of ages, the velocity of the solar system were to undergo any change of sufficient amount, or if the direction of its motion were to be changed (as would certainly happen if our system were moving in an orbit round any other, owing to any combination like those of the double stars), then the quantity or direction of the consequent aberration would be changed, the relative position of the stars would be consequently disturbed, and the effects would become perceptible. Such effects have not been yet observed, but this suggestion may afford future astronomers the means of ascertaining the motion of our system.

But although no appearances have been discovered, such as a progressive motion of our system would produce, yet other phenomena have been unfolded which prove that the fixed stars are not absolutely stationary, and which indicate physical powers in active operation in distant regions of the universe, on a scale commensurate with the enormous distances and magnitudes which telescopic research has unfolded. The stars, examined individually with instruments of sufficient power and precision, have been found to be subject to changes of position which, though small, are very perceptible, and are certainly ascertained. These changes are called the *proper motions* of the stars.

These proper motions are not the same in all stars. In some no such motion

is discovered. In most of those in which it has been discovered, its amount, even after the lapse of years, is still but small. In one or two it is sufficiently great to be detected by very ordinary means of astronomical observation. The greatest proper motion which has hitherto been observed in any single star is found in the star μ in the constellation of *Cassiopeiæ*. The annual displacement of this star amounts to $3''.74$, so that in 500 years it will be removed from the place it now occupies by a space equal to the apparent diameter of the moon. The annual proper motion of *Arcturus* is about half that of μ *Cassiopeiæ*. In the following table is collected the proper motions as they affect the declination and right ascension of some of the stars in which this phenomenon is most conspicuous. The sign + prefixed to the annual variation, shows that it is to be *added*, and — that it is to be *subtracted*, to find the true place of the object at any time:—

Names of the Stars.	Magnitude.	Annual Motion in	Annual Motion in
		R. A.	Dec.
		Seconds.	Seconds.
Capella.....	1	+0.21	+0.44 N.
Sirius.....	1	-0.42	+1.04 S.
Castor.....	1	-0.15	+0.44 S.
Procyon.....	1.2	-0.80	+0.95 S.
Pollux.....	2	-0.74	0.00
β Leonis.....	1.2	-0.57	+0.07 S.
β Virginis.....	3	+0.74	+0.24 S.
Arcturus.....	1	-1.26	+1.72 S.
Altair.....	1.2	+0.48	-0.54 N.
α Lyræ.....	1	+0.23	-0.27 N.
Antares.....	1	0.00	-0.26 N.

But it is among the double stars that we find the most remarkable examples of proper motion. These systems, while their component stars revolve one round the other, or rather round their common centre of gravity, seem to be carried forward in some determinate direction with a motion in which they both participate. Thus the individuals which compose the double star 61 *Cygni* (of which Professor Bessel has discovered the annual parallax), have remained constantly at nearly the same distance from each other for sixty years last past, but have at the same time been continually shifting their position on the firmament, and are now about five minutes from the place they occupied sixty years ago. In 350 years this double star will move over a space on the firmament equal to the diameter of the moon.

The only conceivable explanation of the phenomena of the proper motions of the stars, is the supposition that these bodies actually have real motions through space, such as to produce the apparent changes of position which we observe. If the distance of any star having a proper motion be known, the rate at which it moves may be easily calculated. Thus, if we assume the distance of 61 *Cygni*, as determined by Bessel's observations on the parallax, to be 60,000,000,000 miles, their motion must be at the rate of one hundred and seventy-seven thousand miles an hour, in order to produce the apparent annual displacement which has been observed. This velocity would be double that of the orbital motion of the earth.

Among the proper motions of the stars, there is no apparent relation—nothing to lead to the conjecture that these phenomena are ascribable to any common physical cause affecting at once all these bodies. We must then infer that they are independent motions affecting these distant systems—inde- pendent at least, so far as our present knowledge extends.

The first part of the book is devoted to a general history of the world, from the beginning of time to the present day. It is written in a simple and plain style, and is intended for the use of the young. The second part of the book is devoted to a history of the United States, from the first settlement to the present day. It is written in a simple and plain style, and is intended for the use of the young. The third part of the book is devoted to a history of the world, from the beginning of time to the present day. It is written in a simple and plain style, and is intended for the use of the young.

THE STELLAR UNIVERSE.

(SECOND LECTURE.)

Form and Arrangement of the Mass of visible Stars.—Sir W. Herschel's Analysis of the Heavens.—
The Milky Way.—The vast Numbers of Stars in it.—Form and Dimensions of this Mass of Stars.—
Nebulæ and Clusters.—Various Forms and Appearance of Nebulæ.—Great Nebula in Orion.—
Magallanic Clouds.—Planetary Nebulæ.—Vast Number of Nebulæ.—Herschel's Catalogue.—
Structure of the Universe.—Laplace's nebular Hypothesis.—Examination of its moral Tendency.

THE [illegible] [illegible]

[illegible text]

THE STELLAR UNIVERSE.

(SECOND LECTURE.)

THE extent of the survey of the universe which is commanded by our natural vision, unaided by those expedients which the inventions in optics have supplied, has been on another occasion fully explained.* We have shown that objects placed around us within the scope of a radius of such a length that light would take about a hundred and twenty years to move over it, are thus perceivable by us. It does not, however, follow, therefore, that *all objects* within that radius are visible. There may be within it stars which fail to be seen; not because of their comparative remoteness, but because of their comparatively inferior intrinsic splendor; and we may infer that interminable realms of space must extend beyond that limit, teeming with innumerable suns and systems, like those which are so abundantly manifested within it.

An attempt was made by the late Sir William Herschel to ascertain by immediate observation the manner in which those stars which are *individually* visible to us, whether by the naked eye or by the telescope, are distributed through space. Are they casually scattered in all directions, without any definite limit of distance, or any definite form? Has their entire mass any ascertainable shape or dimensions? Is it of a regular form, such as a sphere or a cube? And if it have definite limits, how has it pleased Omnipotence to manifest itself in those unfathomed regions which stretch in all directions around that finite and limited mass of systems?

It will be recollected that on a former occasion it was shown, that by the successive application of telescopes of augmented space-penetrating power, we are enabled to bring into view individual stars more and more remote. Denominating the nearest and brightest stars to be at the first order of distance; those within twice that radius to be in the second order of distance; those within three times that radius to be in the third order of distance, and so on; the

* See the lecture on "The Visible Stars."

naked eye being capable of perceiving stars until we attain to the twelfth order of distance. The telescope then carries our view still further, and by the highest powers to which it has hitherto attained, it brings within our view stars which may be considered to be at the 2,400th order of distance, and from which light would therefore take 24,000 years to come.

Armed with such powers, Sir William Herschel commenced the unparalleled enterprise of a general survey of the stellar universe. It was easily rendered apparent that our system is placed within a mass of suns of vast extent and countless number. The few which immediately surround us appear by their comparative proximity largest, or rather brightest, and are accordingly classed as stars of the first magnitude. Those which lie immediately beyond them, occupying a wider circle, and proportionally more numerous, are, by reason of their greater distance, of inferior magnitude. Thus, the greater the distance we contemplate, and the wider the circle over which the stars are distributed, the greater they are found to be in number, and the less intense in splendor.

These observations are not applicable alone to the stars visible to the naked eye. Direct the most ordinary telescope to any quarter of the heavens, and move it slowly about so as to sweep a small portion of the firmament, and it will be found that many stars will be visible in it which were before not observable. Such stars lie beyond the sphere of natural vision.

But is the system to which the earth is attached surrounded by an equal depth of stars in every direction? Is it in the centre of a globular mass of stars? and if so, what order of distance is to be assigned to the most remote of these surrounding suns? If not, must we not expect to find stars smaller and more thickly crowded together in those directions where they extend to more remote distances than in those where they are more limited in their distance?—Just as we should find the appearance of the stems of the trees if we stood in the middle of a wood which is narrow in one direction and long in another? These questions can be satisfactorily resolved only by a general examination of the entire firmament, and by observing whether the stars are more numerous, smaller, and more thickly crowded together in some regions than in others.

There is a remarkable band, or zone, which surrounds the firmament, forming very nearly a great circle of the heavens, and presenting to the naked eye the appearance of a cloudy or nebulous whiteness. This has been called the *Via Lactea* or the *Milky Way*. Its course, which however is not regular, has a direction nearly at right angles to the celestial equator, intersecting that circle at two points, one of which is near the belt of *Orion*, and the other near the constellation of *Aquila*, rendered conspicuous by the bright star *Atair*, just on the verge of the *Milky Way*. If we take a general view of the heavens, even without the aid of a telescope, we shall find that in those regions most remote from this remarkable zone, the stars are thinly scattered, and as we approach it in any direction they become smaller, more numerous, and more crowded. This becomes still more strongly manifested when we resort to telescopes, by which (when of sufficient space-penetrating power), the astonishing fact is disclosed that this whitish zone consists entirely of small stars, too minute to be individually distinguished without a telescope, and which are scattered by countless millions, "like glittering dust on the black ground of the general heavens."

"A broad and ample road, whose dust is gold,
And pavement stars, as stars to us appear;
Seen in the galaxy that *Milky Way*,
Like to a circling zone powdered with stars."—MILTON.

These phenomena led Sir William Herschel to the conclusion that the stars of our firmament, instead of being scattered in all directions indifferently through space, form a stratum, of which the thickness is small in comparison with its length and breadth; and in which the earth occupies a place somewhere about the middle of its thickness, and near the point where it subdivides into two principal laminæ, inclined at a small angle to each other. For it is

Fig. 1.

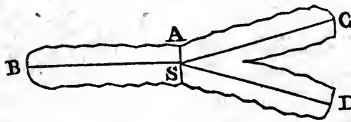

certain that, to an eye so situated, the apparent density of the stars, supposing them pretty equally scattered through the space they occupy, would be least in a direction of the visual ray (as S A), perpendicular to the laminæ, and greatest in that of its breadth, as S B, S C, S D; increasing rapidly in passing from one to the other direction, just as we see a slight haze in the atmosphere thickening into a decided fog-bank near the horizon, by the rapid increase of the mere length of the visual ray. Accordingly, such is the view of the construction of the starry firmament taken by Sir William Herschel, whose powerful telescopes have effected a complete analysis of this wonderful zone, and demonstrated the fact of its entirely consisting of stars. So crowded are they in some parts of it, that by counting the stars in a single field of his telescope, he was led to conclude that 50,000 had passed under his review in a zone two degrees in breadth, during a single hour's observation. The immense distances at which the remoter regions must be situated, will sufficiently account for the vast predominance of small magnitudes which are observed in it.*

The appearance which this mass of stars would present if viewed from a position directly above its general plane, and at a sufficient distance to allow its entire outline to be discerned, was represented by Sir William Herschel as resembling the annexed drawing, fig. 2.

He considered that it was probable that the *thickness* of this *bed of stars* was equal to about eighty times the distance of the nearest of the fixed stars from our system; and supposing our sun to be at the middle of this thickness, it would follow that the stars on its surface in a direction perpendicular to its general plane would be at the fortieth order of distance from us. The stars placed in the more remote edges of its *length* and *breadth* he estimated to be in some places at the nine-hundredth order of distance from us, so that its extreme length may be said to be in round numbers about two thousand times the distance of the nearest fixed stars from our system. Such a space light would take twenty thousand years to move over, moving all that time at the rate of two hundred thousand miles between every two ticks of a common clock!

The great splendor of that part of the Milky Way which passes through the southern hemisphere, and some other peculiarities which he has remarked in it, has suggested to Sir John Herschel a corroboration of his father's theory of its form. "The general aspect of the southern circumpolar region," says Sir John, "including in that expression 60° or 70° of S. P. D.,† is in a high degree rich and magnificent, owing to the superior brilliancy and larger development of the Milky Way: which, from the constellation of Orion to that of Antinous, is in a blaze of light, strangely interrupted, however, with vacant

* Herschel's Astronomy, chap. x.

† Southern polar distance.

Fig. 2.



and almost starless patches, especially in Scorpio, near α Centauri and the cross; while to the north it fades away pale and dim, and is in comparison hardly traceable. I think it is impossible to view this splendid zone, with the astonishingly rich and evenly-distributed fringe of stars of the third and fourth magnitudes, which form a broad skirt to its southern border, like a vast curtain—without an impression, amounting to a conviction, that the Milky Way is not a mere stratum, but an annulus; or, at least, that our system is placed within one of the poorer and almost vacant parts of its general mass, and that eccentrically, so as to be much nearer to the parts about the cross, than to that diametrically opposed to it.”

When a telescope is directed to the heavens, the actual space it renders visible at one time, technically called a *field of view*, is small in the same proportion as the magnifying power of the instrument is great. Thus a telescope of a certain magnifying power will present to the observer the complete disk

of the moon, which may perhaps occupy its entire field of view. A magnifying power twice as great will show at once only half the moon's apparent diameter, and therefore only a fourth of its entire disk. One of three times the power would show only one third of its diameter, and one ninth of its disk, and so on. Let it be remembered, then, that some of the magnifying powers with which the researches of Sir William Herschel were made, gave a field of view not so great as a fourth part of the moon's disk, and we shall form some idea, however inadequate and obscure, of the profusion of evidences of creative power which the firmament presented to that observer. He states that in those parts of the Milky Way in which the stars were most thinly scattered, he saw upon an average eighty stars in each field. In an hour, fifteen degrees of the firmament were carried before his telescope, showing successively sixty distinct fields. Allowing eighty stars for each field, there were thus exhibited to his astonished view in a single hour without moving the telescope four thousand eight hundred distinct stars! But by moving the instrument at the same time in the vertical direction, he found that in a space of the firmament not more than fifteen degrees long by four degrees broad, he was able to observe fifty thousand stars large enough to be individually visible and distinctly counted! The surprising character of this result will be more adequately appreciated if it is remembered that this number of stars thus seen in a space of the heavens not more than thirty diameters of the moon's disk in length and eight in breadth, is fifty times greater than all the stars taken together which the naked eye can perceive at any one time in the heavens on the most serene and unclouded night! And this, be it observed, is in that part of the Milky Way which is most sparsely strewn with stars! What are we to say of the richer parts?

On presenting the telescope to the richer portions of the *Via Lactea*, Herschel found, as might be expected, much greater numbers of stars. In a single field he was able to count 588 stars, and for fifteen minutes, the firmament being moved before his telescope by the diurnal motion, no diminution of number was apparent, so that he estimated that in that space of time 116,000 stars must have passed in review before him; the number seen at any one time being greater than can be seen by the naked eye on the entire firmament, except on the clearest nights.

It appears, then, that our sun is an individual star, forming only a single unit in a cluster or mass of many millions of other similar stars; that this cluster has limited dimensions, has ascertainable length, breadth, and thickness, and in short, forms what may be expressed by a *universe of solar systems*. The mind, still unsatisfied, is as urgent as before in its questions regarding the *remainder of immensity*! However vast the dimensions of this mass of suns be, they are nevertheless finite. However stupendous be the space included within them, it is still *nothing* compared to the immensity which lies outside! Is that immensity a vast solitude? Are its unexplored realms dark and silent? Has Omnipotence circumscribed its agency, and has infinite Beneficence left those unfathomed regions destitute of evidence of its power?

That the infinitude of space should exist without a purpose, unoccupied by any works of creation, is plainly incompatible with all our notions of the character and attributes of the Author of the universe, whether derived from the voice of revelation or from the light of nature. We should therefore infer, even in the absence of direct evidence, that *some* works of creation are dispersed through those spaces which lie beyond the limits of that vast stellar cluster in which our system is placed. Nay, we should be led by the most obvious analogies, to conjecture that *other stellar clusters* like our own, are

dispersed through immensity, separated probably by distances as much greater than those which intervene between star and star as the latter are greater than those which separate the bodies of the solar system. But if such distant clusters existed, it may be objected, that they must be visible to us; that although diminished, perhaps, to mere spots on the firmament, they would still be rendered apparent, were it only as confused whitish patches, by the telescope; that, as the stars of the Milky Way assume to the naked eye the appearance of mere whitish nebulosity, so the far more distant stars of other clusters, which can not be perceived at all by the naked eye, would, to telescopes of adequate power, present the same whitish nebulous appearance; and that we might look forward without despair to such augmentation of the powers of the telescope as may even enable us to perceive them to be actual clusters of stars.

Such anticipations have accordingly been realized. In various parts of the firmament objects are seen which, to the naked eye, appear like stars seen

Fig. 3

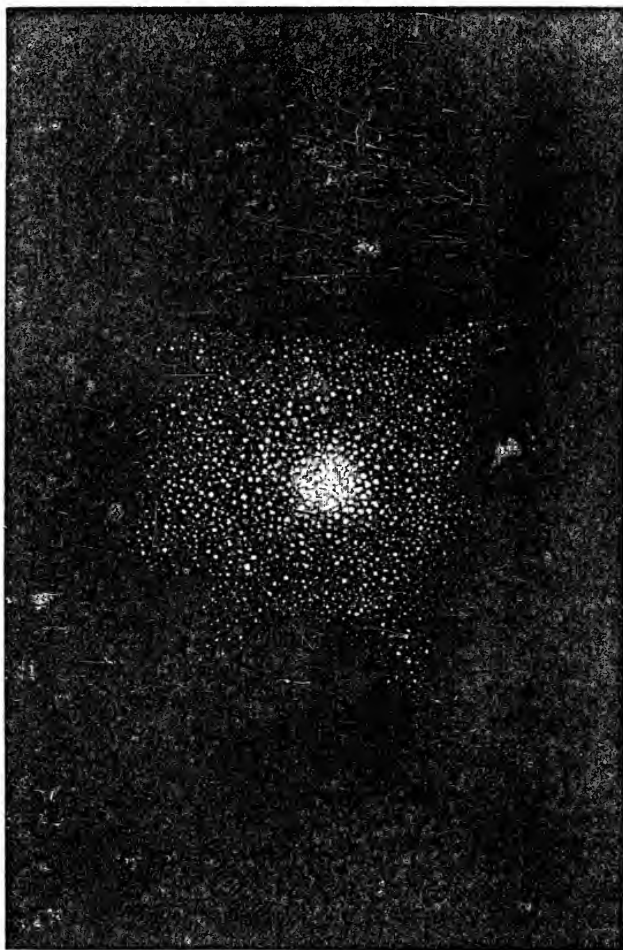

through a mist, and sometimes as nebulous specks, which might be, and not unfrequently are, mistaken for comets. With ordinary telescopes these objects are visible in very considerable numbers, and were observed nearly a century ago. In the *Connaissance des Temps*, for 1784, *Messier*, then so celebrated for his observations on comets, published a catalogue of 103 objects of this class, of many of which he gave drawings, and with which all observers who search for comets ought to be familiar to avoid being misled by their resemblance to them. The improved powers of the telescope speedily disclosed to astronomers the nature of these objects, which, when examined by sufficient magnifying powers, prove to be masses of stars clustered together in a manner identical with that cluster in which our sun appears to be placed. They appear as they do, mere specks of whitish light, because of their enormous distance. Many of them are of a round figure, and convey the idea of a globular space filled full of stars insulated in the heavens, and constituting in itself a family or society apart from the rest, and subject only to its own internal laws. The task were vain to attempt to count the stars in one of these globular clusters. They are not to be reckoned by hundreds; and on a rough calculation, grounded on the apparent intervals between them at the borders (where they are not seen projected on each other), and the angular diameter of the whole group, it would appear that many clusters of this description must contain at least from ten to twenty thousand stars, compacted and wedged together in a round space whose visible magnitude is not a tenth part of that of the disk of the moon.*

One of these objects (the 13th, in *Messier's* catalogue), is represented in the annexed diagram, fig. 3.

This, as Sir John Herschel observes, is exhibited by the telescope as consisting entirely of stars crowded together so as to present an almost definite outline, and to run up to a blaze of light in the centre, where their condensation is usually greatest. This beautiful object was first seen by Halley, in 1714. It is visible to the naked eye between the stars μ and ζ in the constellation of Hercules. If an imaginary line be drawn from the star (first magnitude) α Lyrae, to the star β (second magnitude), in the constellation of Hercules, it will pass through this nebula near the latter star.

In fig. 4, annexed, is exhibited a sketch of one of the most remarkable nebulae in the firmament. This is the 27th in *Messier's* catalogue. Its form may be likened to an hour-glass, a double-headed shot, or a dumb-bell, surrounded by a thin hazy atmosphere. This belongs to a class of nebulae which show an evident symmetry of form. It consists, according to Sir John Herschel's observations, of two bright and highly-condensed round or rather oval nebulae, united by a short neck of nearly the same density. A faint nebulous atmosphere completes the figure, enveloping them both, and filling up the outline of a circumscribing ellipse, whose shorter axis is the symmetrical axis of the system, or the line passing through the centres of both the chief nebulous masses.

In fig. 5 is presented a nebula of an elliptical form, which is visible to the naked eye. In the latitude of New York it passes near the zenith at about nine o'clock at night in the month of November, and in the following months may be seen in the evenings in the northwest, at a considerable altitude. It appears like a dull, cloudy, undefined spot upon the concave of the firmament, and has sometimes been compared to the light of a small candle seen through horn. Its central parts appear brightest, but its light gradually fades away toward each extremity. A few small stars appear adjacent to it, but they have no immediate connexion with the nebula. Its length is nearly equal to the

* Herschel, chap. xii.

Figs. 4—8.

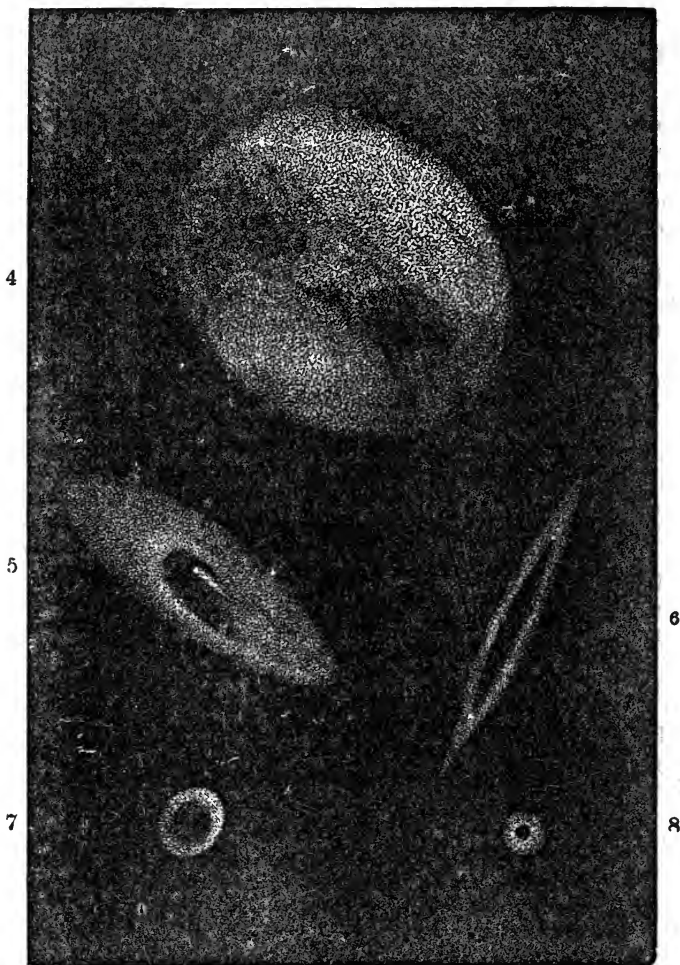

apparent diameter of the moon, and its greatest breadth a little less than half its length.

It has been conjectured that this, and similar nebulae, are in reality flat circular strata of stars, which are rendered elliptical by projection, being seen in a direction oblique to their plane, and having their diameters foreshortened into the lesser axis of the ellipse.

In fig. 6, is represented an elliptical spindle-shaped nebula, placed very near that represented in fig. 5. This form of nebulae is very common, and is generally supposed to be produced by an annular mass or ring of stars, which, being seen very obliquely, appears of the elongated form here depicted. Two annular nebulae, seen in directions nearly perpendicular to their planes, and therefore not foreshortened, are represented in fig. 7 and fig. 8. The former is situated between the stars α and β *Lyrae*, and may be seen with a telescope of moderate power. It is well-defined, and is slightly elliptical in its form.

Figs. 9—10.

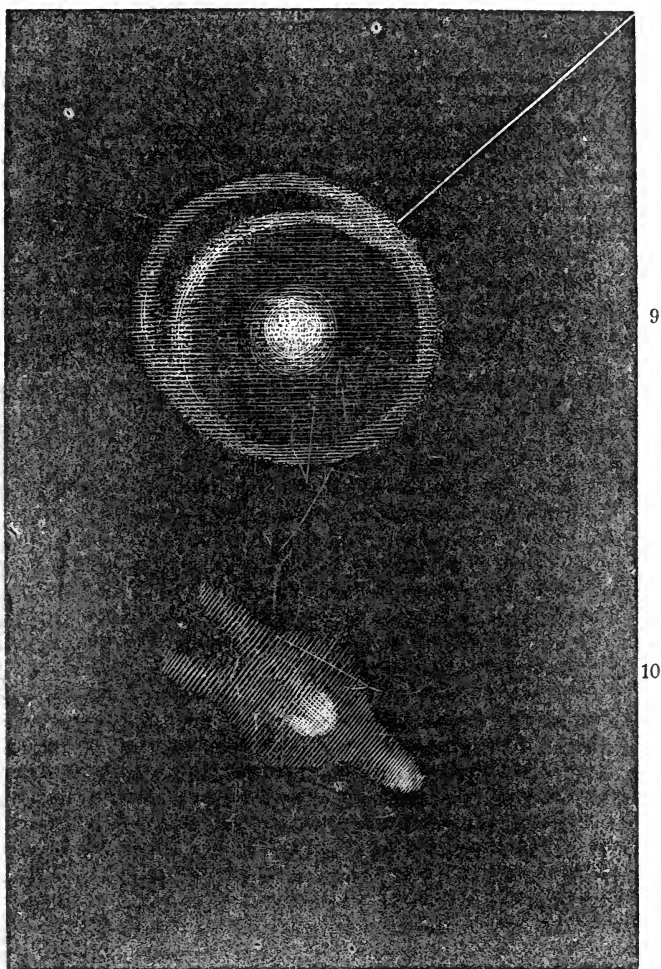

The open space within the ring is not entirely dark, but seems filled with a faint hazy nebulosity. The nebula represented in fig. 8, is situated near the star γ , in the constellation of the Swan, and is seen on the meridian about the 10th September, at nine in the evening. In the parallel of New York it passes the meridian about ten degrees south of the zenith.

A sketch is given in fig. 9 of one of the most remarkable nebulae in the heavens. This object is situated about five degrees south by west of η , the last star in the tail of the Great Bear. It consists of a bright round nebulous central spot, surrounded at a great distance by a nebulous ring, which seems to be split into two throughout nearly half of its circumference, the two portions being separated by an angle of about 45° . This object is thus noticed by Sir John Herschel, in his Memoir on Nebulae (Phil. Trans., 1833):—

“This very singular object is thus described by Messier: ‘Nébuluse sans étoiles. On ne peut la voir que difficilement avec une lunette ordinaire de $3\frac{1}{2}$

pieds. Elle est double, ayant chacune un centre brillant éloigné l'un de l'autre de $4' 35''$. Les deux atmosphères se touchent.' By this description it is evident that the peculiar phenomena of the nebulous ring which encircles the central nucleus had escaped his observation, as might have been expected from the interior light of his telescopes. My father describes it in his observations of Messier's nebulae (which are not included in his catalogues), as a bright round nebula, surrounded with a halo of glory at a distance from it, and accompanied by a companion; but I do not find that the partial subdivision of the ring into two branches throughout its south following limb was noticed by him. This is, however, one of its most remarkable and interesting features. Supposing it to consist of stars, the appearance it would present to a spectator placed on a planet attendant on one of them, eccentrically situated toward the north preceding quarter of the central mass, would be exactly similar to that of our Milky Way, traversing in a manner precisely analogous the firmament

Figs. 11—12.

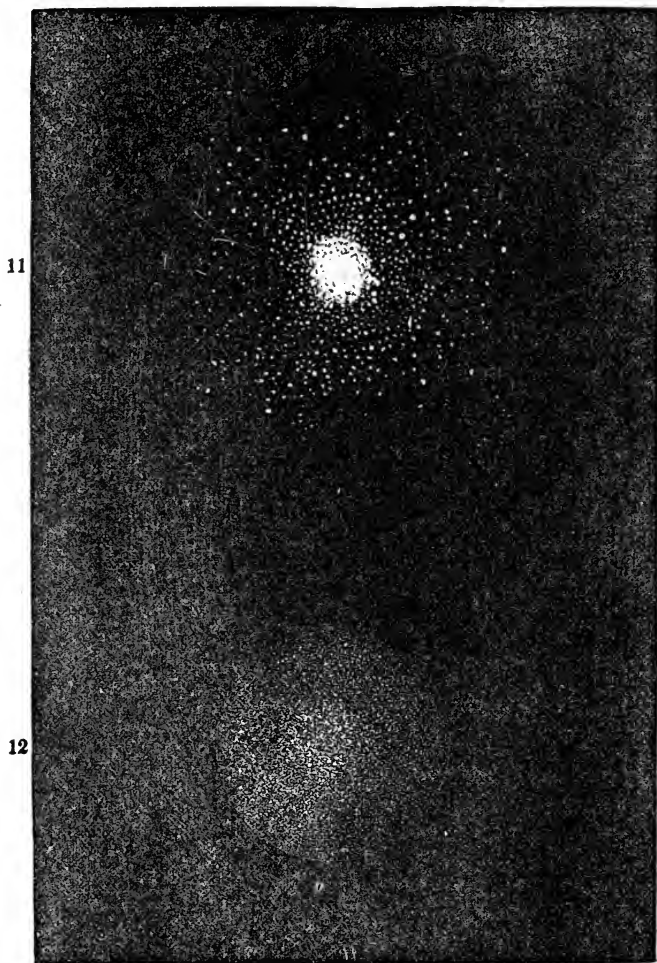

of large stars, into which the central cluster would be seen projected, and (owing to its greater distance) appearing, like it, to consist of stars much smaller than those in other parts of the heavens. Can it then be that we have here a real brother system, bearing a real physical resemblance and strong analogy of structure to our own? The elliptic form of the inner subdivided portion indicates with extreme probability an elevation of that portion above the plane of the rest, so that the real form must be that of a ring split through half its circumference, and having the split portions set asunder at about an angle of 45° each to the plane of the other."

A representation of this, as it might appear if seen as we see our own Milky Way in the direction of its plane, is given in fig. 11, by which its analogy to the Milky Way, will be rendered still more apparent.

In figures 11 and 12, are represented two nebulae, one of which belongs to the class which is distinctly resolvable into stars, and in which the condensation at the centre is so great that it becomes at that point a perfect blaze of

Fig. 13.



light. The other, fig. 12, is at a distance so much greater, that even to the most powerful instruments it presents only the appearance of a faint nebulous patch.

One of the most splendid objects of this class to be seen in the heavens, is the great nebula in the constellation of Orion. Let the eye be directed to the three well-known stars composing what is called the Belt. Immediately below these, and very nearly parallel to them in direction, will be seen three stars at nearly equal distances asunder, the two lower of the third and the upper of the fourth magnitude. If the middle star of these three be attentively viewed with the naked eye, the observer will find that it wants distinctness. It will be found to present a hazy appearance. If a common telescope be directed to it, it will be evidently perceived to be a nebula. In fine, the appearance it presents in a twenty-foot reflector is exhibited in the annexed drawing, fig. 13.

The following are the observations of Sir John Herschel upon this object:—

“I know not how to describe it better than by comparing it with a curdling liquid, or a surface strewed over with flocks of wool, or to the breaking up of a mackerel sky, when the clouds of which it consists begin to assume a cirrous appearance. It is not very unlike the mottling of the sun’s disk, only, if I may so express myself, the grain is much coarser and the intervals darker, and the flocculi, instead of being generally round, are drawn into little wisps. They present, however, an appearance of being composed of stars, and their aspect is altogether different from that of resolvable nebulae. In the latter we fancy by glimpses that we see stars, or that, could we strain our sight a little more, we would see them; but the former suggests no idea of stars, but rather of something quite distinct from them.”

Sir William Herschel, who had previously examined it, says:—

“In the year 1774, the 4th of March, I observed the nebulous star which is the 43d of the *Connaissance des Temps*, and is not many minutes north of the great nebula: but at the same time I also took notice of two similar, but much smaller nebulous stars, one on each side of the large one, and at nearly equal distances from it. In 1783 I examined the nebulous star, and found it to be faintly surrounded with a circular glory of whitish nebulosity, faintly joining it to the great nebula. About the latter end of that year I remarked that it was not equally surrounded, but most nebulous toward the south. In 1784 I began to entertain an opinion that the star was not connected with the nebulosity of the great nebula of Orion, but was one of those which are scattered over that part of the heavens. In 1801, 1806, and 1810, this opinion was fully confirmed by the gradual change which happened in that great nebula to which the nebulosity surrounding the star belongs; for the intensity of light about the nebulous star had by this time been considerably reduced by the attenuation or dissipation of the nebulous matter, and it seemed now to be pretty evident that the star is far behind the nebulous matter, and that, consequently, its light in passing through it is scattered and deflected so as to produce the appearance of a nebulous star.” “When I viewed this interesting object in December, 1810, I directed my attention particularly to the two nebulous stars by the sides of the large one, and found they were perfectly free from every nebulous appearance, which confirmed not only my former surmise of the great attenuation of the nebulosity, but also proved that their former nebulous appearance had been entirely the effect of the passage of their feeble light through the nebulous matter spread out before them. The 19th of January, 1811, I had another critical examination of the same object, in a very clear view, through the forty-foot telescope; but, notwithstanding the superior light of this instrument, I could not perceive any remains of nebulosity about

the two small stars, which were perfectly clear, and in the same situation where, about thirty-seven years before, I had seen them involved in nebulosity. If, then, the light of these three stars is thus proved to have undergone a visible modification in its passage through the nebulous matter, it follows that its situation among the stars is less distant from us than the largest of the three, which I suppose to be of the eighth or ninth magnitude. The farthest distance, therefore, at which we can place the faintest part of the great nebula in Orion, to which the nebulosity surrounding the star belongs, can not well exceed the region of the stars of the seventh or eighth magnitude."

Fig. 14.



In fig. 14, annexed, is represented a nebulous patch, differing in appearance from those already described. It is taken from a telescopic drawing made by Mr. Dunlop at Paramatta. Sir John Herschel, respecting these Megallanic clouds, as they are called, says:—

"The nubecula, major and minor, are very extraordinary objects The

greater is a congeries of clusters of irregular form, globular clusters, and nebulae of various magnitudes and degrees of condensation, among which is interspersed a large portion of irresolvable nebulae, which may be, and probably is *star-dust*, but which the power of the twenty-feet telescope shows only as a general illumination of the field of view, forming a bright ground on which other objects are scattered. Some of the objects in it are of very singular and incomprehensible forms; the chief one, especially (30 Doradus), which consists of a number of loops united in a kind of unclear centre or knot, like a bunch of ribands, disposed in what is called a *true-lover's knot*! There is no part of the heavens where so many nebulae and clusters are crowded into so small a space as this 'cloud.' The nubecula junior is a much less striking object. It abounds more in irresolvable nebulous light; but the nebulae and clusters in it are fewer and fainter, though immediately joining to it is one of the richest and most magnificent clusters in the hemisphere."

Fig. 15.



In some parts of the firmament appearances have been observed which have led to the conjecture that nebulous patches may be in a state of progressive formation into stellar clusters. An illustration of this is presented in fig. 15, annexed, in which a patch in the constellation of *Virgo* is represented. This portion of the heavens is strewn over with small round telescopic clusters, the stars of which seem to be closely condensed together.

"Planetary nebula," says Sir John Herschel, "are very extraordinary objects. They have, as their name imports, exactly the appearance of planets; round or slightly oval disks, in some instances quite sharply terminated, in others a little hazy at the borders, and of a light exactly equable or only a very little mottled, which, in some of them, approaches in vividness to that of actual planets. Whatever be their nature, they must be of enormous magnitude. One of them is to be found in the parallel of ν Aquarii, and about 5m. preceding that star. Its apparent diameter is about 20". Another, in the constellation Andromeda, presents a visible disk of 12", perfectly defined and round. Granting these objects to be equally distant from us with the stars, their real dimensions must be such as would fill, on the lowest computation, the whole orbit of Uranus. It is no less evident that, if they be solid bodies of a solar nature, the intrinsic splendor of their surfaces must be almost infinitely inferior to that of the sun's. A circular portion of the sun's disk, subtending an angle of 20", would give a light equal to 100 *full moons*; while the objects in question are hardly, if at all, discernable with the naked eye. The uniformity of their disks, and their want of apparent central condensation, would certainly augur their light to be merely superficial, and in the nature of a hollow spherical shell: but whether filled with solid or gaseous matter or altogether empty, it would be waste of time to conjecture.

"The nebulae furnish, in every point of view, an inexhaustible field of speculation and conjecture. That by far the larger share of them consist of stars there can be little doubt; and in the interminable range of system upon system, and firmament upon firmament, which we thus catch a glimpse of, the imagination is bewildered and lost. On the other hand, if it be true, as, to say the least, it seems extremely probable, that a phosphorescent or self-luminous matter also exists, disseminated through extensive regions of space, in the manner of a cloud or fog—now assuming capricious shapes, like actual clouds drifted by the wind, and now concentrating itself like a cometic atmosphere around particular stars: what, we naturally ask, are the nature and destination of this nebulous matter? Is it absorbed by the stars in whose neighborhood it is found, to furnish, by its condensation, their supply of light and heat? or is it progressively concentrating itself by the effect of its own gravity into masses, and so laying the foundation of new sidereal systems or of insulated stars? It is easier to propound such questions than to offer any probable reply to them. Meanwhile, appeal to fact, by the method of constant and diligent observation, is open to us; and, as the double stars have yielded to this style of questioning, and disclosed a series of relations of the most intelligible and interesting description, we may reasonably hope that the assiduous study of the nebulae will, ere long, lead to some clearer understanding of their intimate nature."

Having thus given examples of the principal varieties of form and condition exhibited by these objects, we may add that their number seems to be almost as unlimited as that of the stars, and that, like the stars, they are not equally distributed over every part of the firmament, but prevail most in particular regions of the heavens. The catalogue of nebulae published by Sir John Herschel in the *Philosophical Transactions* for 1833, contains a list of 2,306 nebulae visible from the observatory at Slough, which do not include the large

number since then observed during the residence of that astronomer at the cape of Good Hope. Although they are very irregularly scattered on the firmament, there seems to be some ground for concluding that they prevail chiefly in the direction of a great circle of the heavens inclined at a certain angle with the general direction of the Milky Way. The following passages from the memoirs of Sir William Herschel will better explain the manner in which they are distributed than any mere general description which could be given:—

“The nebulae are arranged into strata, and run on to a great length; and some of them I have been able to pursue, and to guess pretty well at their form and direction. It is probable enough that they may surround the whole starry sphere of the heavens, not unlike the Milky Way, which undoubtedly is nothing but a stratum of fixed stars. And as this latter immense starry bed is not of equal breadth or lustre in every part, nor runs on in one straight direction, but is curved and even divided into streams along a very considerable portion of it, we may likewise expect the greatest variety in the strata of the clusters of stars and nebulae. One of these nebulous beds is so rich, that in passing through a section of it, in the time of only thirty-six minutes, I have detected no less than thirty-one nebulae all distinctly visible upon a fine blue sky. Their situation and shape, as well as condition, seem to denote the greatest variety imaginable. In another stratum, or perhaps a different branch of the former, I have seen double and treble nebulae, variously arranged; large ones with small, seeming attendants; narrow, but much-extended lucid nebulae or bright dashes; some of the shape of a fan, resembling an electric brush issuing from a lucid point; others of the cometic shape, with a seeming nucleus in the centre, or like cloudy stars surrounded with a nebulous atmosphere. A different sort, again, contain a nebulosity of the milky kind, like that wonderful, inexplicable phenomenon about θ Orionis; while others shine with a fainter mottled kind of light, which denotes their being resolvable into stars.

“In my late observations on nebulae, I have found that I generally detected them in certain directions rather than in others; that the spaces preceding them were generally quite deprived of their stars, so as often to afford many fields without a single star in it; that the nebulae generally appeared some time after among stars of a certain considerable size, and but seldom among very small stars; and when I came to one nebula, I generally found several more in the neighborhood; that afterward a considerable time passed before I came to another parcel. These events being often repeated in different altitudes of my instrument, and some of them at considerable distances from each other, it occurred to me that the intermediate spaces between the sweeps might also contain nebulae; and finding this to hold good more than once, I ventured to give notice to my assistant at the clock that ‘I found myself on nebulous ground.’”

The conclusion, therefore, which follows from a general view of all the phenomena is, that the sun is an individual star of one great cluster, occupying a position near to, but not in its centre; that the stars of this cluster, seen in every direction around us, constitute the starry heavens as they are visible to us; that those which are placed nearest to the sun in the cluster, present to us the appearance of stars of the first magnitude, and that the others appear to be less and less bright and large as their distances are greater and greater; that the most remote and most numerous stars of the cluster are individually lost to the eye by their distance, but being confounded together like grains of powder thickly sprinkled on the general firmament, form the Milky Way; that this cluster of ours is not the only one of the kind in the universe, but that there are many thousands of others scattered through the depths of immensity; that those which are nearest to our own cluster can be seen by sufficiently

powerful telescopes so plainly that the individual stars which compose them can be distinguished, and these accordingly are called *resolvable nebulae*; that some more remote give doubtful appearances in the telescope, leaving the observer convinced that a little greater proximity of the object, or a little greater power of the telescope, would render the stars composing them distinctly visible; that others, still more remote, are at such enormous distances as to present no appearance, even to instruments of the greatest powers, except that of a faint nebulous patch; and finally, that every augmentation of the power of telescopes will resolve a greater number of these nebulae into distinct stars, and bring others which now can not be seen at all into view; and that this progression will go on without limit, the universe still expanding wider and more wide into the depths of infinite space, before the increasing power of science.

But is this all which can be inferred? That innumerable clusters may exist at such distances as only to appear as nebulous patches, even under the space-penetrating power of instruments so colossal as those of Sir William Herschel, and the more recent ones constructed by Lord Rosse, can not be disputed; but are *all nebulous* appearances of this character? Distance is indisputably a cause of nebular phenomena, but *is it the only cause?* This is a question which will require some discussion.

Sir William Herschel, who was the first to explain the phenomena of clusters and nebulae by the supposition of distinct and separate masses of stars removed to such a distance as to subtend a small visual angle, was also the first to raise a doubt whether this cause *alone* be sufficient to explain *all* the nebular phenomena. After long, patient, and minute surveys of the heavens, he was at last impressed with the belief that certain appearances indicated also the actual existence of luminous matter in situations comparatively near to us, and presenting the same or nearly the same appearance as masses of stars would whose distinctness would melt away in the magnitude of their distance. Among the phenomena which suggested this idea, the most prominent were those of nebulous stars. These objects appear as a bright stellar point, sometimes of the seventh or eighth magnitude, surrounded by a faintly luminous atmosphere of several minutes diameter. The star appears exactly in the centre, and the atmosphere around it perfectly circular in its outline is so diluted, faint, and equal throughout, as to suggest no idea of its consisting of stars. "If," says Sir William Herschel, "the nebulosity in this case consists of stars, appearing nebulous because of their distance which causes them to run into each other, what must be the size of the central body, which, at so enormous a distance, yet so far outshines all the rest? In the next place, if the central star be no bigger than common, how very small and compressed must be the other luminous points which send us only so faint a light? In the former case the central body would far exceed what we call a star; and in the latter, the shining matter about the centre would be too small to come under that designation. Either, then, we have a central body, which is not a star, or a star involved in a shining fluid of a nature wholly unknown to us."

There is one other supposition which will suggest itself. The central bright star may be immeasurably nearer to us than the cluster which, by its enormous distance, is reduced to a luminous haze, and may be projected upon it in the direction of the visual ray. Against this is to be advanced the improbability of such a casual projection, throwing the nearer star into the mathematical centre of the distant cluster. Such an accident might possibly occur in one or two instances, but we find it taking place in all cases of nebulous stars. In some parts of the heavens these stars appear in considerable numbers. Sir John Herschel mentions the nebulae surrounding the quadruple

or rather sextuple star θ in *Orion*, and the star η , in the constellation called *Robur Caroli*, as examples of nebulous appearances not easily explicable by the supposition of distant masses of stars. "The nebulous character of these objects," says he, "at least of the former, is very different from what might be supposed to arise from the congregation of an immense collection of small stars. It is formed of little flocky masses, like wisps of cloud; and such wisps seem to adhere to many small stars at its outskirts, and especially to one considerable star (represented, in the figure, below the nebula), which it envelopes with a nebulous atmosphere of considerable extent and singular figure. Several astronomers, on comparing this nebula with the figures of it handed down to us by its discoverer, Huygens, have concluded that its form has undergone a perceptible change. But when it is considered how difficult it is to represent such an object duly, and how entirely its appearance will differ, even in the same telescope, according to the clearness of the air, or other temporary causes, we shall readily admit that we have no evidence of change that can be relied on."

The impression of the necessity of admitting the existence of a subtle, self-luminous, nebulous fluid in the universe, gradually stole upon the mind of Sir William Herschel, and appears to be admitted by him with that reluctance which is felt when we are forced to admit something which a favorite hypothesis fails to explain.

"When I pursued these researches," says he, "I was in the situation of a natural philosopher who follows the various species of animals and insects from the height of their perfection down to the lowest ebb of life; when arriving at the vegetable kingdom, he can scarcely point out the precise boundary where the animal ceases and the plant begins, and may even go so far as to suspect them not to be essentially different. But recollecting himself, he compares, for instance, one of the human species with a tree, and all doubt upon the subject vanishes before him. In the same manner we pass by gentle steps from a coarse cluster down through others more remote, and therefore of finer texture, without any hesitation, till we find ourselves brought to an object such as the nebula in *Orion*, when we are still inclined to remain in our once adopted idea of stars exceedingly remote and inconceivably crowded, as being the occasion of that remarkable occurrence. It seems, therefore, to require a more dissimilar object to bring us right again. A glance like that of the naturalist, who casts his eye from the perfect vegetable to the perfect animal, is wanting to remove the veil from the mind of astronomers."

We must then conclude that appearances have been observed in the heavens which can not be satisfactorily explained by the supposition of distant masses of stars. The supposition of self-luminous nebulous matter, diffused in certain regions of the universe, has consequently been proposed as the only other mode of explaining them. That such matter, if it exist, is in the state or condition of vapor or fluid, is difficult to admit, since there appears more permanency about the nebular phenomena than could be easily reconciled with such a state. The most eminent mathematician and natural philosopher of the present century, has however adopted the supposition of a widely-diffused nebulosity, and has made it the basis of one of the boldest and most remarkable conjectures of modern times. Laplace has suggested that systems such as that of our sun and planets, might be conceived to be produced by the mere operation of mechanical laws out of such a nebular chaos! The gradual changes which this supposition compels us to admit must be imagined to be so slow, that in the whole duration of our experience or observation of the heavens they have not been perceptible. In other words, the period of time over which astronomical observation extends, is

but a moment in the growth of a system. The length of some astronomical periods, the reality of which is not disputed, is adduced to justify this. The planet *Herschel* or *Uranus*, has not yet completed a single period since its discovery; and several of the binary stars have been observed to move through only a small arc of their entire course. In the solar system many secular changes have been discovered, the completion of which will occupy many thousand years. Yet the reality of these is not the less certain. It is contended, therefore, that the gradual change of a nebula into a system, not having been actually seen, is no conclusive argument against its possible existence.

In the celebrated nebular hypothesis, which its illustrious author propounds as a mere conjecture, and with great diffidence it is supposed—that the sun has been formed by the gradual condensation and solidification of a mass of nebulous matter; that it revolved together with the nebulous atmosphere around it in the direction in which the planets now revolve, and which atmosphere, by the operation of an excessive degree of heat, extended to a distance from the common centre much greater than that of the most remote planet; that as this heat gradually diminished, the solar atmosphere contracted according to the common law of cooling bodies; that in accordance with the laws of revolving bodies, the velocity of its rotation increased; that an exterior zone of vapor was detached from the rest, where the centrifugal force produced by the central motion, exceeded the central attraction; that such zone of vapor might collect into a ring like those of Saturn; might aggregate into several masses revolving nearly in the same circle, like the new planets; or, finally, might coalesce into a single mass. Thus would be formed a number of planets which at first would be vapor. These planets would according to the laws of mechanics, have rotatory motions on their axes; these rotatory motions would be all in the same direction, and as the vapor would gradually cool down, each planet might form round its own centre satellites or rings, in the same manner as the planets themselves would be formed round the central sun.

This supposition will evidently explain the most obvious provisions of our system. If it did not, it would never have been proposed by its author. It is evident that all the principal motions of such a system would be nearly circular, and nearly in the plane of the original motion of rotation of the nebulous mass. It is easily proved also that the motions of the satellites round the planets respectively, and the motion of both planets and satellites on their axes would be in one common direction and one common plane. Thus it may be admitted that the most important laws on which the stability of the solar system depends would be explained.

But some modern writers on this subject have ascribed to this conjecture of a distinguished man a much more serious character than the author himself claimed for it. Laplace too well understood the rigorous canons of inductive philosophy to view his guesses as anything higher than an extremely refined and ingenious conjecture, certainly not deserving the name of a *theory*, and scarcely proper to be called even an *hypothesis*.

It is not worth while here to notice the innumerable arrangements which it fails to explain, arrangements certainly not less important than those which have been selected as the basis of the conjecture. But it may be well to warn those who are little familiar with such inquiries against the errors to which such an hypothesis might give birth. It is the general tendency of every ascent in the analysis of causation to give the appearance of superseding the supposition of an omnipotent agent above matter and its laws, the fountain of the intelligence, wisdom, design, and beneficence, manifested in the visible creation.

Yet the admission of the nebular hypothesis, were it conclusively established, would have no more real effect on the source of the wisdom of creation than the admission of the theory of gravitation. Every step we make in the generalization of the phenomena supplied by observation only transfers our view of the first cause one degree higher. In the present case we may ask with a distinguished contemporary, "how came the sun and its atmosphere to have such materials, such motions, such a constitution, that these beneficent consequences followed from their primordeal condition? How came the parent vapor, if vapor it were, to be thus capable of coherence, separation, contraction, solidification? How came the laws of its motion, attraction, repulsion, condensation, to be so fixed as to lead to a beautiful and harmonious system in the end? How came it to be neither too fluid nor too tenacious, to contract neither too quickly nor too slowly for the successive formation of the several planetary bodies? How came that substance which at one time was a luminous vapor to be at a subsequent period solids and fluids of many various kinds? What but design and intelligence prepared and tempered this variously-existing element, so that it should by its natural changes produce such an orderly system?"

And, we may further ask, to what else except intelligence and wisdom, prompted by beneficence, can be ascribed the fact that the source of light and heat should be placed in the central mass, while the detached revolving masses are deprived of this quality? or why is it that the apparatus for reflected light augments in power and efficiency as the planet to be supplied with light is more and more remote from the sun? and why is the distribution of land and water on the surface of the globe so admirably regulated? and whence has arisen the wonderful adaptation of the quantity and density of the air, and the mechanical and physical and chemical properties of that fluid to all the existing qualities and conditions of the world? These are manifestations of design, wisdom, goodness, and power, which are not reached or pretended to be reached, by any theory or hypothesis that the human mind has ever yet devised, save that only which we find in the character of the Most High, whether imparted by the voice of revelation or written on the face of nature

THE STEAM-ENGINE.

(FIRST LECTURE.)

The Steam-Engine a Subject of popular Interest.—Effects of Steam.—Great Power of Steam.—Mechanical Properties of Fluids.—Elastic and inelastic Fluids.—Elasticity of Gases.—Effects of Heat.—Savery's Engine.—Boilers and their Appendages.—Working Apparatus.—Mode of Operation.—Defects of Savery's Engine.—Newcomen and Cawley's Patent.—Accidental Discovery of Condensation by Injection.—Potter's Invention of the Method of working the Valves.—His Contrivance improved by the Substitution of the Plug-Frame.

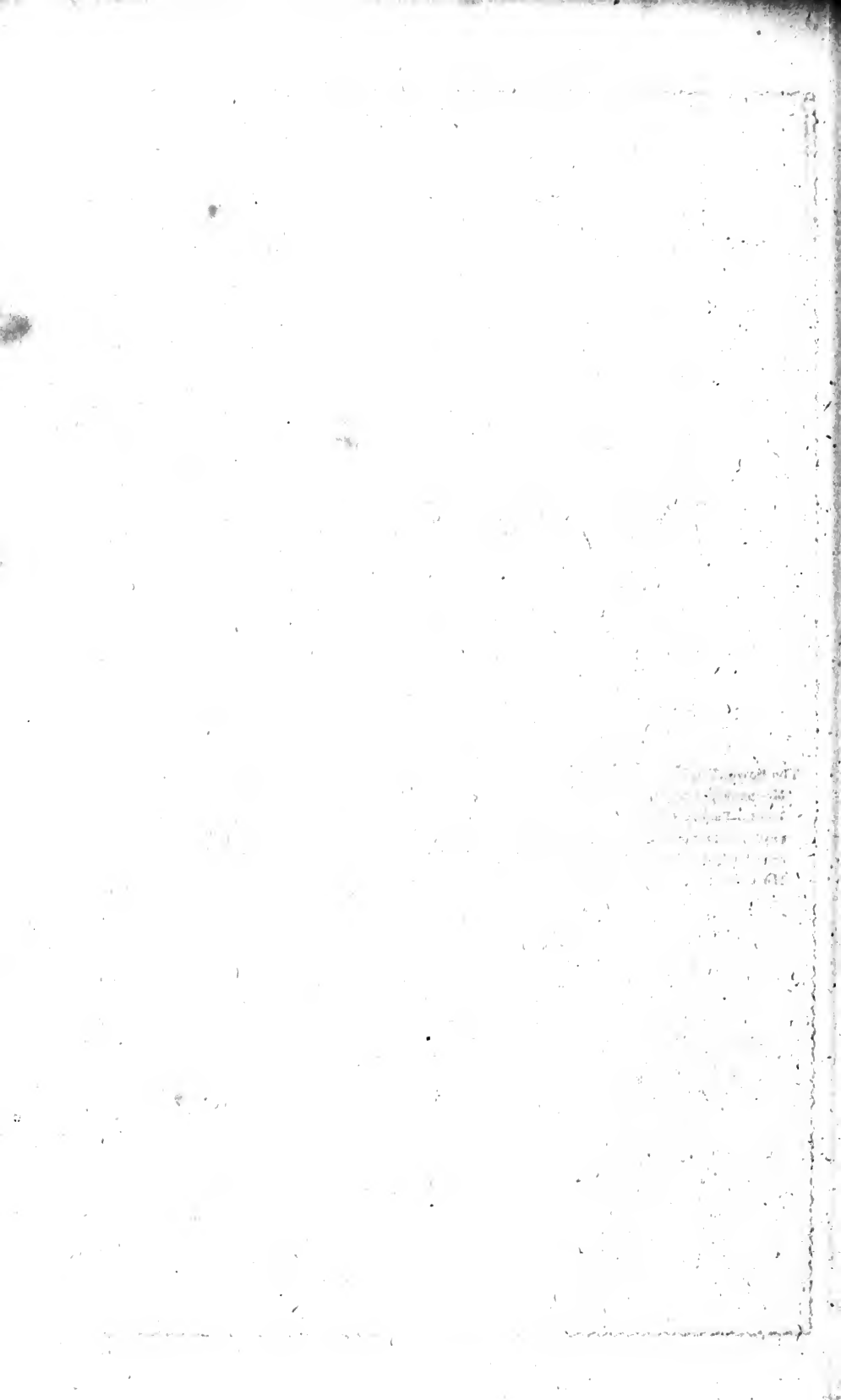

THE STEAM-ENGINE.

(FIRST LECTURE.)

THAT the history of the invention of a piece of mechanism, and the description of its structure, operation, and uses, should be capable of being rendered a subject-matter destined not alone for the instruction of engineers or machinists, but for the information and amusement of the public in general, is a statement which at a very remote period would have been deemed extravagant and incredible.

Advanced as we are in the art of rendering knowledge popular, and cultivated as the public taste is in the appreciation of the expedients by which science ministers to the uses of life, there is still perhaps but one machine of which such a proposition can be truly predicated: it is needless to say that that machine is the STEAM-ENGINE. There are many circumstances attending this extraordinary piece of mechanism which impart to it an interest so universally felt. Whether we regard the details of its structure and operation, the physical principles which it calls into play, and the beautiful contrivances by which these physical principles are rendered available: or, passing over these *means*, we direct our attention to the *ends* which they attain, we are equally filled with astonishment and admiration. The history of the steam-engine offers to our notice a series of contrivances which, for exquisite and refined ingenuity, stand without any parallel in the annals of mechanical science. These admirable inventions, unlike other results of scientific inquiry, have also this peculiarity, that, to understand their excellence and to perceive their beauty, no previous or subsidiary knowledge is necessary, save what may be imparted with facility and clearness in the progress of the explanation and development of the machine itself. A simple and clear exposition, divested of needless technicalities, and aided by well-selected diagrams, is all that is necessary to render the construction and operation of the steam-engine, in all its forms, intelligible to persons of plain understanding and moderate information.

But if the contrivances by which this vast power is brought to bear on the arts and manufactures, be rendered attractive by their great mechanical beauty, how much more imposing will the subject become when the effects which the steam-engine has produced upon the well-being of the human race are considered! It has penetrated the crust of the earth, and drawn from beneath it boundless treasures of mineral wealth, which, without its aid, would have been rendered inaccessible; it has drawn up, in measureless quantity, the fuel on which its own life and activity depend; it has relieved men from their most slavish toils, and reduced labor in a great degree to light and easy superintendence. To enumerate its present effects, would be to count almost every comfort and every luxury of life. It has increased the sum of human happiness, not only by calling new pleasures into existence, but by so cheapening former enjoyments as to render them attainable by those who before could never have hoped to share them: the surface of the land, and the face of the waters, are traversed with equal facility by its power; and by thus stimulating and facilitating the intercourse of nation with nation, and the commerce of people with people, it has knit together remote countries by bonds of amity not likely to be broken. Streams of knowledge and information are kept flowing between distant centres of population, those more advanced diffusing civilization and improvement among those that are more backward. The press itself, to which mankind owes in so large a degree the rapidity of their improvement in modern times, has had its power and influence increased in a manifold ratio by its union with the steam-engine. It is thus that literature is cheapened, and, by being cheapened, diffused; it is thus that reason has taken the place of force, and the pen has superseded the sword; it is thus that war has almost ceased upon the earth, and that the differences which inevitably arise between people and people are for the most part adjusted by peaceful negotiation.

The steam-engine is a mechanical contrivance, by which coal, wood, or other fuel, is rendered capable of executing any kind of labor. COALS are by it made to spin, weave, dye, print, and dress silks, cottons, woollens, and other cloths; to make paper, and print books upon it when made; to convert corn into flour; to express oil from the olive, and wine from the grape; to draw up metal from the bowels of the earth; to pound and smelt it, to melt and mould it; to forge it; to roll it, and to fashion it into every desirable form; to transport these manifold products of its own labor to the doors of those for whose convenience they are produced; to carry persons and goods over the waters of rivers, lakes, seas, and oceans, in opposition alike to the natural difficulties of wind and water; to carry the wind-bound ship out of port; to place her on the open deep ready to commence her voyage; to throw its arms around the ship-of-war, and place her side by side with the enemy; to transport over the surface of the deep persons and information, from town to town, and from country to country, with a speed as much exceeding that of the ordinary wind, as the ordinary wind exceeds that of a common pedestrian.

Such are the virtues, such the powers, which the steam-engine has conferred upon COALS. The means of calling these powers into activity are supplied by a substance which nature has happily provided in unbounded quantity in every part of the earth; and though it has no price, it has inestimable value: this substance is WATER.

A pint of water may be evaporated by two ounces of coals. In its evaporation it swells into two hundred and sixteen gallons of steam, with a mechanical force sufficient to raise a weight of thirty-seven tons a foot high. The steam thus produced has a pressure equal to that of common atmospheric air; and by allowing it to expand, by virtue of its elasticity, a further mechani-

cal force may be obtained, at least equal in amount to the former. A pint of water, therefore, and two ounces of common coal, are thus rendered capable of doing as much work as is equivalent to seventy-four tons raised a foot high.

The circumstances under which the steam-engine is worked on a railway are not favorable to the economy of fuel. Nevertheless a pound of coke burned in a locomotive-engine will evaporate about five pints of water. In their evaporation they will exert a mechanical force sufficient to draw two tons weight on the railway a distance of one mile in two minutes. Four horses working in a stage-coach on a common road are necessary to draw the same weight the same distance in six minutes.

A train of coaches weighing about eighty tons, and transporting two hundred and forty passengers with their luggage, has been taken from Liverpool to Birmingham, and back from Birmingham to Liverpool, the trip each way taking about four and a quarter hours, stoppages included. The distance between these places by the railway is ninety-five miles. This double journey of one hundred and ninety-miles is effected by the mechanical force produced in the combustion of four tons of coke, the value of which in England is about five pounds. To carry in England the same number of passengers daily between the same places by stage-coaches on a common road, would require twenty coaches and an establishment of three thousand eight hundred horses, with which the journey in each direction would be performed in about twelve hours, stoppages included.

The circumference of the earth measures twenty-five thousand miles; and if it were begirt with an iron railway, such a train as above described, carrying two hundred and forty passengers, would be drawn round it by the combustion of about thirty tons of coke, and the circuit would be accomplished in five weeks.

In the drainage of the Cornish mines the economy of fuel is much attended to, and coals are there made to do more work than elsewhere. A bushel of coals usually raises forty thousand tons of water a foot high; but it has on some occasions raised sixty thousand tons the same height. Let us take its labor at fifty thousand tons raised one foot high. A horse worked in a fast stage-coach pulls against an average resistance of about a quarter of a hundred weight. Against this he is able to work at the usual speed through about eight miles daily; his work is therefore equivalent to about five hundred tons raised one foot. A bushel of coals, consequently, as used in Cornwall, performs as much labor as a day's work of one hundred such horses.

The great pyramid of Egypt stands upon a base measuring seven hundred feet each way, and is five hundred feet high, its weight being twelve thousand, seven hundred and sixty millions of pounds. Herodotus, states, that, in constructing it, one hundred thousand men were constantly employed for twenty years. The materials of this pyramid would be raised from the ground to their present position by the combustion of about four hundred and eighty tons of coals.

The Menai bridge consists of about two thousand tons of iron, and its height above the level of the water is one hundred and twenty feet. Its mass might be lifted from the level of the water to its present position by the combustion of four bushels of coals.

The enormous consumption of coals produced by the application of the steam-engine in the arts and manufactures, as well as to railways and navigation, has of late years excited the fears of many as to the possibility of the exhaustion of our coal-mines. Such apprehensions are, however, altogether groundless. If the present consumption of coal be estimated at twenty millions

of tons annually, it is demonstrable that the coal-fields of England and the United States would not be exhausted for many centuries.

But in speculations like these, the probable if not certain progress of improvement and discovery ought not to be overlooked; and we may safely pronounce that, long before such a period of time shall have rolled away, other and more powerful mechanical agents will supersede the use of coal. Philosophy already directs her finger at sources of inexhaustible power in the phenomena of electricity and magnetism. The alternate decomposition and recomposition of water, by magnetism and electricity, has too close an analogy to the alternate processes of vaporization and condensation, not to occur at once to every mind: the development of the gases from solid matter by the operation of the chemical affinities, and their subsequent condensation into the liquid form, has already been essayed as a source of power. In a word, the general state of physical science at the present moment, the vigor, activity, and sagacity, with which researches in it are prosecuted in every civilized country, the increasing consideration in which scientific men are held, and the personal honors and rewards which begin to be conferred upon them, all justify the expectation that we are on the eve of mechanical discoveries still greater than any which have yet appeared; and that the steam-engine itself, with the gigantic powers conferred upon it, will dwindle into insignificance in comparison with the energies of nature which are still to be revealed; and that the day will come when that machine, which is now extending the blessings of civilization to the most remote skirts of the globe, will cease to have existence except in the page of history.

In explaining the different forms of steam-engine which have been proposed in the course of the progressive improvement of that machine from its early rude and imperfect state to its present comparatively perfect form, it will be necessary to advert to physical phenomena and mechanical principles, which, however obvious to those who are conversant with matters of science, must necessarily be at least imperfectly known by the great majority. To refer for information on such topics to other works on mechanics and general physics, would be with most readers ineffectual, and with all unsatisfactory. We shall therefore pause as we proceed, where these difficulties occur, to give such explanation and illustration as may seem best suited to render them intelligible and interesting to the unscientific reader.

Fluid bodies are of two kinds—inelastic fluids, or liquids, and elastic fluids, or gases. Of the former of these classes, water is the most familiar example; and of the latter, air.

These two species of fluids are each distinguished by peculiar mechanical properties.

The constituent particles of a liquid are distinguished from those of solids by having little or no coherence; so that unless the mass be confined by the sides of the vessel which contains it, the particles will fall asunder by their gravity. A mass of liquid, therefore, unlike a solid, can never retain any particular form, but will accommodate itself to the form of the vessel in which it is placed. It will press against the bottom of the vessel which contains it with the whole force of its weight, and it will press against the sides with a force proportional to the depth of the particles in contact with the sides measured from the surface of the liquid above. This lateral pressure also distinguishes liquids from solids. Let us take for illustration the case of a square or a cubical vessel, *A B C D*, fig. 1. If a solid body, such as a piece of lead, be cut to the shape of this vessel, so as to fit in it without pressing with any force against its sides, the mechanical effect which would be produced by it when placed in the vessel, would be merely a pressure upon the bottom *B C*,

Fig. 1.

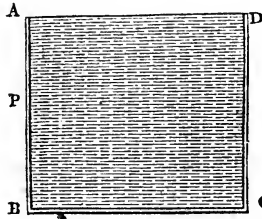

the amount of which would be equal to the weight of the metallic mass. No pressure would be exerted against the sides; for the coherence of the particles of the solid maintaining them in their position, the removal of the sides would not subject the solid body contained in the vessel to any change.

Now let us suppose this solid mass of lead to be rendered liquid by being melted. The constituent particles will then be deprived of that cohesion by which they were held together; they will accordingly have a tendency to separate, and fall asunder by their gravity, and will only be prevented from actually doing so by the support afforded to them by the sides, A B, D C, of the vessel. They will therefore produce a pressure against the sides, which was not produced by the lead in its solid state. This pressure will vary at different depths: thus a part of the side of the vessel at P will receive a pressure proportional to the depth of the point P below the surface of the lead. If, for example, we take a square inch of the inner surface of the side of the vessel at P, it will sustain an outward pressure equal to the weight of a column of lead having a square inch for its base, and a height equal to P A. And, in like manner, every square inch of the sides of the vessel will sustain an outward pressure equal to the weight of a column of lead having a square inch for its base, and a height equal to the depth of the point below the surface of the lead.

We have here proceeded upon the supposition that no force acts on the upper surface, A D, of the lead. If any force presses A D downward, that force would be transferred to the bottom by the lead, and would produce a pressure on the bottom B C, equal to its own amount, in addition to the weight of the lead; and if the lead were solid, this would be the only additional mechanical effect which such a force acting on the surface, A D, of the lead would produce. But if, on the other hand, the lead were liquefied, then the force now adverted to, acting on the surface, A D, would not only produce a pressure on the bottom B C, equal to its own amount in addition to the weight of the lead, but it would also produce a pressure against every part of the sides of the vessel, equal to that which it would produce upon an equal magnitude of the surface A D.

Thus, if we suppose any mechanical cause producing a pressure on the surface A D amounting to ten pounds on each square inch, the effect which would be produced, if the lead were solid, would be an additional pressure on the base B C amounting to ten pounds per square inch. But if the lead were liquid, besides this pressure on each square inch of the base B C, there would likewise be a pressure of ten pounds on every square inch of the sides of the vessel.

All that has been here stated with respect to a square or a cubical vessel, will be equally applicable to a vessel of any other form.

The second class of fluids are distinguished from liquids by the particles not merely being destitute of cohesion, but having a tendency directly the reverse, to repel each other, and fly asunder with more or less force. Thus,

if a vessel, such as that represented in fig. 1, were filled with a fluid of this kind, being open at the top, and not being restrained by any pressure incumbent upon it, the particles of the fluid would not rest in the vessel by their gravity, as those of the liquid would do; but they would, by their mutual repulsion, fly asunder, and rise out of the vessel, as smoke is seen to rise from a chimney, or steam from the spout of a kettle. Let us suppose, then, that the vessel in which an elastic fluid is contained is closed on every side by solid surfaces. In fact, let us imagine that the square or cubical vessel represented in fig. 1 is closed by a square lid at the top, A D, having contained in it an elastic fluid, such as atmospheric air.

If such a cover, or lid, had been placed upon a liquid, the cover would sustain no pressure from the fluid, nor would any mechanical effect be produced, save those already described in the case of the open vessel; but when the fluid contained in the vessel is elastic, as is the case with air, then the elasticity (by which name is expressed the tendency of the particles of the fluid to fly asunder) will produce peculiar mechanical effects, which have no existence whatever in the case of a liquid.

It is true that, supposing the fluid to be air or any other gas or vapor, a pressure will be produced upon the bottom, B C, of the vessel equivalent to the weight of such fluid, and lateral pressures will be produced on the different points of the sides by the weight of that part of the fluid which is above these points; but gases and vapors are bodies of such extreme levity, that these effects due to their weight are neglected in practice.

Putting, then, the weight of the air contained in the vessel out of the question, let us consider the effect of its elasticity. If the vessel, as already described, be supposed to contain atmospheric air in its ordinary state, the tendency of the constituent particles to fly asunder will be such as to produce on every square inch of the inner surface of the vessel a pressure amounting to fifteen pounds; this pressure being, as already stated, quite independent of the weight of the air. In fact, this pressure would continue to exist if the air contained in the vessel actually ceased to have weight by being removed from the neighborhood of the earth, which is the cause of its gravity.

Different gases are endowed with different degrees of elasticity, and the same gas may have its elasticity increased or diminished, either by varying the space within which it is confined, or by altering the temperature to which it is exposed.

If the space within which an elastic fluid is enclosed be enlarged, its elasticity is found to diminish in the same proportion. Thus, if the air contained in the vessel A B C D (fig. 1) be allowed to pass into a vessel of twice the magnitude, the elasticity of the particles will cause them to repel each other, so that the same quantity of air shall diffuse itself throughout the larger vessel, assuming double its former bulk. Under such circumstances, the pressure which it would exert upon the sides of the larger vessel would be only half that which it had exerted on the sides of the smaller vessel. If, on the other hand, it were forced into a vessel of half the magnitude of A B C D, as it might be, then its elasticity would be double, and it would press on the inner surface of that vessel with twice the force with which it pressed on that of the vessel A B C D.

This power of swelling and contracting its dimensions according to the dimensions of the vessel in which it is confined, or to the force compressing it, is a quality which results immediately from elasticity, and is consequently one which is peculiar to the gases or elastic fluids, and does not at all appertain to liquids. If the liquid contained in the vessel A B C D were transferred to a vessel of twice the magnitude, it would only occupy half the ca-

capacity of that vessel, and it could not by any means be transferred, as we have supposed the air or gas to be, to a vessel of half the dimensions, since it is inelastic and incompressible.

The elasticity of gases is likewise varied by varying the temperature to which they are exposed; thus, in general, if air or any other gas be augmented in temperature, it will likewise be increased in elasticity; and if, on the other hand, it be diminished in temperature, it will be likewise diminished in its elastic force. The more heated, therefore, any air or gas confined in a vessel becomes, the greater will be the force with which it will press on the inner surface of that vessel, and tend to burst it.

The same body may, by the agency of heat, be made to pass successively through the different states of solid, liquid, and gas or vapor. The most familiar and obvious example of these successive transitions is presented by water. Exposed to a certain temperature, water can only exist as a solid; as the temperature is increased, the ice, or solid water, is liquefied; and by the continued application of heat, this water again undergoes a change, and assumes the form, and acquires the mechanical qualities, of air or gas: in such a state it is called STEAM.

This is a common property of all liquids. If they be exposed for a sufficient length of time to a sufficient degree of heat, they will always be converted into elastic fluids. These are usually distinguished from air and other permanent gases, which never are known to exist in the liquid form, by the term *vapor*, by which, therefore, must be understood an elastic fluid which at common temperatures exists in the liquid or solid state; by *steam* is expressed the vapor of water; and by *gases*, those elastic fluids which, like air, are never known—at least, under ordinary circumstances—to exist in any other but the elastic form.

When a liquid is caused, by the application of heat, to take the form of an elastic fluid, or is evaporated, besides acquiring the property of elasticity, it always undergoes a considerable change of bulk. The amount of this change is different with different liquids, and even with the same liquid it varies with the circumstances under which the change is produced.

When water is evaporated under ordinary circumstances—that is, when exposed to no other external pressure than that of the atmosphere—it increases its volume about seventeen-hundred-fold. Thus a cubic inch of liquid water would form about seventeen hundred cubic inches of common steam. If, however, the water be confined by a greater pressure than that produced by the common atmosphere, then the increase of volume which takes place in its evaporation would be less in proportion.

The steam-engine contrived by Savery in the year 1698, like every other which has since been constructed, consists of two parts, essentially distinct. The first is that which is employed to generate the steam, which is called the boiler; and the second, that in which the steam is applied as a moving power.

The former apparatus in Savery's engine consists of two strong boilers, sections of which are represented at D and E in fig. 2; D the greater boiler, and E the less. The tubes T and T' communicate with the working apparatus, which we shall presently describe. A thin plate of metal, R, is applied closely to the top of the great boiler D, turning on a centre C, so that by moving a lever applied to the axis C on the outside of the top, the sliding plate R can be brought from the mouth of the one tube to the mouth of the other alternately. This sliding-valve is called the *regulator*, since it is by it that the communications between the boiler and two steam-vessels (hereafter described) are alternately opened and closed, the lever which effects this being moved at intervals by the hand of the attendant.

Fig. 2.

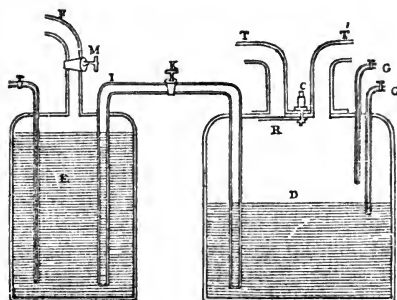

Two *gauge-cocks* are represented at G G', the use of which is to determine the depth of water in the boiler. One, G, has its lower aperture a little above the proper depth; and the other, G', a little below it. Cocks are attached to the upper ends G G', which can be opened or closed at pleasure. The steam collected in the top of the boiler pressing on the surface of the water, forces it up in the tubes G G', if their lower ends be immersed. Upon opening the cocks G G', if water be forced from both, there is too much water in the boiler, since the mouth of G is *below* its level. If steam issue from both, there is too little water in the boiler, since the mouth of G' is *above* its level. But if steam issue from G, and water from G', the water in the boiler is at its proper level. This ingenious contrivance for determining the level of the water in the boiler is the invention of Savery, and is used in many instances at the present day.

The mouth of the pipe G should be at a level of a little less than one third of the whole depth, and the mouth of G' at a level little lower than one third, for it is requisite that about two thirds of the boiler should be kept filled with water. The tube I forms a communication between the greater boiler D and the lesser or feeding boiler E, descending nearly to the bottom of it. This communication can be opened and closed at pleasure by the cock K. A gauge pipe is inserted similar to G G', but extending nearly to the bottom. From this boiler a tube, F, extends, which is continued to a cistern, C (fig. 3), and a cock is placed at M, which, when opened, allows the water from the cistern to flow into the feeding boiler E, and which is closed when that boiler is filled. The manner in which this cistern is supplied will be described hereafter.

Let us now suppose that the principal boiler is filled to the level between the gauge-pipes, and that the subsidiary boiler is nearly full of water, the cock K and the gauge-cocks G G' being all closed. The fire being lighted beneath D, and the water boiled, steam is produced, and is transmitted through one or other of the tubes T T', to the working apparatus. When evaporation has reduced the water in D below the level of G, it will be necessary to replenish the boiler D. This is effected thus:—A fire being lighted beneath the feeding-boiler E, steam is produced in it above the surface of the water, which, having no escape, presses on the surface so as to force it up in the pipe I. The cock K being then opened, the boiling water is forced into the principal boiler D, into which it is allowed to flow until water issues from the gauge-cock G'. When this takes place, the cock K is closed, and the fire removed from E until the great boiler again wants replenishing. When the feeding-boiler E has been exhausted, it is replenished from the cistern C (fig. 3), through the pipe F, by opening the cock M.

We shall now describe the working apparatus in which the steam is used as a moving power.

Let $V V'$ (fig. 3) be two steam-vessels, communicating by the tubes $T T'$ (marked by the same letters in fig. 2) with the greater boiler D .

Let S be a pipe, called the *suction-pipe*, descending into the well or reservoir from which the water is to be raised, and communicating with each of

Fig. 3.

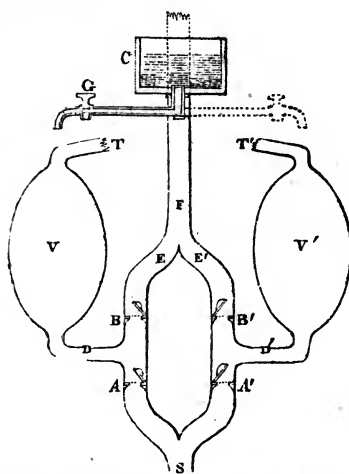

the steam-vessels through tubes $D D'$, by valves $A A'$, which open upward. Let F be a pipe continued from the level of the engine to whatever higher level it is intended to elevate the water. The steam-vessels $V V'$ communicate with the *force-pipe* F , by valves $B B'$, which open upward, through the tubes $E E'$. Over the steam-vessels and on the force-pipe is placed a small cistern, C , already mentioned, which is kept filled with cold water from the force-pipe, and from the bottom of which proceeds a pipe terminated with a cock G . This is called the *condensing-pipe*, and can be brought alternately over each steam-vessel. From this cistern another pipe communicates with the feeding-boiler (fig. 2) by the cock M .

The communication of the pipes $T T'$ with the boiler can be opened and closed alternately, by the regulator R (fig. 2), already described.

Now, suppose the steam-vessels and tubes to be all filled with common atmospheric air, and that the regulator be placed so that the communication between the tube T and the boiler be opened, the communication between the other tube T' and the boiler being closed, steam will flow into V through T . At first, while the vessel V is cold, the steam will be condensed, and will fall in drops of water on the bottom and sides of the vessel. The continued supply of steam from the boiler will at length impart such a degree of heat to the vessel V , that it will cease to condense it. Mixed with the heated air contained in the vessel V , it will have an elastic force greater than the atmospheric pressure, and will therefore force open the valve B , through which a mixture of air and steam will be driven until all the air in the vessel V will have passed out, and it will contain nothing but the pure vapor of water.

When this has taken place, suppose the regulator be moved so as to close the communication between the tube T and the boiler, and to stop the further supply of steam to the vessel V ; and at the same time let the condensing-pipe G be brought over the vessel V , and the cock opened so as to let a stream of cold water flow upon it. This will cool the vessel V , and the steam with which it is filled will be condensed and fall in a few drops of water, leaving

the interior of the vessel a vacuum. The valve B will be kept closed by the atmospheric pressure. But the elastic force of the air between the valve A and the surface of the water in the well, or reservoir, will open A, so that a part of this air will rush in and occupy the vessel V. The air in the suction-pipe S, being thus allowed an increased space, will be proportionably diminished in its elastic force, and its pressure will no longer balance that of the atmosphere acting on the external surface of the water in the reservoir. This pressure will therefore force water up in the tube S, until its weight, together with the elastic force of the air above it, balances the atmospheric pressure. When this has taken place, the water will cease to ascend.

Let us now suppose, that, by shifting the regulator, the communication is opened between T and the boiler, so that steam flows again into V. The condensing-cock G being removed, the vessel will be again heated as before, the air expelled, and its place filled by the steam. The condensing-pipe being again allowed to play upon the vessel V, and the further supply of steam being stopped, a vacuum will be produced in V, and the atmospheric pressure will force the water through the valve A into the vessel V, which it will nearly fill, a small quantity of air, however, remaining above it.

Thus far the mechanical agency employed in elevating the water is the atmospheric pressure, and the power of steam is no further employed than in the production of a vacuum. But, in order to continue the elevation of the water through the force-pipe F, above the level of the steam-vessel, it will be necessary to use the elastic pressure of the steam. The vessel V is now nearly filled by the water which has been forced into it by the atmosphere. Let us suppose, that, the regulator being shifted again, the communication between the tube T and the boiler is opened, the condensing-cock removed, and that steam flows into V. At first, coming in contact with the cold surface of the water and that of the vessel, it is condensed; but the vessel is soon heated, and the water formed by the condensed steam collects in a sheet or film upon the surface of the water in V, so as to form a surface as hot as boiling water.* The steam then being no longer condensed, presses on the surface of the water with its elastic force; and when that pressure becomes greater than the atmospheric pressure, the valve B is forced open, and the water issuing through it, passes through E into the force-pipe F; and this is continued until the steam has forced all the water from V and occupies its place.

The further admission of steam through T is once more stopped by moving the regulator, and the condensing-pipe being again allowed to play on V, so as to condense the steam which fills it, produces a vacuum. Into this vacuum, as before, the atmospheric pressure will force the water and fill the vessel V. The condensing-pipe being then closed, and steam admitted through T, the water in V will be forced by its pressure through the valve B and tube E into F, and so the process is continued.

We have not yet noticed the other steam vessel V', which, as far as we have described, would have remained filled with common atmospheric air, the pressure of which on the valve A' would have prevented the water raised in the suction-pipe S from passing through it. However, this is not the case; for, during the entire process which has been described in V, similar effects have been produced in V', which we have only omitted to notice to avoid the confusion which the two processes might produce. It will be remembered, that after the steam, in the first instance, having flowed from the boiler through T, has blown the air out of V through B, the communication between T and the boiler is closed. Now, the same motion of the regulator which closes this, opens the communication between T' and the boiler; for the sliding-

* Hot water, being lighter than cold, floats on the surface.

plate R (fig. 2) is moved from the one tube to the other, and at the same time, as we have already stated, the condensing-pipe is brought to play on V. While, therefore, a vacuum is being formed in V by condensation, the steam, flowing through T', blows out the air through B', as already described in the other vessel V; and while the air in S is rushing up through A into V, followed by the water raised in S' by the atmospheric pressure, the vessel V' is being filled with steam, and the air is completely expelled from it.

The communication between T and the boiler is now again opened, and the communication between T' and the boiler closed by moving the regulator R (fig. 2) from the tube T to T'; at the same time the condensing pipe is removed from over V, and brought to play upon V'. While the steam once more expels the air from V through B, a vacuum is formed by condensation in V', into which the water in S rushes through the valve A'. In the meantime V is again filled with steam. The communication between T and the boiler is now closed, and that between T' and the boiler is opened, and the condensing pipe removed from V', and brought to play on V. While the steam from the boiler forces the water in V' through B' into the force-pipe F, a vacuum is being produced in V, into which water is raised by the atmospheric pressure.

Thus each of the vessels V V' is alternately filled from S, and the water thence forced into F. The same steam which forces the water from the vessels into F, having done its duty, is condensed, and brings up the water from S, by giving effect to the atmospheric pressure.

During this process, two alternate motions or adjustments must be constantly made; the communication between T and the boiler must be opened, and that between T' and the boiler closed, which is done by one motion of the regulator. The condensing pipe at the same time must be brought from V to play on V', which is done by the lever placed upon it. Again the communication between T' and the boiler is to be opened, and that between T and the boiler closed; this is done by moving back the regulator. The condensing-pipe is brought from V' to V by moving back the other lever, and so on alternately.

In order duly to appreciate the value of improvements, it is necessary first to perceive the defects which these improvements are designed to remove. Savery's steam-engine, considering how little was known of the value and properties of steam, and how low the general standard of mechanical knowledge was in his day, is certainly highly creditable to his genius. Nevertheless it had very considerable defects, and was finally found to be inefficient for the most important purposes to which he proposed applying it.

At the time of this invention, the mines in England had greatly increased in depth, and the process of draining them had become both expensive and difficult; so much so, that it was found in many instances that their produce did not cover the cost of working them. The drainage of these mines was the most important purpose to which Savery proposed to apply his steam-engine.

It has been already stated that the pressure of the atmosphere amounts to about fifteen pounds on every square inch. Now, a column of water, whose base is one square inch, and whose height is thirty-four feet, weighs about fifteen pounds. If we suppose that a perfect vacuum were produced in the steam-vessels V V' (fig. 3), by condensation, the atmospheric pressure would fail to force up the water, if the height of the top of these vessels above the water to be raised exceeded thirty-four feet. It is plain, therefore, that the engine cannot be more than thirty-four feet above the water which it is intended to elevate. But in fact it cannot be so much; for the vacuum produced in the steam-vessels V V' is never perfect. Water, when not submitted to the pressure of the atmosphere, will vaporize at a very low temperature, as we shall hereafter explain; and it was found that a vapor possessing a considera-

ble elasticity would, notwithstanding the condensation, remain in the vessels $V V'$ and the pipe S , and would oppose the ascent of the water. In consequence of this, the engine could never be placed, with practical advantage, at a greater height than twenty-six feet above the level of the water to be raised.

When the water is elevated to the engine, and the steam-vessels filled, if steam be introduced above the water in V , it must first balance the atmospheric pressure, before it can force the water through the valve B . Here, then, is a mechanical pressure of fifteen pounds per square inch expended, without any water being raised by it. If steam of twice that elastic force be used, it will elevate a column in F of thirty-four feet in height; and if steam of triple the force be used, it will raise a column of sixty-eight feet high, which, added to twenty-six feet raised by the atmosphere, gives a total lift of ninety-four feet.

In effecting this, steam of a pressure equal to three times that of the atmosphere acts on the inner surface of the vessels $V V'$. One third of this bursting pressure is balanced by the pressure of the atmosphere on the external surface of the vessels; but an effective pressure of thirty pounds per square inch still remains, tending to burst the vessels. It was found that the apparatus could not be constructed to bear more than this with safety; and, therefore, in practice, the lift of such an engine was limited to about ninety perpendicular feet. In order to raise the water from the bottom of the mine by these engines, therefore, it was necessary to place one at every ninety feet of the depth; so that the water raised by one through the first ninety feet should be received in a reservoir, from which it was to be elevated the next ninety feet by another, and so on.

Beside this, it was found that sufficient strength could not be given to those engines, if constructed upon a large scale.

They were, therefore, necessarily very limited in their dimensions, and were incapable of raising the water with sufficient speed. Hence arose a necessity for several engines at each level, which greatly increased the expense.

These, however, were not the only defects of Savery's engines. The consumption of fuel was enormous; the proportion of heat wasted being much more than what was used in either forcing up the water, or producing a vacuum. This will be very easily understood, by attending to the process of working the engine already described.

When the steam is first introduced from the boiler into the steam-vessels $V V'$, preparatory to the formation of a vacuum, it is necessary that it should heat these vessels up to the temperature of the steam itself; for until then the steam will be condensed the moment it enters the vessel, by the cold surface. All this heat, therefore, spent in raising the temperature of the steam-vessels is wasted. Again, when the water has ascended and filled the vessels $V V'$, and steam is introduced to force this water through $B B'$ into F , it is immediately condensed by the cold surface in $V V'$, and does not begin to act until a quantity of hot water, formed by condensed steam, is collected on the surface of the cold water which fills these vessels. Hence another source of the waste of heat arises.

When the steam begins to act upon the surface of the water in $V V'$, and to force it down, the cold surface of the vessels is gradually exposed to the steam, and must be heated while the steam continues its action; and when the water has been forced out of the vessel, the vessel itself has been heated to the temperature of the steam which fills it, all which heat is dissipated by the subsequent process of condensation. It must thus be evident, that the steam used in forcing up the water in F , and in producing a vacuum, bears a very small proportion, indeed, to what is consumed in heating the apparatus after condensation.

There is also another circumstance which increases the consumption of fuel. The water must be forced through B, not only against the atmospheric pressure, but also against a column of sixty-eight feet of water. Steam is therefore required of a pressure of forty-five pounds on the square inch. Consequently the water in the boiler must be boiled under this pressure. That this should take place, it is necessary that the water should be raised to a temperature considerably above 212° , even so high as 275° ; and thus an increased heat must be given to the boiler. Independently of the other defects, this intense heat weakened and gradually destroyed the apparatus.

Savery was the first who suggested the method of expressing the power of an engine with reference to that of horses. In this comparison, however, he supposed each horse to work but eight hours a day, while the engine works for twenty-four hours. This method of expressing the power of steam-engines will be explained hereafter.

The failure of the engines proposed by Captain Savery in the work of drainage, from the causes which have been just mentioned, and the increasing necessity for effecting this object, arising from the large property in mines which became every year unproductive by being flooded, stimulated the ingenuity of mechanics to contrive some means of rendering those powers of steam exhibited in Savery's engine available.

Thomas Newcomen, the reputed inventor of the atmospheric engine, was an ironmonger, or, according to some, a blacksmith, in the town of Dartmouth, in Devonshire. From his personal acquaintance and intercourse with Dr. Hooke, the celebrated natural philosopher, it is probable that he was a person of some education, and therefore likely to be above the position of a blacksmith. Being in the habit of visiting the tin mines in Cornwall, Newcomen became acquainted with the engine invented by Savery, and with the causes which led to its inefficiency for the purposes of drainage.

John Cawley, who was the associate of Newcomen in his experiments and inquiries, was a plumber and glazier of the same town. Newcomen and Cawley obtained a patent for the atmospheric engine, in 1705, in which Savery was associated, he having previously obtained a patent for the method of producing a vacuum by the condensation of steam, which was essential to Newcomen's contrivance. It was not, however, until about the year 1711, that any engine had been constructed under this patent.

Newcomen resumed the old method of raising the water from the mines by ordinary pumps, but conceived the idea of working these pumps by some moving power less expensive than that of horses. The means whereby he proposed effecting this, was by connecting the end of the pump-rod D (fig. 4) by a chain with the arch-head A of a working-beam A B, playing on an axis C. The other arch-head B of this beam was connected by a chain with the rod E of a solid piston P, which moved air-tight in a cylinder F. If a vacuum be created beneath the piston P, the atmospheric pressure acting upon it will press it down with a force of fifteen pounds per square inch; and the end A of the beam being thus raised, the pump-rod D will be drawn up. If a pressure equivalent to the atmosphere be then introduced below the piston, so as to neutralize the downward pressure, the piston will be in a state of indifference as to the rising or falling; and if in this case the rod D be made heavier than the piston and its rod, so as to overcome the friction, it will descend, and elevate the piston again to the top of the cylinder. The vacuum being again produced, another descent of the piston, and consequent elevation of the pump-rod, will take place; and so the process may be continued.

Such was Newcomen's first conception of the *atmospheric engine*; and the contrivance had much, even at the first view, to recommend it. The power of

Fig. 4.

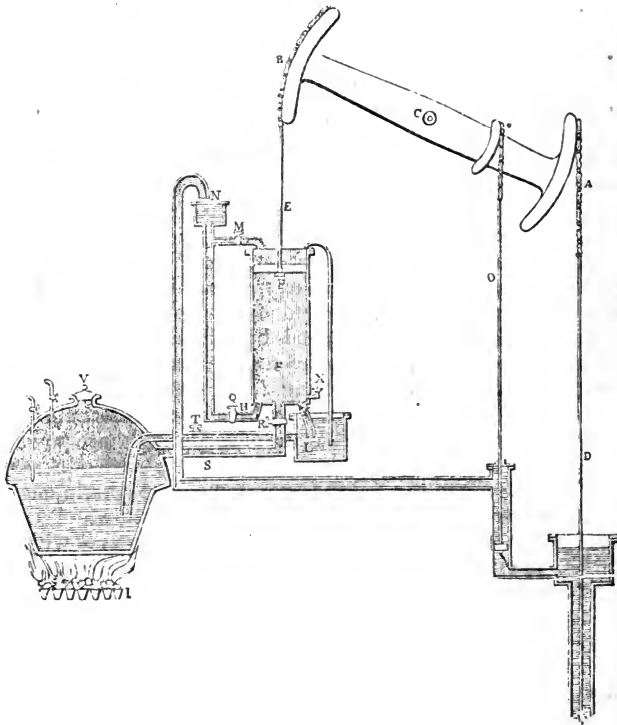

such a machine would depend entirely on the magnitude of the piston; and being independent of highly elastic steam, would not expose the materials to the destructive heat which was necessary for working Savery's engine. Supposing a perfect vacuum to be produced under the piston in the cylinder, an effective downward pressure would be obtained, amounting to fifteen times as many pounds as there are square inches in the section of the piston.* Thus, if the base of the piston were 100 square inches, a pressure equal to 1,500 pounds would be obtained.

In order to accomplish this, two things were necessary: 1. To make a speedy and effectual vacuum below the piston in the descent; and, 2. To contrive a counterpoise for the atmosphere in the ascent.

The condensation of steam immediately presented itself as the most effectual means of accomplishing the former; and the elastic force of the same steam previous to condensation an obvious method of affecting the latter. Nothing now remained to carry the design into execution, but the contrivance of means for the alternate introduction and condensation of the steam; and Newcomen and Cawley were accordingly granted a patent in 1707, in which Savery was

* As the calculation of the power of an engine depends on the number of square inches in the section of the piston, it may be useful to give a rule for computing the number of square inches in a circle. The following rule will always give the dimensions with sufficient accuracy: *Multiply the number of inches in the diameter by itself; divide the product by 14, and multiply the quotient thus obtained by 11, and the result will be the number of square inches in the circle.* Thus, if there be 12 inches in the diameter, this multiplied by itself gives 144, which divided by 14 gives $10\frac{4}{7}$, which multiplied by 11 gives 113, neglecting fractions. There are, therefore, 113 square inches in a circle whose diameter is 12 inches.

united, in consequence of the principle of condensation for which he had previously received a patent being necessary to the projected machine. We shall now describe the *atmospheric engine*, as first constructed by Newcomen:—

The boiler K (fig. 4) is placed over a furnace I, the flue of which winds round it, so as to communicate heat to every part of the bottom of it. In the top, which is hemispherical, two gauge-cocks G G' are placed, as in Savery's engine, and a *puppet valve* V, which opens upward, and is loaded at one pound per square inch; so that when the steam produced in the boiler exceeds the pressure of the atmosphere by more than one pound on the square inch, the valve V is lifted, and the steam escapes through it, and continues to escape until its pressure is sufficiently diminished, when the valve V again falls into its seat. This valve performs the office of the safety-valve in modern engines.

The great steam-tube is represented at S, which conducts steam from the boiler to the cylinder; and a feeding pipe T, furnished with a cock, which is opened and closed at pleasure, proceeds from a cistern L to the boiler. By this pipe the boiler may be replenished from the cistern, when the gauge-cock G' indicates that the level has fallen below it. The cistern L is supplied with hot water, by means which we shall presently explain.

To understand the mechanism necessary to work the piston, let us consider how the supply and condensation of steam must be regulated. When the piston has been forced to the bottom of the cylinder by the atmospheric pressure acting against a vacuum, in order to balance that pressure, and enable it to be drawn up by the weight of the pump-rod, it is necessary to introduce steam from the boiler. This is accomplished by opening the cock R in the steam-pipe S. The steam being thus introduced from the boiler, its pressure balances the action of the atmosphere upon the piston, which is immediately drawn to the top of the cylinder by the weight of the pump-rod D. It then becomes necessary to condense this steam, in order to produce a vacuum. To accomplish this, the further supply of steam must be cut off, which is done by closing the cock R. The supply of steam from the boiler being thus suspended, the application of cold water on the external surface of the cylinder becomes necessary to condense the steam within it. This was done by enclosing the cylinder within another, leaving a space between them.* Into this space cold water was allowed to flow from a cock M placed over it, supplied by a pipe from the cistern N. This cistern is supplied with water by a pump O, which is worked by the engine.

The cold water supplied from M, having filled the space between the two cylinders, abstracts the heat from the inner one; and condensing the steam, produces a vacuum, into which the piston is forced by the atmospheric pressure. Preparatory to the next descent, the water which thus fills the space between the cylinders, and which is warmed by the heat abstracted from the steam, must be discharged, in order to give room for a fresh supply of cold water from M. An aperture, furnished with a cock, is accordingly provided in the bottom of the cylinder, through which the water is discharged into the cistern L; and being warm, is adapted for the supply of the boiler through T, as already mentioned.

The cock R being now again opened, steam is admitted below the piston, which, as before, ascends, and the descent is again accomplished by closing the cock R, and opening the cock M, admitting cold water between the cylinders, and thereby condensing the steam below the piston.

The condensed steam, thus reduced to water, will collect in the bottom of the cylinder, and resist the descent of the piston. It is therefore, necessary to provide an exit for it, which is done by a valve opening *outward* into a tube

* The external cylinder is not represented in the diagram.

which leads to the feeding cistern L, into which the condensed steam is driven. That the piston should continue to be air-tight, it was necessary to keep a constant supply of water over it; this was done by a cock similar to M, which allowed water to flow from the pipe M on the piston.

Soon after the first construction of these engines, an accidental circumstance suggested to Newcomen a much better method of condensation than the application of cold water on the external surface of the cylinder. An engine was observed to work several strokes with unusual rapidity, and without the regular supply of the condensing water. Upon examining the piston, a hole was found in it, through which the water, which was poured on to keep it air-tight, flowed, and instantly condensed the steam under it.

On this suggestion Newcomen abandoned the external cylinder, and introduced a pipe H, furnished with a cock Q, into the bottom of the cylinder, so that, on turning the cock, the pressure of the water in the pipe H, from the level of the water in the cistern N, would force the water to rise as a jet into the cylinder, and would instantly condense the steam. This method of condensing by injection formed a very important improvement in the engine, and is still used.

Having taken a general view of the parts of the atmospheric engine, let us now consider more particularly its operation.

When the engine is not working, the weight of the pump-rod D (fig. 4) draws down the beam A, and draws the piston to the top of the cylinder, where it rests. Let us suppose all the cocks and valves closed, and the boiler filled to the proper depth. The fire being lighted beneath it, the water is boiled until the steam acquires sufficient force to lift the valve V. When this takes place, the engine may be started. For this purpose the regulating valve R is opened. The steam rushes in, and is first condensed by the cold cylinder. After a short time the cylinder acquires the temperature of the steam, which then ceases to be condensed, and mixes with the air which filled the cylinder. The steam and heated air, having a greater force than the atmospheric pressure, will open a valve placed at the end X of a small tube in the bottom of the cylinder, and which opens outward. From this (which is called the *blowing valve**) the steam and air rush in a constant stream, until all the air has been expelled, and the cylinder is filled with the pure vapor of water. This process is called *blowing* the engine preparatory to starting it.

When it is about to be started, the engine-man closes the regulator R, and thereby suspends the supply of steam from the boiler. At the same time he opens the *condensing valve* H;† and thereby throws up a jet of cold water into the cylinder. This immediately condenses the steam contained in the cylinder, and produces the vacuum. (The atmosphere cannot enter the *blowing valve*, because it opens *outward*, so that no air can enter to vitiate the vacuum.) The atmospheric pressure above the piston now takes effect, and forces it down in the cylinder. The descent being completed, the engine-man closes the condensing valve H, and opens the regulator R. By this means he stops the play of the jet within the cylinder, and admits the steam from the boiler. The first effect of the steam is to expel the condensing water and condensed steam which are collected in the bottom of the cylinder, through the tube Y, containing a valve which opens *outward* (called the *eduction valve*), which leads to the hot cistern L, into which this water is therefore discharged.

When the steam admitted through R ceases to be condensed, it balances the atmospheric pressure above the piston, and thus permits it to be drawn to

* Also called the *snifting valve*, from the peculiar noise made by the air and steam escaping from it.

† Also called the *injection valve*.

the top of the cylinder by the weight of the rod D. This ascent of the piston is also assisted by the circumstance of the steam being somewhat stronger than the atmosphere.

When the piston has reached the top, the regulating valve R is closed, and the condensing valve H opened, and another descent produced, as before, and so the process is continued.

The manipulation necessary in working this engine was, therefore, the alternate opening and closing of two valves; the regulating and condensing valves. When the piston reached the top of the cylinder, the former was to be closed, and the latter opened; and, on reaching the bottom, the former was to be opened, and the latter closed.

The duty of working the engine requiring no great amount of labor, or skill, was usually intrusted to boys, called, *cock boys*. It happened that one of the most important improvements which has ever been made in the working of steam-engines was due to the ingenuity of one of these boys. It is said that a lad, named *Humphrey Potter*, was employed to work the cocks of an atmospheric engine, and being tempted to escape from the monotonous drudgery to which his duty confined him, his ingenuity was sharpened so as to prompt him to devise some means by which he might indulge his disposition to play without exposing himself to the consequences of suspending the performance of the engine. On observing the alternate ascending and descending motion of the beam above him, and considering it in reference to the labor of his own hands, in alternately raising and lowering the levers which governed the cocks, he perceived a relation which served as a clue to a simple contrivance, by which the steam-engine, for the first time, became an automaton. When the beam arrived at the top of its play, it was necessary to open the steam-valve by raising a lever, and to close the injection valve by raising another. This he saw could be accomplished by attaching strings of proper length to these levers, and tying them to some part of the beam. These levers required to be moved in the opposite direction when the beam attained the lowest point of its play. This he saw could be accomplished by strings, either connected with the outer arm of the beam, or conducted over rods or pulleys. - In short, he contrived means of so connecting the levers which governed the two cocks by strings with the beam, that the beam opened and closed these cocks with the most perfect regularity and certainty as it moved upward and downward.

Besides rendering the machine independent of manual superintendence, this process conferred upon it much greater regularity of performance than any manual superintendence could insure.

This contrivance of Potter was very soon improved by the substitution of a bar, called a *plug-frame*, which was suspended from the arm of the beam, and which carried upon it pins, by which the arms of the levers governing the cocks were struck as the plug-frame ascended and descended, so as to be opened and closed at the proper times.

The engine thus improved required no other attendance except to feed the boiler occasionally by the cock T, and to attend the furnace.

However the merit of the discovery of the physical principles on which the mechanical application of steam depends may be awarded, it must be admitted that the engine contrived by Newcomen and his associates, considered as a practical machine, was immeasurably superior to that which preceded it; superior, indeed, to such a degree, that while the one was incapable of any permanently useful application, the other soon became a machine of extensive utility in the drainage of mines; and, even at the present time, the atmospheric engine is not unfrequently used in preference to the modern steam-engine, in districts where fuel is abundant and cheap; the expense of constructing and

maintaining it being considerably less than that of an improved steam-engine. The low pressure of the steam used in working it, rendered it perfectly safe. While Savery's engine, to work with effect, required that the steam confined in the vessels should have a bursting pressure amounting to about thirty pounds per square inch, the pressure of steam in the boiler and cylinder of the atmospheric engine required only a pressure about one pound per square inch. The high pressure also of the steam used in Savery's engine, was necessarily accompanied, as we shall presently explain, by a greatly increased temperature. The effect of this was, to weaken and gradually destroy the vessels, especially those which, like the steam-vessels V and V' (fig. 3), were alternately heated and cooled.

Besides these defects, the power of Savery's engines was also very restricted, both as to the quantity of water raised and as to the height to which it was elevated. On the other hand, the atmospheric engine was limited in its power only by the dimensions of its piston. Another considerable advantage which the atmospheric engine possessed over that of Savery, was the facility with which it was capable of driving machinery by means of the working-beam. The merit, however, of Newcomen's engine, regarded as an invention, and apart from merely practical considerations, must be ascribed principally to its mechanism and combinations. We find in it no new principle, and scarcely even a novel application of a principle. The agency of the atmospheric pressure acting against a vacuum, or partial vacuum, had been long known: the method of producing a vacuum by the condensation of steam had been suggested by Papin, and carried into practical effect by Savery. The mechanical power obtained from the direct pressure of the elastic force of steam, used in the atmospheric engine to balance the atmosphere during the ascent of the piston, was suggested by De Caus and Lord Worcester. The boiler, gauge-pipes, and the regulator, were all borrowed from the engine of Savery. The idea of using the atmospheric pressure against a vacuum or partial vacuum, to work a piston in a cylinder, had been suggested by Otto Guericke, an ingenious German philosopher, who invented the air-pump; and this, combined with the production of a vacuum by the condensation of steam, was subsequently suggested by Papin. The use of a working-beam could not have been unknown. Nevertheless, the judicious combination of these scattered principles must be acknowledged to deserve considerable credit. In fact, the mechanism contrived by Newcomen rendered a machine which was before altogether inefficient, highly efficient: and, as observed by Tredgold, such a result, considered in a practical sense, should be more highly valued than the fortuitous discovery of a physical principle.

THE STEAM-ENGINE.

(SECOND LECTURE.)

Mechanical Force of Steam.—Facts to be remembered.—Watt finds Condensation in the Cylinder incompatible with a due Economy of Fuel.—Conceives the notion of Condensing out of the Cylinder.—Discovers separate Condensation.—Invents the Air-Pump.—Substitutes Steam Pressure for Atmospheric Pressure.—Invents the Steam Case or Jacket.—His first Experiments to realize these Inventions.—His Experimental Apparatus.—His Models at Delft House.—Difficulties of bringing the improved Engines into Use.—Watt employed by Roebuck.—His Partnership.—His first Patent.—His Single-Acting Engine.—Discovery of the Expansive Action of Steam.—Its Mechanical Effects.—Its Variable Action.—Methods of Equalizing it.—Its extensive Application in the Cornish Engines.—Extension of the Steam-Engine to Manufactures.—Attempts of Papin, Savery, Hull, Champion, Stewart, and Washborough.—Watt's second Patent.—Sun and Planet Wheels.—Valves of Double-Acting Engine.

THE STEAM-ENGINE.

(SECOND LECTURE.)

HAVING explained in a former lecture the conditions under which, by supplying heat to water, it is converted into steam, and, by abstracting heat from steam, it may be reconverted into water, let us now consider the mechanical force which is developed in these phenomena.

Fig. 5.

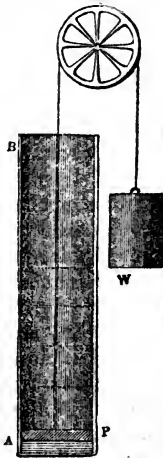

Let A B (fig. 5) be a tube, or cylinder, the base of which is equal to a square inch, and let a piston P move in it so as to be steam-tight. Let it be supposed, that under this piston there is, in the bottom of the cylinder, a cubic inch of water between the bottom of the piston and the bottom of the tube;

let the piston be counterbalanced by a weight W acting over a pulley, which will be just sufficient to counterpoise the weight of the piston, so as leave no force tending to keep the piston down, except the force of the atmosphere acting above it. Under the circumstances here supposed, the piston being in contact with the water, and all air being excluded, it will be pressed down by the weight of the atmosphere, which we will suppose to be fifteen pounds, the magnitude of the piston being a square inch.

Now let the flame of a lamp be applied at the bottom of the tube; the water under the piston having its temperature thereby gradually raised, and being submitted to no pressure save that of the atmosphere above the piston, it will begin to be converted into steam when it has attained the temperature of 212° . According as it is converted into steam, it will cause the piston to ascend in the tube until all the water has been evaporated. If the tube were constructed of sufficient length, the piston then would be found to have risen to the height of about seventeen hundred inches, or one hundred and forty-two feet; since, as has been already explained, water passing into steam under the ordinary pressure of the atmosphere undergoes an increase of bulk in the proportion of about seventeen hundred to one.

Now in this process, the air above the piston, which presses on it with a force equal to fifteen pounds, has been raised one hundred and forty-two feet. It appears, therefore, that, by the evaporation of a cubic inch of water under a pressure equal to fifteen pounds per square inch, a mechanical force of this amount is developed.

It is evident that fifteen pounds raised one hundred and forty-two feet successively, is equivalent to one hundred and forty-two times fifteen pounds raised one foot. Now, one hundred and forty-two times fifteen is two thousand one hundred and thirty, and therefore the force thus obtained is equal to two thousand one hundred and thirty pounds raised one foot high. This being within about 110 pounds of a ton, it may be stated, in round numbers, that, by the evaporation of a cubic inch of water under these circumstances, a force is obtained equal to that which would raise a ton weight a foot high.

The augmentation of volume which water undergoes in passing into steam under the pressure here supposed, may be easily retained in the memory, from the accidental circumstance that a cubic inch of water is converted into a cubic foot of steam, very nearly. A cubic foot contains one thousand seven hundred and twenty-eight cubic inches—which is little different from the proportion which steam bears to water, when raised under the atmospheric pressure.

It will, therefore, be an advantage to retain in memory the following general facts:—

1. *A cubic inch of water evaporated under the ordinary atmospheric pressure, is converted into a cubic foot of steam.*
2. *A cubic inch of water evaporated under the atmospheric pressure, gives a mechanical force equal to what would raise about a ton weight a foot high.*

Let us, again, suppose the piston P (fig. 5) to be restored to its original position, with the liquid water beneath it; and, in addition to the weight of the atmosphere which before pressed it down, let us suppose another weight of fifteen pounds laid upon it, so that the water below shall be pressed by double the weight of the atmosphere. If the lamp were now applied, and at the same time a thermometer were immersed in the water, it would be found that the water would not begin to be converted into steam until it attained the temperature of about 250° . The piston would then begin, as before, to ascend, and the water to be gradually converted into vapor. The water being completely evaporated, it would be found that the piston would be raised to a height little more than half its former height, or 72 feet. The mechanical effect,

therefore, thus obtained, will be equivalent to double the former weight raised half the former height.

In like manner, if the piston were loaded with thirty pounds in addition to the atmosphere, the whole pressure on the water being then three times the pressure first supposed, the piston would be raised to somewhat more than one third of its first height by the evaporation of the water. This would give a mechanical force equivalent to three times the original weight raised a little more than one third of the original height.

In general, as the pressure on the piston is increased, the height to which the piston would be raised by the evaporation of the water will be diminished in a proportion somewhat less than the proportion in which the pressure on the piston is increased. If the temperature at which the water is converted into steam under these different pressures were the same, then the height to which the piston would be raised by the evaporation of the water would be diminished in precisely the same proportion as the pressure on the piston is increased; and, in that case, the whole mechanical force developed by the evaporation of the water would remain exactly the same under whatever pressure the water might be boiled. We shall explain hereafter the extent to which the variation of temperature in the water and steam corresponding to the variation of pressure modifies this law; but, as the effect of the difference of temperatures is not considerable, it will be convenient to register in the memory the following important practical conclusion:—

A cubic inch of water converted into steam will supply a mechanical force very nearly equal to a ton weight raised a foot high; and this force will not be subject to considerable variation, whatever be the temperature or pressure at which the water may be evaporated.

At the period to which we have now brought the history of the invention of the steam-engine, WATT had directed his attention to the subject, and had obtained chiefly by his own experiments, a sufficient knowledge of the phenomena which have been just explained, to enable him to arrive at the conclusion that a very small proportion of the whole mechanical effect attending the evaporation was really rendered available by the atmospheric engine; and that, therefore, extensive and injurious sources of waste existed in its machinery.

He perceived that the principal source of this wasteful expenditure of power consisted in the quantity of steam which was condensed at each stroke of the piston, in heating the cylinder previous to the ascent of the piston. Yet, as it was evident that that ascent could not be accomplished in a cold cylinder, it was apparent that this waste of power must be inevitable, unless some expedient could be devised, by which a vacuum could be maintained in the cylinder, without cooling it. But, to produce such a vacuum, the steam must be condensed; and, to condense the steam, its temperature must be lowered to such a point that the vapor proceeding from it shall have no injurious pressure; yet, if condensed steam be contained in a cylinder at a high temperature, it will return to the temperature of the cylinder, recover its elasticity, and resist the descent of the piston.

Having reflected on these circumstances, it became apparent to Watt, that a vice was inherent in the structure of the atmospheric engine, which rendered a large waste of power inevitable; this vice arising from the fact, that the condensation of the steam was incompatible with the condition of maintaining the elevated temperature of the cylinder in which that condensation took place. It followed, therefore, either that the steam must be imperfectly condensed, or that the condensation could not take place in the cylinder. It was in 1765, that, pondering on these circumstances, the happy idea occurred to him, that the production of a vacuum could be equally effected, though the place where

the condensation of the steam took place were not the cylinder itself. He saw, that if a vessel in which a vacuum was produced were put into communication with another containing an elastic fluid, the elastic fluid would rush into the vacuum, and diffuse itself through the two vessels; but if, on rushing into such vacuum, this elastic fluid, being vapor, were there condensed, or restored to the liquid form, that then the space within the two vessels would be equally rendered a vacuum; that, under such circumstances, one of the vessels might be maintained at any temperature, however high, while the other might be kept at any temperature, however low. This felicitous conception formed the first step in that splendid career of invention and discovery which has conferred immortality on the name of Watt. He used to say, that the moment the idea of separate condensation occurred to him—that is, of condensing, in one vessel kept cold, the steam coming from another vessel kept hot—all the details of his improved engine rushed into his mind in such rapid succession, that, in the course of a day, his invention was so complete that he proceeded to submit it to experiment.

To explain the first conception of this memorable invention; let a tube or pipe, S (fig. 6), be imagined to proceed from the bottom of the cylinder A B

Fig. 6.

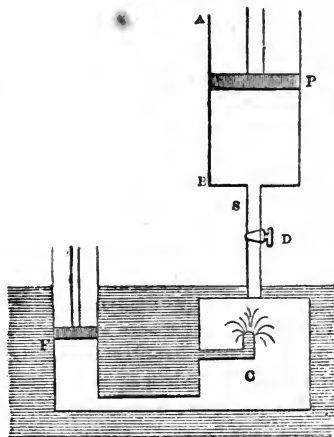

to a vessel, C, having a stop-cock, D, by which the communication between the cylinder and the vessel C may be opened or closed at pleasure. If we suppose the piston P at the top of the cylinder, and the space below it filled with steam, the cylinder and steam being at the usual temperature, while the vessel C is a vacuum, and maintained at a low temperature. Then, on opening the cock D, the steam will rush from the cylinder A B through the tube S, and, passing into the cold vessel C, will be condensed by contact with its cold sides. This process of condensation will be rendered instantaneous if a jet of cold water is allowed to play in the vessel C. When the steam thus rushing into C, has been destroyed, and the space in the cylinder A B becomes a vacuum, then the pressure of the atmosphere being unobstructed, the piston will descend with the force due to the excess of the pressure of the atmosphere above the friction. When it has descended, suppose the stop-cock D closed, and steam admitted from the boiler through a proper cock or valve below the piston, the cylinder and piston being still at the same temperature as before. The steam on entering the cylinder, not being exposed to contact with any

surface below its own temperature, will not be condensed, and therefore will immediately cause the piston to rise, and the piston will have attained the top of the cylinder when as much steam shall have been supplied by the boiler as will fill the cylinder. When this has taken place, suppose the communication with the boiler cut off, and the cock D once more opened; the steam will again rush through the pipe S into the vessel C, where encountering the cold surface and the jet of cold water, it will be condensed, and the vacuum, as before, will be produced in the cylinder A B; that cylinder still maintaining its temperature, the piston will again descend, and so the process may be continued.

Having carried the invention to this point, Watt saw that the vessel C would gradually become heated by the steam which would be continually condensed in it. To prevent this, as well as to supply a constant jet of cold water, he proposed to keep the vessel C submerged in a cistern of cold water, from which a pipe should conduct a jet to play within the vessel, so as to condense the steam as it would pass from the cylinder.

But here a difficulty presented itself, against which it was necessary to provide. The cold water admitted through the jet to condense the steam, mixed with the condensed steam itself, would gradually collect in the vessel C, and at length choke it. To prevent this, Watt proposed to put the vessel C in communication with a pump F, which might be wrought by the engine itself, and by which the water, which would collect in the bottom of the vessel C, would be constantly drawn off. This pump would be evidently rendered the more necessary, since more or less atmospheric air, always combined with water in its common state, would enter the vessel C by the condensing jet. This air would be disengaged in the vessel C by the heat of the steam condensed therein; and it would rise through the tube S, and vitiate the vacuum in the cylinder; an effect which would be rendered the more injurious, inasmuch as, unlike steam, this elastic fluid would be incapable of being condensed by cold. The pump F, therefore, by which Watt proposed to draw off the water from the vessel C, might also be made to draw off the air, or the principal part of it.

The vessel C was subsequently called a *condenser*; and, from the circumstances just adverted to, the pump F has been called the *air-pump*.

These—namely, the cylinder, the condenser, and the air-pump—were the three principal parts in the invention, as it first presented itself to the mind of Watt—and even before it was reduced to a model, or submitted to experiment. But, in addition to these, other two improvements offered themselves in the very first stage of its progress.

In the atmospheric engine, the piston was maintained steam-tight in the cylinder by supplying a stream of cold water above it, by which the small interstices between the piston and cylinder would be stopped. It is evident that the effect of this water as the piston descended would be to cool the cylinder, besides which any portion of it which might pass between the piston and cylinder and which would pass below the piston, would boil the moment it would fall into the cylinder, which itself would be maintained at the boiling temperature. This water, therefore, would produce steam, the pressure of which would resist the descent of the piston.

Watt perceived, that even though this inconvenience were removed by the use of oil or tallow upon the piston, still, that as the piston would descend in the cylinder, the cold atmosphere would follow it; and would, to a certain extent, lower the temperature of the cylinder. On the next ascent of the piston, this temperature would have to be again raised to 212° by the steam coming from the boiler, and would entail upon the machine a proportionate waste of power.

If the atmosphere of the engine-house could be kept heated to the temperature of boiling water, this inconvenience would be removed. The piston would then be pressed down by air as hot as the steam to be subsequently introduced into it. On further consideration, however, it occurred to Watt that it would be still more advantageous if the cylinder itself could be worked in an atmosphere of steam, having only the same pressure as the atmosphere. Such steam would press the piston down as effectually as the air would; and it would have the further advantage over air, that if any portion of it leaked through between the piston and cylinder, it would be condensed, which could not be the case with atmospheric air. He therefore determined on surrounding the cylinder by an external casing, the space between which and the cylinder he proposed to be filled with steam supplied from the boiler. The cylinder would thus be enclosed in an atmosphere of its own, independent of the external air, and the vessel so enclosing it would only require to be a little larger than the cylinder, and to have a close cover at the top, the centre of which might be perforated with a hole to admit the rod of the piston to pass through, the rod being made smooth, and so fitted to the perforation that no steam should escape between them. This method would be attended also with the advantage of keeping the cylinder and piston always heated, not only inside but outside; and Watt saw that it would be further advantageous to employ the pressure of steam to drive the piston in its descent instead of the atmosphere, as its intensity or force would be much more manageable; for, by increasing or diminishing the heat of the steam in which the cylinder was enclosed, its pressure might be regulated at pleasure, and might be made to urge the piston with any force that might be required. The power of the engine would therefore be completely under control, and independent of all variations in the pressure of the atmosphere.

This was a step which totally changed the character of the machine, and which rendered it a STEAM-ENGINE instead of an ATMOSPHERIC ENGINE. Not only was the vacuum below the piston now produced by the property of steam, in virtue of which it is reconverted into water by cold; but the pressure which urged the piston into this vacuum was due to the elasticity of steam.

The external cylinder, within which the working cylinder was enclosed, was called THE JACKET, and is still very generally used.

The first experiment in which Watt attempted to realize, on a small scale, his conceptions, was made in the following manner. The cylinder of the engine was represented by a brass syringe, A B (fig. 7), an inch and a third in diameter, and ten inches in length, to which a top and a bottom of tin plate was fitted. Steam was conveyed by a pipe, S, from a small boiler into the lower end of this syringe, a communication being made with the upper end of the syringe by a branch pipe, D. For the greater convenience of the experiment, it was found desirable to invert the position of the cylinder, so that the steam should press the piston P upward instead of downward. The piston-rod R therefore was presented downward. An eduction pipe, E, was also inserted in the top of the cylinder, which was carried to the condenser. The piston-rod was made hollow, or rather a hole was drilled longitudinally through it, and a valve was fitted at its lower end, to carry off the water produced by the steam, which would be condensed in the cylinder in the commencement of the process. The condenser used in this experiment operated without injection, the steam being condensed by the contact of cold surfaces. It consisted of two thin pipes, F G, of tin, ten or twelve inches in length, and the sixth of an inch in diameter, standing beside each other perpendicularly, and communicating at the top with the eduction pipe, which was provided with a valve opening upward. At the bottom these two pipes communicated with another tube, I, of about an inch in diameter, by a horizontal pipe, having in it a valve, M, open-

where it was reduced to water, so that a vacuum was left in the upper part of the cylinder. The steam from the boiler passing below the piston, pressed it upward with such force, that it lifted a weight of eighteen pounds hung from the end of the piston-rod. When the piston reached the top of the cylinder, the cocks L and N were closed, and the cock C opened. All communication between the cylinder and the boiler, as well as between the cylinder and the condenser, were now cut off, and the steam in the cylinder circulated freely above and below the piston, by means of the open tube D. The piston, being subject to equal forces upward and downward, would therefore descend by its own weight, and would reach the bottom of the cylinder. The air-pump piston meanwhile being drawn up, the air and the condensed steam in the tubes F and G were drawn into the air-pump I, through the open horizontal tube at the bottom. Its return was stopped by the valve M. By another stroke of the air-pump, this water and air were drawn out through valves in the piston, which opened upward. The cock C was now closed, and the cocks L and N opened, preparatory to another stroke of the piston. The steam in the upper part of the cylinder rushed, as before, into the tubes F and G, and was condensed by their cold surfaces, while steam from the boiler coming through the pipe S, pressed the piston upward. The piston again ascended with the same force as before, and in the same manner the process was continually repeated.

The quantity of steam expended in this experimental model in the production of a given number of strokes of the piston was inferred from the quantity of water evaporated in the boiler; and on comparing this with the magnitude of the cylinder and the weight raised by the pressure of the steam, the contrivance was proved to affect the economy of steam, as far as the imperfect conditions of such a model could have permitted. A larger model was next constructed, having an outer cylinder, or steam case, surrounding the working cylinder, and the experiments made with it fully realized Watt's expectations, and left no doubt of the great advantages which would attend his invention. The weights raised by the piston proved that the vacuum in the cylinder produced by the condensation was almost perfect; and he found that when he used water in the boiler which by long boiling had been well cleared of air, the weight raised was not much less than the whole amount of the pressure of the steam upon the piston. In this large model, the cylinder was placed in the usual position, with a working lever and other apparatus similar to that employed in the atmospheric engine.

It was in the beginning of the year 1765, Watt being then in the twenty-ninth year of his age, that he arrived at these great discoveries. The experimental models just described, by which his invention was first reduced to a rude practical test, were fitted up at a place called Delft house, in Glasgow. It will doubtless at the first view, be a matter of surprise that improvements of such obvious importance in the economy of steam power, and capable of being verified by tests so simple, were not immediately adopted wherever atmospheric engines were used. At the time, however, referred to, Watt was an obscure artisan, in a provincial town, not then arrived at the celebrity to which it has since attained, and the facilities by which inventions and improvements became public were much less than they have since become. It should also be considered that all great and sudden advances in the useful arts are necessarily opposed by the existing interests with which their effects are in conflict. From these causes of opposition, accompanied with the usual influence of prejudice and envy, Watt was not exempt, and was not therefore likely suddenly to revolutionize the arts and manufactures of the country by displacing the moving powers employed in them, and substituting an engine, the efficacy

and power of which depended mainly on physical principles, then altogether new and but imperfectly understood.

Not having the command of capital, and finding it impracticable to inspire those who had, with the same confidence in the advantages of his invention which he himself felt, he was unable to take any step toward the construction of engines on a large scale. Soon after this, he gave up his shop in Glasgow, and devoted himself to the business of a civil engineer. In this capacity he was engaged to make a survey of the river Clyde, and furnished an elaborate and valuable report upon its projected improvements. He was also engaged in making a plan of the canal, by which the produce of the Monkland Colliery was intended to be carried to Glasgow, and in superintending the execution of that work. Besides these, several other engineering enterprises occupied his attention, among which may be mentioned, the navigable canal across the isthmus of Crinan, afterward completed by Rennie; improvements proposed in the ports of Ayr, Glasgow, and Greenock; the construction of the bridges at Hamilton, and at Rutherglen; and the survey of the country through which the celebrated Caledonian canal was intended to be carried.

"If, forgetful of my duties as the organ of this academy," says M. Arago (whose eloquent observations on the delays of this great invention, addressed to the assembled members of the National Institute of France, we cannot forbear to quote), "I could think of making you smile, rather than expressing useful truths, I would find here matter for a ludicrous contrast. I would call to your recollection the authors, who at our weekly sittings demand with all their might and main (*à cor et à cris*) an opportunity to communicate some little remark—some small reflection—some trifling note, conceived and written the night before; I would represent them to you cursing their fate, when according to your rules, the reading of their communication is postponed to the next meeting, although during this cruel week, they are assured that their important communication is deposited in our archives in a sealed packet. On the other hand, I would point out to you the creator of a machine, destined to form an epoch in the annals of the world, undergoing patiently and without murmur, the stupid contempt of capitalists—conscious of his exalted genius, yet stooping for eight years to the common labor of laying down plans, taking levels, and all the tedious calculations connected with the routine of common engineering. While in this conduct you cannot fail to recognise the serenity, the moderation, and the true modesty of his character, yet such indifference, however nobly may have been its causes, has something in it not altogether blameless. It is not without reason that society visits with severe reprobation those who withdraw gold from circulation and hoard it in their coffers. Is he less culpable who deprives his country, his fellow-citizens, his age, of treasures a thousand times more precious than the produce of the mine; who keeps to himself his immortal inventions, sources of the most noble and purest enjoyment of the mind, who abstains from conferring upon labor those powers, by which would be multiplied in an infinite proportion the products of industry, and by which, with advantage to civilization and human nature, he would smooth away the inequalities of the conditions of man."*

Although Watt was thus attracted by pursuits foreign to his recent investigations respecting the improvement of steam power, he never lost sight of that object. It was not until the year 1768, three years after his great discoveries, that any step was taken to enable him to carry them into effect on a large scale. At that time his friends brought him into communication with Dr. Roebuck, the proprietor of the Carron Iron Works, who rented extensive coal works at Kinneal from the duchess of Hamilton. Watt was first employed by Roebuck as

* Eloge, p. 308.

a civil engineer; but when he made known to him the improvements he had projected in the steam-engine, Roebuck proposed to take out a patent for an engine on the principle of the model which had been fitted up at Delft house, and to join Watt in a partnership, for the construction of such engines. Sensible of the advantages to be derived from the influence of Roebuck, and from his command of capital, Watt agreed to cede to him two thirds of the advantages to be derived from the invention. A patent was accordingly taken out on the fifth of January, 1769, nearly four years after the invention had been completed; and an experimental engine on a large scale was constructed by him, and fitted up at Kinneal house. In the first trial this machine more than fulfilled Watt's anticipations. Its success was complete. In the practical details of its construction, however, some difficulties were still encountered, the greatest of which consisted in packing the piston, so as to be steam-tight. The principle of the new engine did not admit of water being kept upon the piston, to prevent leakage, as in the old engines; he was therefore obliged to have his cylinders much more accurately bored, and more truly cylindrical, and to try a great variety of soft substances for packing the piston, which would make it steam-tight without great friction, and maintain it so in a situation perfectly dry, and at the temperature of boiling water.

While Watt was endeavoring to overcome these and other difficulties, in the construction of the machine, his partner, Dr. Roebuck, became embarrassed, by the failure of his undertaking in the Borrowstouness coal and salt works; and he was unable to supply the means of prosecuting with the necessary vigor the projected manufacture of the new engines.

The important results of Watt's labors having happily at this time become more publicly known, Mr. Matthew Boulton, whose establishment at Soho, near Birmingham, was at that time the most complete manufactory for metal-work in England, and conducted with unexampled enterprise and spirit, proposed to purchase Dr. Roebuck's interest in the patent. This arrangement was effected in the year 1773, and in the following year Mr. Watt removed to Soho, where a portion of the establishment was allotted to him, for the erection of a foundry, and other works necessary to realize his inventions on a grand scale.

The patent which had been granted in 1769 was limited to a period of fourteen years, and would consequently expire about the year 1783. From the small progress which had hitherto been made in the construction of engines upon the new principle, and from the many difficulties still to be encountered, and the large expenditure of capital which must obviously be incurred before any return could be obtained, it was apparent that, unless an extension of the patent-right could be obtained, Boulton and Watt could never expect any advantage adequate to the risk of their great enterprise. In the year 1774 an application was accordingly made to parliament for an extension of the patent, which was supported by the testimony of Dr. Roebuck, and Mr. Boulton, and others, as to the merits and probable utility of the invention. An act was accordingly passed, in 1775, extending the term of the patent until the year 1800.

Thus protected and supported, Watt now directed the whole vigor of his mind to perfect the practical details of his invention; and the result was the construction, on a large scale, of the engine which has since been called his **SINGLE ACTING STEAM-ENGINE**.

It is necessary to recollect that, notwithstanding the extensive and various application of steam power in the arts and manufactures at the time to which our narrative has now reached, the steam-engine had never been employed for any other purpose, save that of raising water by working pumps. The motion, therefore, which was required was merely an upward force, such as was ne-

cessary to elevate the piston of a pump, loaded with the column of water which it raised. The following, then, is a description of the improved engine of Watt, by which such work was proposed to be performed :—

Fig. 8.

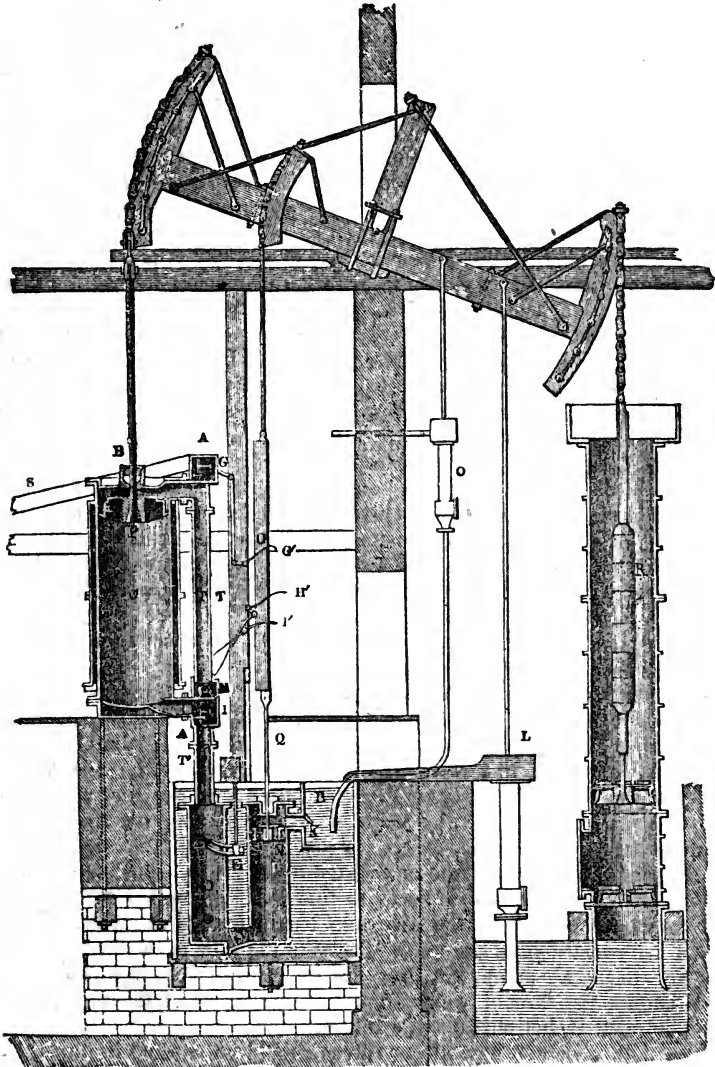

In the cylinder represented at C (fig. 8), the piston P moves steam-tight. It is closed at the top, and the piston-rod, being accurately turned, runs in a steam-tight collar B, furnished with a stuffing-box, and is constantly lubricated with melted tallow. A funnel is screwed into the top of the cylinder, through which, by opening a stop-cock, melted tallow is permitted from time to time to fall upon the piston within the cylinder, so as to lubricate it, and keep it steam-tight. Two boxes, A A, called the upper and lower steam-boxes, contain

valves by which steam from the boiler may be admitted and withdrawn. These steam-boxes are connected by a tube of communication T, and they communicate with the cylinder at the top and bottom by short tubes represented in the figure. The upper steam-box A contains one valve, by which a communication with the boiler may be opened or closed at pleasure. The lower valve-box contains two valves. The lower valve I communicates with the tube T', leading to the condenser D, which being opened or closed, a communication is made or cut off at pleasure, between the cylinder C and the condenser D. A second valve, or upper valve H, which is represented closed in the figure, may be opened so as to make a free communication between the cylinder C and the tube T, and by that means between the cylinder C, below the piston, and the space above the piston. The condenser D is submerged in a cistern of cold water. At the side there enters it a tube, E, governed by a cock, which, being opened or closed to any required extent, a jet of cold water may be allowed to play in the condenser, and may be regulated or stopped at pleasure. This jet, when playing, throws the water upward in the condenser toward the mouth of the tube T', as water issues from the nose of a watering-pot. The tube S proceeds from the boiler, and terminates in the steam-box A, so that the steam supplied from the boiler constantly fills that box. The valve G is governed by levers, whose pivots are attached to the framing of the engine, and is opened or closed at pleasure, by raising or lowering the lever G'. The valve G, when open, will therefore allow steam to pass from the boiler through the short tube to the top of the piston, and this steam will also fill the tube T. If the lower valve H be closed, its circulation beyond that point will be stopped; but if the valve H be open, the valve I being closed, then the steam will circulate equally in the cylinder, above and below the piston. If the valve I be open, then steam will rush through the tube T' into the condenser; but this escape of the steam will be stopped, if the valve I be closed. The valve H is worked by the lever H', and the valve I by the lever I'.

The valve G is called the upper steam-valve, H the lower steam-valve, I the exhausting valve, and E the condensing valve.

From the bottom of the condenser D proceeds a tube leading to the air-pump, which is also submerged in the cistern of cold water. In this tube is a valve M, which opens outward from the condenser toward the air-pump. In the piston of the air-pump N, is a valve which opens upward. The piston-rod Q of the air-pump is attached to a beam of wood called a plug-frame, which is connected with the working-beam by a flexible chain playing on the small arch-head immediately over the air-pump. From the top of the air-pump barrel above the piston proceeds a pipe or passage leading to a small cistern B called the hot-well. The pipe which leads to this well is supplied with a valve, K, which opens outward from the air-pump barrel toward the well. From the nature of its construction, the valve M admits the flow of water from the condenser toward the air-pump, but prevents its return; and, in like manner, the valve K admits the flow of water from the upper part of the air-pump barrel into the hot-well B, but obstructs its return.

Let us now consider how these valves should be worked in order to move the piston upward and downward with the necessary force. It is, in the first place, necessary that all the air which fills the cylinder, the tubes, and the condenser, shall be expelled. To accomplish this, it is only necessary to open at once the three valves, G, H, and I. The steam then rushing from the boiler through the steam-pipe S, and the open valve G will pass into the cylinder above the piston, will fill the tube T, pass through the lower steam-valve H, will fill the cylinder C below the piston, and will pass through the open valve I into the condenser. If the valve E be closed so that no jet shall play in the

condenser, the steam rushing into it will be partially condensed by the cold surfaces to which it will be exposed; but if the boiler supply it through the pipe S in sufficient abundance, it will rush with violence through the cylinder and all the passages, and its pressure in the condenser D, combined with that of the heated air with which it is mixed, will open the valve M, and it will rush through, mixed with the air, into the air-pump barrel N. It will press the valves in the air-pump piston upward, and, opening them, will rush through, and will collect in the air-pump barrel above the piston. It will then, by its pressure, open the valve K, and will escape into the cistern B.

Throughout this process, the steam which mixed with the air fills the cylinder, condenser, and air-pumps, will be only partially condensed in the last two, and it will escape, mixed with the air, through the valve K; and this process will continue until all the atmospheric air which at first filled the cylinder, tubes, condenser, and air-pump barrel, shall be expelled through the valve K, and these various spaces shall be filled with pure steam. When that has happened, let us suppose all the valves closed. In closing the valve I, the flow of steam to the condenser will be stopped, and the steam contained in it will speedily be condensed by the cold surface of the condenser, so that a vacuum will be produced in the condenser, the condensed steam falling in the form of water to the bottom. In like manner, and for like reasons, a vacuum will be produced in the air-pump. The valve M, and the valves in the air-pump piston, will be closed by their own weight.

By this process, which is called *blowing through*, the atmospheric air, and other permanent gases, which filled the cylinder, tubes, condenser, and air-pump, are expelled, and these spaces will be a vacuum. The engine is then prepared to be started, which is effected in the following manner: The upper steam-valve G is opened, and steam allowed to flow from the boiler through the passage leading to the top of the cylinder. This steam cannot pass to the bottom of the cylinder, since the lower steam-valve H is closed. The space in the cylinder below the piston being therefore a vacuum, and the steam pressing above it, the piston will be pressed downward with a corresponding force. When it has arrived at the bottom of the cylinder, the steam-valve G must be closed, and at the same time the valve H opened. The valve I leading to the condenser being also closed, the steam which fills the cylinder above the piston is now admitted to circulate through the open valve H below the piston, so that the piston is pressed equally upward and downward by steam, and there is no force to resist its movement, save its friction with the cylinder. The weight of the pump-rods on the opposite end of the beam being more than equivalent to overcome this, the piston is drawn to the top of the cylinder, and pushes before it the steam which is drawn through the tube T, and the open valve H, and passes into the cylinder C below the piston.

When the piston has thus arrived once more at the top of the cylinder, let the valve H be closed, and at the same time the valves G and I opened, and the condensing-cock E also opened, so as to admit the jet to play in the condenser. The steam which fills the cylinder C below the piston, will now rush through the open valve I into the condenser which has been hitherto a vacuum, and there encountering the jet, will be instantly converted into water, and a mixture of condensed steam and injected water will collect in the bottom of the condenser. At the same time, the steam proceeding from the boiler by the steam-pipe S to the upper steam-box A, will pass through the open steam-valve G to the top of the piston, but cannot pass below it because of the lower steam-valve H being closed. The piston, thus acted upon above by the pressure of the steam, and the space in the cylinder below it being a vacuum, its downward motion is resisted by no force but the friction, and it is therefore

driven to the bottom of the cylinder. During its descent, the valves G, I, and E, remain open. At the moment it arrives at the bottom of the cylinder, all these three valves are closed, and the valve H opened. The steam which fills the cylinder above the piston is now permitted to circulate below it, by the open valve H and the piston being consequently pressed equally upward and downward, will be drawn upward as before by the preponderance of the pump-rods at the opposite end of the beam. The weight of these rods must also be sufficiently great to draw the air-pump piston N upward. As this piston rises in the air-pump, it leaves a vacuum below it, into which the water and air collected in the condenser will be drawn through the valve M, which opens outward. When the air-pump piston has arrived at the top of the barrel, which it will do at the same time that the steam-piston arrives at the top of the cylinder, the water and the chief part of the air or other fluids which may have been in the condenser, will be drawn into the barrel of the air-pump, and the valve M being closed by its own weight, assisted by the pressure of these fluids, they cannot return into the condenser. At the moment the steam-piston arrives at the top of the cylinder, the valve H is closed, and the three valves G, I, and E, are opened. The effect of this change is the same as was already described in the former case, and the piston will in the same manner and from the same causes be driven downward. The air-pump piston will at the same time descend by the force of its own weight, aided by the weight of the plug-frame attached to its rod. As it descends, the air below it will be gradually compressed above the surface of the water in the bottom of the barrel, until its pressure becomes sufficiently great to open the valves in the air-pump piston. When this happens, the valves in the air-pump piston, as represented on a large scale in fig. 9, will be opened, and the air will pass through them

Fig. 9.

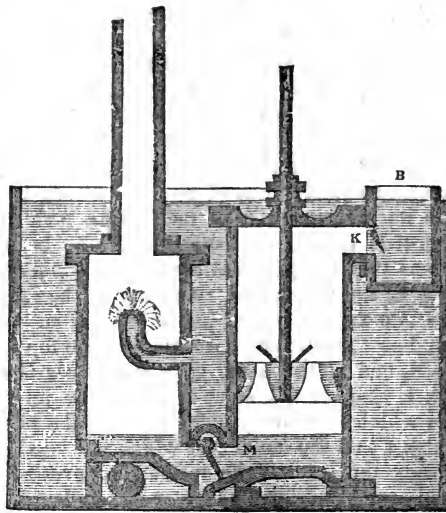

above the piston. When the piston comes in contact with the water in the bottom of the barrel, this water will likewise pass through the open valves. When the piston has arrived at the bottom of the air-pump barrel, the valves in it will be closed by the pressure of the fluids above them. The next ascent of the steam piston will draw up the air-pump piston, and with it the fluids in

the pump barrel above it. As the air-pump piston approaches the top of its barrel, the air and water above it will be drawn through the valve K into the hot cistern B. The air will escape in bubbles through the water in that cistern, and the warm water will be deposited in it.

The magnitude of the opening in the condensing valve E, must be regulated by the quantity of steam admitted to the cylinder. As much water ought to be supplied through the injection valve as will be sufficient to condense the steam contained in the cylinder, and also to reduce the temperature of the water itself, when mixed with the steam, to a sufficiently low degree to prevent it from producing vapor of a pressure which would injuriously affect the working of the piston. It has been shown, that five and a half cubic inches of ice-cold water mixed with one cubic inch of water in the state of steam would produce six and a half cubic inches of water at the boiling temperature. If then the cylinder contained one cubic inch of water in the state of steam, and only five and a half cubic inches of water were admitted through the condensing jet, supposing this water, when admitted, to be at the temperature of 32° , then the consequence would be that six and a half cubic inches of water at the boiling temperature would be produced in the condenser. Steam would immediately arise from this, and at the same time the temperature of the remaining water would be lowered by the amount of the latent heat taken up by the steam so produced. This vapor would rise through the open exhausting valve I, would fill the cylinder below the piston, and would impair the efficiency of the steam above pressing it down. The result of the inquiries of Watt respecting the pressure of steam at different temperatures, showed, that to give efficiency to the steam acting upon the piston it would always be necessary to reduce the temperature of the water in the condenser to 100° .

Let us then see what quantity of water at the common temperature would be necessary to produce these effects.

If the latent heat of steam be taken at $1,000^{\circ}$, a cubic inch of water in the state of steam may be considered for the purposes of this computation, as equivalent to one cubic inch of water at $1,212^{\circ}$. Now the question is, how many cubic inches of water at 60° must be mixed with this, in order that the mixture may have the temperature of 100° ? This will be easily computed. As the cubic inch of water at $1,212^{\circ}$ is to be reduced to 100° , it must be deprived of $1,112^{\circ}$ of its temperature. On the other hand, as many inches of water at 60° as are to be added, must be raised in the same mixture to the temperature of 100° , and therefore each of these must receive 40° of temperature. The number of cubic inches of water necessary to be added will therefore be determined by finding how often 40° are contained in $1,112^{\circ}$. If $1,112$ be divided by 40 , the quotient will be 27.8 . Hence it appears, that to reduce the water in the condenser to the temperature of 100° , supposing the temperature of the water injected to be 60° , it will be necessary to supply by the injection cock very nearly twenty-eight times as much water as passes through the cylinder in the state of steam; and therefore if it be supposed that all the water evaporated in the boiler passes through the cylinder, it follows that about twenty-eight times as much water must be thrown into the condenser as is evaporated in the boiler.

From these circumstances it will be evident that the cold cistern in which the condenser and air-pump are submerged, must be supplied with a considerable quantity of water. Independently of the quantity drawn from it by the injection valve, as just explained, the water in the cistern itself must be kept down to a temperature of about 60° . The interior of the condenser and air-pump being maintained by the steam condensed in them at a temperature not less than 100° ; the outer surfaces of these vessels consequently impart heat

to the water in the cold cistern, and have therefore a tendency to raise the temperature of that water. To prevent this, a pump called the *cold pump*, represented at L in fig. 8, is provided. By this pump water is raised from any convenient reservoir, and driven through proper tubes into the cold cistern. This cold pump is wrought by the engine, the rod being attached to the beam. Water being, bulk for bulk, heavier the lower its temperature, it follows that the water supplied by the cold pump to the cistern will have a tendency to sink to the bottom, pressing upward the warmer water contained in it. A waste-pipe is provided, by which this water is drained off, and the cistern therefore maintained at the necessary temperature.

From what has been stated, it is also evident that the hot well B, into which the warm water is thrown by the air-pump, will receive considerably more water than is necessary to feed the boiler. A waste-pipe, to carry off this, is also provided; and the quantity necessary to feed the boiler is pumped up by a small pump, O, the rod of which is attached to the beam, as represented in fig. 8, and which is worked by the engine. The water raised by this pump is conducted to a reservoir from which the boiler is fed, by means which will be hereafter explained.

We shall now explain the manner in which the machine is made to open and close the valves at the proper times. By referring to the explanation already given, it will be perceived that at the moment the piston reaches the top of the cylinder, the upper steam-valve G must be open, to admit the steam to press it down; while the exhausting valve I must be opened, to allow the steam to pass to the condenser; and the condensing valve E must be opened, to let in the water necessary for the condensation of the steam; and at the same time the lower steam-valve H must be closed, to prevent the passage of the steam which has been admitted through G. The valves G, I, and E, must be kept open, and the valve H kept closed, until the piston arrives at the bottom of the cylinder, when it will be necessary to close all the three valves, G, I, and E, and to open the valve H, and the same effects must be produced each time the piston arrives at the top and bottom of the cylinder. All this is accomplished by a system of levers, which are exhibited in fig. 8. The pivots on which these levers play are represented on the framing of the engine, and the arms of the levers G', H', and I', communicating with the corresponding valves G, H, and I, are represented opposite a bar attached to the rod of the air-pump, called the *plug-frame*. This bar carries certain pegs and detents, which act upon the arms of the several levers in such a manner that, on the arrival of the beam at the extremities of its play upward and downward, the levers are so struck that the valves are opened and closed at the proper times. It is needless to explain all the details of this arrangement. Let it be sufficient, as an example of all, to explain the method of working the upper steam-valve G. When the piston reaches the top of the cylinder, a pin strikes the arm of the lever G', and throws it upward: this, by means of the system of levers, pulls the arm of the valve G downward, by which the upper steam-valve is raised out of its seat, and a passage is opened from the steam-pipe to the cylinder. The valve is maintained in this state until the piston reaches the bottom of the cylinder, when the arm G' is pressed downward, by which the arm G is pressed upward, and the valve restored to its seat. By similar methods the levers governing the other three valves, H, I, and E, are worked.

The valves used in these engines were of the kind called *spindle-valves*. They consisted of a flat circular plate of bell metal, A D, fig. 10, with a round spindle passing perpendicularly through its centre, and projecting above and below it. This valve, having a conical form, was fitted very exactly, by grinding into a corresponding circular conical seat, A B-C D, fig. 11, which

Fig. 10.



forms the passage which it is the office of the valve to open and close. When the valve falls into its seat, it fits the aperture like a plug, so as entirely to stop it. The spindle plays in sockets or holes, one above and the other below the aperture which the valve stops; these holes keep the valve in its proper position, so as to cause it to drop exactly into its place.

Fig. 11.

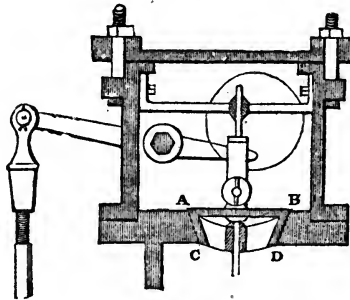

In the experimental engine made by Mr. Watt at Kinneal, he used cocks, and sometimes sliding covers, like the regulator described in the old engines; but these he found very soon to become leaky. He was, therefore, obliged to change them for the spindle-valves just described, which, being truly ground, and accurately fitted in the first instance, were not so liable to go out of order. These valves are also called *puppet-clacks*, or *button-valves*.

In the earlier engines constructed by Watt, the condensation was produced by the contact of cold surfaces, without injection. The reason of rejecting the method of condensing by injection was, doubtless, to avoid the injurious effects of the air, which would always enter the condenser, in combination with the water of condensation, and vitiate the vacuum. It was soon found, however, that a condenser acting by cold surfaces without injection, being necessarily composed of narrow pipes or passages, was liable to incrustation from bad water, by which the conducting power of the material of the condenser was diminished; so that, while its outer surface was kept cold by the water of the cold cistern, the inner surface might, nevertheless, be so warm that a very imperfect condensation would be produced.

At the time that Watt, in conjunction with Dr. Roebuck, obtained the patent for his improved engine, the idea occurred to him, that the steam which had impelled the piston in its descent rushed from the cylinder with a mechanical force much more than sufficient to overcome any resistance which it had to encounter in its passage to the condenser; and that such force might be fendered available as a moving power, in addition to that already obtained from the steam during the stroke of the piston. This motion involved the whole

principle of the expansive action of steam, which subsequently proved to be of such importance in the performance of steam-engines. Watt was, however, so much engrossed at that time, and subsequently, by the difficulties he had to encounter in the construction of his engines, that he did not attempt to bring this principle into operation. It was not until after he had organized that part of the establishment at Soho which was appropriated to the manufacture of steam-engines, that he proceeded to apply the expansive principle. Since the date of the patent which he took out for this (1782) was subsequent to the application of the same principle by another engineer, named Hornblower, it is right to state that the claim of Mr. Watt to this important step in the improvement of the steam-engine, is established by a letter addressed by him to Dr. Small, of Birmingham, dated Glasgow, May, 1769 :—

“ I mentioned to you a method of still doubling the effect of the steam, and that tolerably easy, by using the power of steam rushing into a vacuum, at present lost. This would do little more than double the effect, but it would too much enlarge the vessels to use it all : it is peculiarly applicable to wheel-engines, and may supply the want of a condenser, where the force of steam only is used ; for open one of the steam-valves, and admit steam until one fourth of the distance between it and the next valve is filled with steam, then shut the valve, and the steam will continue to expand, and to press round the wheel, with a diminishing power, ending in one fourth of its first exertion. The sum of the series you will find greater than one half, though only one fourth of steam was used. The power will indeed be unequal, but this can be remedied by a fly, or by several other means.”

In 1776, the engine, which had been then recently erected at Soho, was adapted to act upon the principle of expansion. When the piston had been pressed down in the cylinder for a certain portion of the stroke, the further supply of steam from the boiler was cut off, by closing the upper steam-valve, and the remainder of the stroke was accomplished by the expansive power of the steam which had already been introduced into the cylinder.

To make this method of applying the force of steam intelligible, some previous explanation of mechanical principles will be necessary.

If a body which offers a certain resistance be urged by a certain moving force, the motion which it will receive will depend on the relation between the energy of the moving force and the amount of the resistance opposed to it. If the moving force be precisely equal to the resistance, the motion which the body will receive will be perfectly uniform.

If the energy of the moving force be greater than the resistance, then its surplus or excess above the amount of resistance will be expended in imparting momentum to the mass of the body moved, and the latter will consequently continually acquire augmented speed. The motion of the body will therefore be in this case accelerated.

If the energy of the moving force be less in amount than the resistance, then all that portion of the resistance which exceeds the amount of the moving force will be expended in depriving the mass of the body of momentum, and the body will therefore be moved with continually diminished speed until it be brought to rest.

Whenever, therefore, a uniform motion is produced in a body, it may be taken as an indication of the equality of the moving force to the resistance ; and, on the other hand, according as the speed of the body is augmented or diminished, it may be inferred that the energy of the moving force has been greater or less than the resistance.

It is an error to suppose that rest is the only condition possible for a body to assume when under the operation of two or more mechanical forces which

are in equilibrium. By the laws of motion the state of a body which is not under the operation of any external force must be either in a state of rest or of uniform motion. Whichever be its state, it will suffer no change if the body be brought under the operation of two or more forces which are in equilibrium; for to suppose such forces to produce any change in the state of the body, whether from rest to motion, or *vice versa*, or in the velocity of the motion which the body may have previously had, would be equivalent to a supposition that the forces applied to the body being in equilibrium were capable of producing a dynamical effect, which would be a contradiction in terms. This, though not always clearly understood by mere practical men, or by persons superficially informed, is, in fact, among the fundamental principles of mechanical science.

When the piston is at the top of the cylinder, and about to commence its motion downward, the steam acting upon it will have not only to overcome the resistance arising from the friction of the various parts of the engine, but will also have to put in motion the whole mass of matter of the piston pump-rods, pump-pistons, and the column of water in the pump-barrels. Besides imparting to this mass the momentum corresponding to the velocity with which it will be moved, it will also have to encounter the resistance due to the preponderance of the weight of the water and pump-rods over that of the steam-piston. The pressure of steam, therefore, upon the piston at the commencement of the stroke must, in accordance with the mechanical principles just explained, have a greater force than is equal to all the resistances which it would have to overcome, supposing the mass to be moving at a uniform velocity. The moving force, therefore, being greater than the resistance, the mass, when put in motion, will necessarily move with a gradually-augmented speed, and the piston of the engine which has been already described would necessarily move from the top to the bottom of the cylinder with an accelerated motion, having at the moment of its arrival at the bottom a greater velocity than at any other part of the stroke. As the piston and all the matter which it has put in motion must at this point come to rest, the momentum of the moving mass must necessarily expend itself on some part of the machinery, and would be so much mechanical force lost. It is evident, therefore, independently of any consideration of the expansive principle, to which we shall presently refer, that the action of the moving power in the descent of the piston ought to be suspended before the arrival of the piston at the bottom of the cylinder, in order to allow the momentum of the mass which is in motion to expend itself, and to allow the piston to come gradually to rest at the termination of the stroke.

Thus, if we were to suppose that after the piston had descended through three fourths of the whole length of the cylinder, and had acquired a certain velocity, the steam above it were suddenly condensed, so as to leave a vacuum both above and below it, the piston, being then subject to no impelling force, would still move downward, in virtue of the momentum it had acquired, until the resistance would deprive it of that momentum, and bring it to rest; and if the remaining fourth part of the cylinder were necessary for the accomplishment of this, then it is evident that that part of the stroke would be accomplished without further expenditure of the moving power.

In fact, this part of the stroke would be made by the expenditure of that excess of moving power, which, at the commencement of the stroke, had been employed in putting the machinery and its load in motion, and in subsequently accelerating that motion.

Although under such circumstances the resistance, during the operation of the moving power, shall not have been at any time equal to the moving pow-

er, since while the motion was accelerated it was less, and while retarded greater, than that power, yet as the whole moving power has been expended upon the resistance, the mechanical effect which the moving power has produced under such circumstances will be equal to the actual amount of that power. If in an engine of this kind the steam was not cut off till the conclusion of the stroke, a part of the moving power would be lost upon those fixed points in the machinery which would sustain the shock produced by the instantaneous cessation of motion at the end of the stroke.

Independently, therefore, of any consideration of the expansive principle, it appears that, in an engine of this kind, the steam ought to be cut off before the completion of the stroke.

To render the expansive action of steam intelligible, let A B, fig. 12, repre-

Fig. 12.

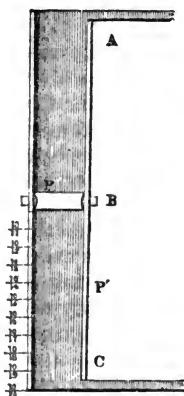

sent a cylinder whose area we will suppose, for the sake of illustration, to be a square foot, and whose length, A B, shall also be a foot. If steam of a pressure equal to the atmosphere be supplied to this cylinder, it will exert a pressure of about one ton on the piston; and if such steam be uniformly supplied from the boiler, the piston will be moved from A to B with the force of one ton, and that motion will be uniform if the piston be opposed throughout the same space by a resistance equal to a ton. When the piston has arrived at B, let us suppose that the further supply of steam from the boiler is stopped by closing the upper steam-valve, and let us also suppose the cylinder to be continued downward so that B C shall be equal to A B, and suppose that B C has been previously in communication with the condenser, and is therefore a vacuum. The piston at B will then be urged with a force of one ton downward, and as it descends the steam above it will be diffused through an increased volume, and will consequently acquire a diminished pressure. We shall, for the present, assume that this diminution of pressure follows the law of elastic fluids in general; that it will be decreased in the same proportion as the volume of the steam is augmented. While the piston, therefore, moves from B downward, it will be urged by a continually-decreasing force. Let us suppose, that, by some expedient, it is also subject to a continually-decreasing resistance, and that this resistance decreases in the same proportion as the force which urges the piston. In that case the motion of the piston would continue uniform. When the piston would arrive at P', the middle of the second cylinder, then the spaces occupied by the steam being increased in the proportion of 2 to 3, the pressure on the piston would be diminished in the

proportion of 3 to 2, and the pressure at B being one ton, it would be two thirds of a ton at P'. In like manner when the piston would arrive at C, the space occupied by the steam being double that which it occupied when the piston was at B, the pressure of the steam would be half its pressure at B, and therefore at the termination of the stroke, the pressure on the piston would be half a ton.

If the space from B to C, through which the steam is here supposed to act expansively, be divided into ten equal parts, the pressure on the piston at the moment of passing each of those divisions would be calculated upon the same principle as in the cases now mentioned. After moving through the first division, the volume of the steam would be increased in the proportion of 10 to 11, and therefore its pressure would be diminished in the proportion of 11 to 10. The pressure, therefore, driving the piston at the end of the first of these ten divisions would be $\frac{10}{11}$ ths of a ton. In like manner, its pressure at the second of the divisions would be $\frac{10}{12}$ ths of a ton, and the third $\frac{10}{13}$ ths of a ton; and so on, as indicated in the figure.

Now if the pressure of the steam through each of these divisions were to continue uniform, and, instead of gradually diminishing, to suffer a sudden change in passing from one division to another, then the mechanical effect produced from B to C would be obtained by taking a mean or average of the several pressures throughout each of the ten divisions. In the present case it has been supposed that the force on the piston at B was 2,240 pounds. To obtain the pressure in pounds corresponding to each of the successive divisions, it will therefore only be necessary to multiply 2,240 by 10, and to divide it successively by 11, 12, 13, &c. The pressures, therefore, in pounds, at each of the ten divisions, will be as follows:—

1st.....	2,036·3
2d.....	1,866·6
3d.....	1,723·1
4th.....	1,600·0
5th.....	1,493·3
6th.....	1,400·0
7th.....	1,317·6
8th.....	1,244·4
9th.....	1,179·0
10th.....	1,120·0

If the mean of these be taken by adding them together and dividing by 10, it will be found to be 1,498 pounds. It appears, therefore, that the pressures through each of the ten divisions being supposed to be uniform (which, however, strictly, they are not), the mechanical effect of the steam from B to C would be the same as if it acted uniformly throughout that space upon the piston with a force of about 1,500 pounds, being rather less than three fourths of its whole effect from A to B.

But it is evident that this principle will be equally applicable if the second cylinder had any other proportion to the first. Thus it might be twice the length of the first; and in that case, a further mechanical effect would be obtained from the expansion of the steam.

The more accurate method of calculating the effect of the expansion from B to C, would involve more advanced mathematical principles than could properly be introduced here; but the result of such a computation would be that the actual average effect of the steam from B to C would be equal to a uniform pressure through that space, amounting to one thousand five hundred and forty-five pounds, being greater than the result of the above computation, the differ-

ence being due to the expansive action through each of the ten divisions, which was omitted in the above computation.

It is evident that the expansive principle, as here explained, involves the condition of a variation in the intensity of the moving power. Thus, if the steam act with a uniform energy on the piston so long as its supply from the boiler continues, the moment that supply is stopped, by closing the steam-valve, the steam contained in the cylinder will fill a gradually-increasing volume by the motion of the piston, and therefore will act above the piston with a gradually-decreasing energy. If the resistance to the moving power produced by the load, friction, &c., be not subject to a variation corresponding precisely to such variation in the moving power, then the consequence must be that the motion imparted to the load will cease to be uniform. If the energy of the moving power at any part of the stroke be greater than the resistance, the motion produced will be accelerated; if it be less, the motion will be retarded; and if it be at one time greater, and another time less, as will probably happen, then the motion will be alternately accelerated and retarded. This variation in the speed of the body moved will not, however, affect the mechanical effect produced by the power, provided that the momentum imparted to the moving mass be allowed to expend itself at the end of the stroke, so that the piston may be brought to rest as nearly as possible by the resistance of the load, and not by any shock on any fixed points in the machine. This is an object which, consequently, should be aimed at with a view to the economy of power, independently of other considerations connected with the wear and tear of the machinery. So long as the engine is only applied to the operation of pumping water, great regularity of motion is not essential, and, therefore, the variation of speed which appears to be an almost inevitable consequence of any extensive application of the expansive principle, is of little importance. In the patent which Watt took out for the application of the expansive principle, he specified several methods of producing a uniform effect upon a uniform resistance, notwithstanding the variation of the energy of the power which necessarily attended the expansion of the steam. This he proposed to accomplish by various mechanical means, some of which had been previously applied to the equalization of a varying power. One consisted in causing the piston to act on a lever, which should have an arm of variable length, the length increasing in the same proportion as the energy of the moving power diminished. This was an expedient which had been already applied in mechanics for the purpose of equalizing a varying power. A well-known example of it is presented in the mainspring and fuzee of a watch. According as the watch goes down, the mainspring becomes relaxed, and its force is diminished; but, at the same time, the chain by which it drives the fuzee acts upon a wheel or circle, having a diameter increased in the same proportion as the energy of the spring is diminished.

Another expedient consisted in causing the moving power, when acting with greatest energy, to lift a weight which should be allowed to descend again, assisting the piston when the energy of the moving force was diminished.

Another method consisted in causing the moving force, when acting with greatest energy, to impart momentum to a mass of inert matter, which should be made to restore the same force when the moving power was more enfeebled. We shall not more than allude here to these contrivances proposed by Watt, since their application has never been found advantageous in cases where the expansive principle is used.

The application of the expansive principle in the engines constructed by Boulton and Watt, was always very limited, by reason of their confining themselves to the use of steam having a pressure not much exceeding that of the

atmosphere. If the principle of expansion, as above explained, be attentively considered, it will be evident that the extent of its application will mainly depend on the density and pressure of the steam admitted from the boiler. If the density and pressure be not considerable when the steam is cut off, the extent of its subsequent expansion will be proportionally limited. It was in consequence of this, that this principle from which considerable economy of power has been derived, was applied with much less advantage by Mr. Watt than it has since been by others, who have adopted the use of steam of much higher pressure. In the engines of Boulton and Watt, where the expansive principle was applied, the steam was cut off after the piston had performed from one half to two thirds of the stroke, according to the circumstances under which the engine was worked. The decreasing pressure produced by expansion was, in this case, especially with the larger class of engines, little more than would be necessary to allow the momentum of the mass moved to spend itself, before the arrival of the piston at the end of the stroke.

Subsequently, however, boilers producing steam of much higher pressure were applied, and the steam was cut off when the piston had performed a much smaller part of the whole stroke. The great theatre of these experiments and improvements has been the mining districts in Cornwall, where, instead of working with steam of a pressure not much exceeding that of the atmosphere, it has been found advantageous to use steam whose pressure is at least four times as great as that of the atmosphere; and instead of limiting its expansion to the last half or fourth of the stroke, it is cut off after the piston has performed one fourth part of the stroke or less, all the remainder of the stroke being accomplished by the expansive power of the steam, and by momentum.

For several years after the extension of Watt's first patent had been obtained from parliament, he was altogether engrossed by the labor of bringing to perfection the application of the steam-engine to the drainage of mines, and in surmounting the numerous difficulties which presented themselves to its general adoption, even after its manifold advantages were established and admitted. When, however, these obstacles had been overcome, and the works for the manufacture of engines for pumping water, at Soho, had been organized and brought into active operation, he was relieved from the pressure of these anxieties, and was enabled to turn his attention to the far more extensive and important uses of which he had long been impressed with the conviction that the engine was capable. His sagacious mind enabled him to perceive that the machine he had created was an infant force, which by the fostering influence of his own genius would one day extend its vast power over the arts and manufactures, the commerce and the civilization of the world. Filled with such aspirations, he addressed his attention about the year 1779, to the adaptation of the steam-engine to move machinery, and thereby to supersede animal power, and the natural agents, wind and water.

The idea that steam was capable of being applied extensively as a prime mover, had prevailed from a very early period; and now that we have seen its powers so extensively brought to bear, it will not be uninteresting to revert to the faint traces by which its agency was sketched in the crude speculations of the early mechanical inventors.

Papin, to whom the credit of discovering the method of producing a vacuum by the condensation of steam is due, was the earliest and most remarkable of those projectors. With very limited powers of practical application, he was, nevertheless, peculiarly happy in his mechanical conceptions; and had his experience and opportunities been proportionate to the clear-sighted character of his mind, he would doubtless have anticipated some of the most memorable of his successors in the progressive improvement of the steam-engine.

In his work, after describing his method of imparting an alternate motion to a piston by the atmospheric pressure acting against a vacuum produced by the condensation of steam, he stated that his invention, besides being applicable to pumping water, could be available for rowing vessels against wind and tide, which he proposed to accomplish in the following manner:—

Paddle-wheels, such as have since been brought into general use, were to be placed at the sides, and attached to a shaft extending across the vessel. Within the vessel, and under this shaft, he proposed to place several cylinders supplied with pistons, to be worked by the atmospheric pressure. On the piston-rods were to be constructed racks furnished with teeth; these teeth were to work in the teeth of wheels or pinions, placed on the shaft of the paddle-wheels. These pinions were not to be fixed on the shaft, but to be connected with it by a ratchet; so that when they turned in one direction, they would revolve without causing the shaft to revolve; but when driven in the other direction, the catch of the ratchet-wheel would act upon the shaft so as to compel the shaft and paddle-wheels to revolve with the motion of the pinion or wheel upon it. By this arrangement, whenever the piston of any cylinder was forced down by the atmospheric pressure, the rack descending would cause the corresponding pinion of the paddle-shaft to revolve; and the catch of the ratchet-wheel, being thus in operation, would cause the paddle-shaft and paddle-wheels also to revolve; but whenever the piston would rise, the rack driving the pinion in the opposite direction, the catch of the ratchet-wheel would merely fall from tooth to tooth, without driving the paddle-shaft.

It is evident that by such an arrangement a single cylinder and piston would give an intermitting motion to the paddle-shaft, the motion of the wheel being continued only during the descent of the piston; but if several cylinders were provided, then their motion might be so managed, that when one would be performing its ascending stroke, and therefore giving no motion to the paddle-shaft, another should be performing its descending stroke, and therefore driving the paddle-shaft. As the interval between the arrival of the piston at the bottom of the cylinder and the commencement of its next descent would have been, in the imperfect machine conceived by Papin, much longer than the time of the descent, it was evident that more than two cylinders would be necessary to insure a constantly-acting force on the paddle-shaft, and, accordingly, Papin proposed to use several cylinders.

In addition to this, Papin proposed to construct a boiler having a fireplace surrounded on every side by water, so that the heat might be imparted to the water with such increased rapidity as to enable the piston to make four strokes per minute. These projects were promulgated in 1690, but it does not appear that they were ever reduced to experiment.

Savery proposed, in his original patent, in 1698, to apply his steam-engine as a general prime mover for all sorts of machinery, by causing it to raise water to make an artificial fall, by which overshot water-wheels might be driven. This proposal was not acted on during the lifetime of Savery, but it was at a subsequent period partially carried into effect. Mr. Joshua Rigley erected several steam-engines on this principle at Manchester, and other parts of Lancashire, to impel the machinery of some of the earliest manufactories and cotton mills in that district. The engines usually raised the water from sixteen to twenty feet high, whence it was conveyed to an overshot wheel, to which it gave motion. The same water was repeatedly elevated by the engine, so that no other supply was necessary, save what was sufficient to make good the waste. These engines continued in use for some years, until superseded by improved machines.*

* Farey, Treatise on the Steam-Engine, p. 122.

In 1736, Jonathan Hulls obtained a patent for a method of towing ships into or out of harbor against wind and tide. This method was little more than a revival of that proposed by Papin in 1690. The motion, however, was to be communicated to the paddle-shaft by a rope passing over a pulley fixed on an axis, and was to be maintained during the returning stroke of the piston by the descent of a weight which was elevated during the descending stroke. There is no record, however, of this plan, any more than that of Papin, ever having been reduced to experiment.

During the early part of the last century the manufactures of this country had not attained to such an extent as to render the moving power supplied by water insufficient or uncertain to any inconvenient degree; and accordingly mills, and other works in which machinery required to be driven by a moving power, were usually built along the streams of rivers. About the year 1750 the general extension of manufactures, and their establishment in localities where water power was not accessible, called the steam-engine into more extensive operation. In the year 1752, Mr. Champion, of Bristol, applied the atmospheric engine to raise water, by which a number of overshot wheels were driven. These were applied to move extensive brass-works in that neighborhood, and this application was continued for about twenty years, but ultimately given up on account of the expense of fuel and the improved applications of the steam-engine.

About this time Smeaton applied himself with great activity and success to the improvement of wind and water mills, and succeeded in augmenting their useful effect in a twofold proportion with the same supply of water. From the year 1750 until the year 1780 he was engaged in the construction of his improved water-mills, which he erected in various parts of the country, and which were imitated so extensively that the improvement of such mills became general. In cases where a summer drought suspended the supply of water, horse machinery was provided, either to work the mill or to throw back the water. These improvements necessarily obstructed for a time the extension of steam power to millwork; but the increase of manufactures soon created a demand for power greatly exceeding what could be supplied by such limited means.

In the manufacture of iron, it is of great importance to keep the furnaces continually blown, so that the heat may never be abated by day or night. In the extensive iron-works at Colebrook Dale, several water-wheels were used in the different operations of the manufacture of iron, especially in driving the blowers of the iron furnaces. These wheels were usually driven by the water of a river, but in the summer months the supply became so short that it was insufficient to work them all. Steam-engines were accordingly erected to return the water for driving these wheels. This application of the engine as an occasional power for the supply of water-wheels having been found so effectual, returning engines were soon adopted as the permanent and regular means of supplying water-wheels. The first attempt of this kind is recorded to have been made by Mr. Oxley, in 1762, who constructed a machine to draw coals out of a pit at Hartley colliery, in Northumberland. It was originally intended to turn the machine by a continuous circular motion received from the beam of the engine; but that method not being successful, the engine was applied to raise water for a wheel by which the machine was worked. This engine was continued in use for several years, and though it was at length abandoned, on account of its defective construction, it nevertheless established the practicability of using steam power as a means of driving water-wheels.*

In the year 1777, Mr. John Stewart read a paper before the royal society, describing a method for obtaining a continued circular motion for turning all

* Farey on the Steam-Engine, p. 297.

kinds of mills from the reciprocating motion of a steam-engine. He proposed to accomplish this by means of two endless chains passing over pulleys, which should be moved upward and downward by the motion of the engine, in the manner of a window-sash. The joint pins of the links of the two chains worked in teeth at the opposite sides of a cog-wheel, to which they imparted a circular motion, first by one chain, and then by the other, acting alternately on opposite sides of the wheel. One chain impelled it during the descent of the piston, and the other during the ascent; but one of these chains always passed over its pulleys so as to produce no effect on one side of the cog-wheel, while the other chain worked on the opposite side to turn it round. For this purpose each chain was provided with a catch, to prevent its circulating over its pulleys in one direction, but to allow it free motion in the other. The cog-wheel thus kept in revolution might be applied to the axis of any mill which the engine was required to work. Thus, if it were applied to a flour-mill, the millstone itself would perform the office of a fly-wheel to regulate the intermission of the power, and in other mills a fly-wheel might be added for this purpose.

The hints obtained by Mr. Stewart from Papin's contrivance, before mentioned, will not fail to be perceived. In Mr. Stewart's paper he notices indirectly the method of obtaining a continued circular motion from a reciprocating motion by means of a crank or winch, which, he says, occurs naturally in theory, but in practice would be impossible, from the nature of the motion of the engine, which depends on the force of the steam, and cannot be ascertained in its length. Therefore, on the first variation, the machine would be either broken in pieces or turned back. Such an opinion, pronounced by a man of considerable mechanical knowledge and ingenuity, against a contrivance which, as will presently appear, proved in practice, not less than in theory, to be the most effectual means of accomplishing the end here pronounced to be impossible, is sufficiently remarkable. It might cast some doubt on the extent of Mr. Stewart's practical knowledge, if it did not happen to be in accordance with a judgment so generally unimpeachable as that of Mr. Smeaton. This paper of Mr. Stewart's was referred by the council of the royal society to Mr. Smeaton, who remarked upon the difficulty arising from the absolute stopping of the whole mass of moving power, whenever the direction of the motion is changed; and observed, that although a fly-wheel might be applied to regulate the motion, it must be such a large one as would not be readily controlled by the engine itself; and he considered that the use of such a fly-wheel would be a greater incumbrance to a mill than a water-wheel to be supplied by water pumped up by the engine. This engineer, illustrious as he was, not only fell into the error of Mr. Stewart in respect of the crank, but committed the further blunder of condemning the very expedient which has since rendered the crank effectual. It will presently appear that the combination of the crank and fly-wheel have been the chief means of establishing the dominion of the steam-engine over manufactures.

In 1779, Mr. Matthew Wasbrough, an engineer at Bristol, took out a patent for the application of a steam-engine to produce a continuous circular motion by means of ratchet-wheels, similar to those previously used by Mr. Oxley, at Hartley colliery; to which, however, Mr. Wasbrough added a fly-wheel to maintain and regulate the motion. Several machines were constructed under this patent; and among others, one was erected at Mr. Taylor's saw-mills and block manufactory at Southampton. In 1780, one was erected at Birmingham, where the ratchet-work was found to be subject to such objections, that one of the persons about the works substituted for it the simple crank, which has since been invariably used. A patent was taken out for this application of the

crank in the same year, by Mr. James Pickard, of Birmingham. It will presently appear, however, that the suggestion of this application of the crank was derived from the proceedings of Watt, who was at the same time engaged in similar experiments.

The single-acting steam-engine, as constructed by Watt, was not adapted to produce continuous uniform motion of rotation, for the following reasons:—

First. The effect required was that of a uniformly-acting force. The steam-engine, on the other hand, supplied an intermitting force. Its operation was continued during the descending motion of the piston, but it was suspended during the ascent of the piston. To produce the continued effect now required, either its principle of operation should be altered, or some expedient should be devised for maintaining the motion of the revolving shaft during the ascent of the piston, and the consequent suspension of the moving power.

Secondly. The action of the steam-engine was rectilinear. It was a power which acted in a straight line, viz., in the direction of the cylinder. The motion, however, required to be produced, was a circular motion—a motion of rotation around the axis or shaft of the mill.

The steps by which Watt proceeded to accomplish these objects have been recorded by himself as follows, in his notes upon Dr. Robinson's article on the steam-engine:—

“I had very early turned my mind to the producing of continued motion round an axis; and it will be seen, by reference to my first specification in 1769, that I there described a steam-wheel, moved by the force of steam, acting in a circular channel against a valve on one side, and against a column of mercury, or some other fluid metal, on the other side. This was executed upon a scale of about six feet diameter at Soho, and worked repeatedly, but was given up, as several practical objections were found to operate against it; similar objections lay against other rotative engines, which had been contrived by myself and others, as well as to the engines producing rotatory motions by means of ratchet-wheels.

“Having made my single reciprocating engines very regular in their movements, I considered how to produce rotative motions from them in the best manner; and among various schemes which were subjected to trial, or which passed through my mind, none appeared so likely to answer the purpose as the application of the crank, in the manner of the common turning lathe; but as the rotative motion is produced in that machine by impulse given to the crank in the descent of the foot only, it requires to be continued in its ascent by the energy of the wheel, which acts as a fly; being unwilling to load my engines with a fly-wheel heavy enough to continue the motion during the ascent of the piston (or with a fly-wheel heavy enough to equalize the motion, even if a counterweight were employed to act during that ascent), I proposed to employ two engines, acting upon two cranks fixed on the same axis, at an angle of 120° to one another, and a weight placed upon the circumference of the fly-wheel at the same angle to each of the cranks, by which means the motion might be rendered nearly equal, and only a very light fly-wheel would be requisite.

“This had occurred to me very early; but my attention being fully employed in making and erecting engines for raising water, it remained *in petto* until about the year 1778 or 1779, when Mr. Wasbrough erected one of his ratchet-wheel engines at Birmingham, the frequent breakages and irregularities of which recalled the subject to my mind, and I proceeded to make a model of my method, which answered my expectations; but having neglected to take out a patent, the invention was communicated by a workman employed to make the model, to some of the people about Mr. Wasbrough's engine, and a

patent was taken out by them for the application of the crank to steam-engines. This fact the said workman confessed, and the engineer who directed the works acknowledged it; but said, nevertheless, that the same idea had occurred to him prior to his hearing of mine, and that he had even made a model of it before that time; which might be a fact, as the application to a single crank was sufficiently obvious.

"In these circumstances, I thought it better to endeavor to accomplish the same end by other means, than to enter into litigation; and if successful, by demolishing the patent, to lay the matter open to everybody. Accordingly, in 1781, I invented and took out a patent for several methods of producing rotative motions from reciprocating ones; among which was the method of the sun-and-planet wheels. This contrivance was applied to many engines, and possesses the great advantage of giving a double velocity to the fly-wheel; but is perhaps more subject to wear, and to be broken under great strains, than a simple crank, which is now more commonly used, although it requires a fly-wheel of four times the weight, if fixed upon the first axis; my application of the double engine to these rotative machines rendered the counterweight unnecessary, and produced a more regular motion."

Watt's second patent here referred to, was dated 25th of October, 1781, and was entitled, "A patent for certain new methods of applying the vibrating or reciprocating motions of steam or fire engines to produce a continued rotative or circular motion round an axis or centre, and thereby to give motion to the wheels of mills and other machines."

All the methods specified in this patent were intended to be worked by the single-acting engine, already described, a counterweight being applied to impel the machinery during the returning stroke of the engine, which weight would be elevated during the descent of the piston. There were five different expedients proposed in the specification for producing a rotatory motion; but, of these five, two only were ever applied in practice.

Suppose a rod or bar attached by a pin or joint at the upper extremity to the working end of the beam of the engine, and by a similar pin or joint at the lower extremity to an iron wheel fixed on the extremity of the axis of the fly-wheel. One half of this wheel is formed of a solid semicircle of cast iron, while the other half is constructed of open spokes, so as to be as light as is consistent with strength. The position of the wheel on the axis is such that during the returning stroke of the piston, when the operation of the steam is suspended, the heavy semicircle of the wheel will be descending, and by its weight will draw down the connecting bar, and thereby draw down the working end of the beam, and draw up the piston in the cylinder. When the piston descends and is driven by the power of the steam, the heavy semicircle of the above-mentioned wheel will be drawn upward, and in the same way the motion will be continued.

The second method of producing a rotatory motion, which was subsequently continued for many years in practical operation, was that which was called the *sun-and-planet wheels*. A toothed wheel, A, fig. 13, called the sun-wheel, was fixed on the axle of the fly-wheel, to which rotation was to be imparted. The wheel B, called the planet-wheel, having an equal diameter, was fastened on the end I of the connecting rod H I, so as to be incapable of revolving. During the descent of the piston, the working end of the beam was drawn upward, and the end I of the connecting rod travelled from C to D, through the dotted semicircle C I D. The wheel B not being capable of revolving on the centre I, would, during this motion, drive the sun-wheel A. During the ascent of the steam-piston, the working end of the beam would descend, and the centre I of the planet-wheel B would be driven downward from D to C,

Fig. 13.

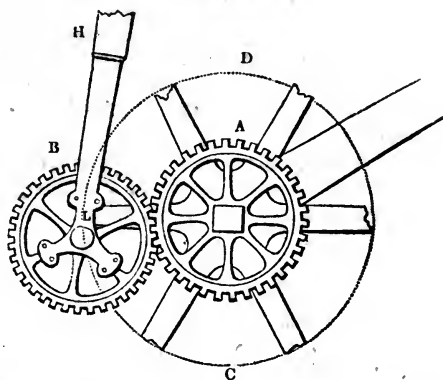

through the other dotted semicircle, and would consequently continue to drive the sun-wheel round in the same direction.

This contrivance, although in the main inferior to the more simple one of the crank, is not without some advantages; among others, it gives to the sun-wheel double the velocity which would be communicated by the crank; for in the crank one revolution only on the axle is produced by one revolution of the crank, but in the sun-and-planet wheels, two revolutions of the sun-wheel are produced by one of the planet-wheel; thus a double velocity is obtained from the same motion of the beam. This will be evident from considering that when the planet-wheel is in its highest position, its lowest tooth is engaged with the highest tooth of the sun-wheel; as the planet-wheel passes from the highest position, its teeth drive those of the sun-wheel before them, and when it comes into the lowest position, the highest tooth of the planet-wheel is engaged with the lowest of the sun-wheel: but then half of the sun-wheel has *rolled off* the planet-wheel, and, therefore, the tooth which was engaged with it in its highest position, must now be distant from it by half the circumference of the wheel, and must, therefore, be again in the highest position; so that while the planet-wheel has been carried from the top to the bottom, the sun-wheel has made a complete revolution.

This advantage of giving an increased velocity may be obtained also by the crank, by placing toothed wheels on its axle. Independently of the greater expense attending the construction of the sun-and-planet wheel, its liability to go out of order, and the rapid wear of the teeth, and other objections, rendered it inferior to the crank, which has entirely superseded it.

Although by these contrivances Watt succeeded in obtaining a continuous circular motion from the reciprocating motion of the steam-engine, the machine was still one of intermitting, instead of continuous action. The expedient of a counterweight, elevated during the descending stroke, and giving back the power expended on it in the interval of the returning stroke, did not satisfy the fastidious mechanical taste of Watt. He soon perceived that all which he proposed to accomplish by the application of two cylinders and pistons working alternately, could be attained with greater simplicity and effect by a single cylinder, if he could devise means by which the piston might be impelled by steam upward as well as downward. To accomplish this, it was only necessary to throw the lower end of the cylinder into alternate communication with the boiler, while the upper end would be put into communication with the condenser. If, for example, during the descent of the piston, the upper end of the cylinder communicated with the boiler, and the lower end with the

condenser; and, on the other hand, during the ascent of the piston, the lower end communicated with the boiler, and the upper end with the condenser; then the piston would be driven continually, whether upward or downward, by the power of steam acting against a vacuum. Watt obtained his third patent for this contrivance, on the 12th of March, 1782.

This change in the principle of the machine involved several other changes in the details of its mechanism.

It was necessary, in the first place, to provide means for admitting and withdrawing the steam at either end of the cylinder. For this purpose let B and B' fig. 14, be two steam-boxes, B the upper, and B' the lower, communicating

Fig. 14.

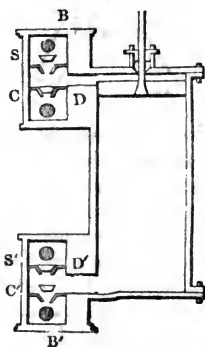

respectively with the top and bottom of the cylinder by proper passages D D'. Let two valves be placed in B, one, S, above the passage D, and the other, C, below it; and in like manner two other valves in the lower valve-box, B', one, S', above the passage D', and the other, C', below it. Above the valve S in the upper steam-box is an opening at which the steam-pipe from the boiler enters, and below the valve C is another opening, at which enters the exhausting-pipe leading, to the condenser. In like manner, above the valve S' in the lower steam-box enters a steam-pipe leading from the boiler, and below the valve C' enters an exhausting-pipe leading to the condenser. It is evident, therefore, that steam can always be admitted above the piston by opening the valve S, and below it by opening the valve S'; and, in like manner, steam can be withdrawn from the cylinder above the piston, and allowed to pass to the condenser, by opening the valve C, and from below it by opening the valve C'.

Supposing the piston P to be at the top of the cylinder, and the cylinder below the piston to be filled with pure steam, let the valves S and C' be opened, the valves C and S' being closed as represented in fig. 15. Steam from the boiler will, therefore, flow in through the open valve S, and will press the piston downward, while the steam that has filled the cylinder below the piston will pass through the open valve C' into the exhausting-pipe leading to the condenser, and being condensed will leave the cylinder below the piston a vacuum. The piston will, therefore, be pressed downward by the action of the steam above it, as in the single-acting engine. Having arrived at the bottom of the cylinder, let the valves S and C' be both closed, and the valves S' and C be opened, as represented in fig. 15. Steam will now be admitted through the open valve S' and through the passage D' below the piston, while the steam which has just driven the piston downward, filling the cylinder above the piston, will be drawn off through the open valve C, and the exhausting-pipe, into the condenser, leaving the cylinder above the piston a vacuum.

Fig. 15.

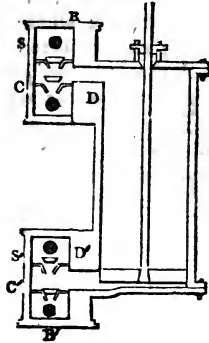

The piston will, therefore, be pressed upward by the action of the steam below it, against the vacuum above it, and will ascend with the same force as that with which it had descended.

This alternate action of the piston upward and downward may evidently be continued by opening and closing the valves alternately in pairs. Whenever the piston is at the top of the cylinder, as represented in fig. 14, the valves *S* and *C'*, that is, the upper steam-valve and the lower exhausting-valve, are opened, and the valves *C* and *S'*, that is, the upper exhausting-valve and the lower steam-valve, are closed; and when the piston has arrived at the bottom of the cylinder, as represented in fig. 15, the valves *C* and *S'*, that is, the upper exhausting-valve and the lower steam-valve, are opened, and the valves *S* and *C'*, that is, the upper steam-valve and the lower exhausting-valve, are closed.

If these valves, as has been here supposed, be opened and closed at the moments at which the piston reaches the top and bottom of the cylinder, it is evident that they may be all worked by a single lever connected with them by proper mechanism. When the piston arrives at the top of the cylinder, this lever would be made to open the valves *S* and *C'*, and at the same time to close the valves *S'* and *C*; and when it arrives at the bottom of the cylinder, it would be made to close the valves *S* and *C'*, and to open the valves *S'* and *C*.

If, however, it be desired to cut off the steam before the arrival of the piston at the termination of its stroke, whether upward or downward, then the steam-valves must be closed before the arrival of the piston at the end of its stroke; and as the exhausting-valve ought to be left open until the stroke is completed, these valves ought to be moved at different times. In that case separate levers should be provided for the different valves. We shall, however, return again to the subject of the valves which regulate the admission of steam to the cylinder and its escape to the condenser.

It will be remembered that in the single-acting engine the process of condensation was suspended while the piston ascended in the cylinder, and therefore the play of the jet of cold water in the condenser was stopped during this interval. In the double-acting engine, however, the flow of steam from the cylinder to the condenser is continued, whether the piston ascend or descend, and therefore a constant condensation of steam must be produced. The condensing jet, therefore, does not in this case, as in the former, play with intervals of intermission. A constant jet of cold water must be maintained in the condenser.

It will presently appear that in the double-acting engine applied to manu-

factures, the motion of the piston was subject to more or less variation of speed, and the quantity of steam admitted to the cylinder was subject to a corresponding change. The quantity of steam, therefore, drawn into the condenser was subject to variation, and required a considerable change in the quantity of cold water admitted through the jet to condense it. To regulate this, the valve or cock by which the water was admitted into the condenser was worked in the double-acting engine by a lever furnished with an index, by which the quantity of condensing water admitted into the condenser could be regulated. This index played upon a graduated arch, by which the engineer was enabled to regulate the supply.

THE STEAM-ENGINE.

(THIRD LECTURE.)

Methods of Connecting the Piston-Rod and Beam in the Double-acting Engine.—Rack and Sector.—Parallel Motion.—Connexion of Piston-Rod and Beam.—Connecting Rod and Crank.—Fly-Wheel.—Throttle-Valve.—Governor.—Construction and Operation of the Double-acting Engine.—Eccentric.—Cocks and Valves.—Single-Clack Valves.—Double-Clack Valves.—Conical Valves.—Slide Valves.—Murray's Slides.—The D Valves.—Seaward's Slides.—Single Cock.—Two-way Cock.—Four-way Cock.—Pistons.—Common Hemp-packed Piston.—Woolf's Piston.—Metallic Pistons.—Cartwright's Engine.—Cartwright's Piston.—Barton's Piston.

THE HISTORY OF THE

of the
of the
of the
of the
of the
of the

THE STEAM-ENGINE.

(THIRD LECTURE.)

IN the single-acting engine, the force of the piston acted on the beam only during its descent; and this force was transmitted from the piston to the beam, as we have seen, by a flexible chain, extended from the end of the piston-rod, and playing upon the arch head of the beam. In the double-acting engine, however, the force of the steam pressing the piston upward must likewise be transmitted to the beam, so as to drive the latter upward while the piston ascends. This action could not be accomplished by a chain connecting the piston with the arch head of the beam.

Where the mechanical action to be transmitted is a *pull*, and not a *push*, a flexible chain, cord, or strap, is sufficient; but if a *push* or *thrust* is required to be transmitted, then the flexibility of the medium of mechanical communication afforded by a chain renders it inapplicable. In the double-acting engine, during the descent, the piston-rod still pulls the beam down; and so far a chain connecting the piston-rod with the beam would be sufficient to transmit the action of the one to the other; but in the ascent the beam no longer pulls up the piston-rod, but is pushed up by it. A chain from the piston-rod to the arch head, as described in the single-acting engine, would fail to transmit this force. If such a chain were used with the double engine, where there is no counter-weight on the opposite end of the beam, the consequence would be, that in the ascent of the piston the chain would slacken, and the beam would still remain depressed. It is therefore necessary that some other mechanical connexion be contrived between the piston-rod and the beam, of such a nature that in the *descent* the piston-rod may *pull* the beam down, and may *push* it up in the *ascent*.

Watt first proposed to effect this by attaching to the end of the piston-rod a straight rack, faced with teeth, which should work in corresponding teeth raised on the arch head of the beam, as represented in fig. 16. If his improved steam-engines required no further precision of operation and construc-

Fig. 16.



tion than the atmospheric engines, this might have been sufficient; but in these engines it was indispensably necessary that the piston-rod should be guided with a smooth and even motion through the stuffing-box in the top of the cylinder, otherwise any shake or irregularity would cause it to work loose in the stuffing-box, and either to admit the air, or to let the steam escape. Under these circumstances, the motion of the rack and toothed arch head were inadmissible, since it was impossible by such means to impart to the piston-rod that smooth and equable motion which was requisite. Another contrivance which occurred to Watt was, to attach to the top of the piston-rod a bar, which should extend above the beam, and to use two chains or straps, one extending from the top of the bar to the lower end of the arch head, and the other from the bottom of the bar to the upper end of the arch head. By such means the latter strap would pull the beam down when the piston would descend, and the former would pull the beam up when the piston would ascend. These contrivances, however, were superseded by the celebrated mechanism since called the *Parallel Motion*, one of the most ingenious mechanical combinations connected with the history of the steam-engine.

It will be observed that the object was to connect by some inflexible means the end of the piston-rod with the extremity of the beam, and so to contrive the mechanism, that while the end of the beam would move alternately up and down in part of a circle, the end of the piston-rod connected with the beam should move up and down in a straight line. If the end of the piston-rod were fastened upon the end of the beam by a pivot without any other connexion, it is evident that, being moved up and down in the arch of a circle, it would be drawn to the left and the right alternately, and would consequently either be broken or bent, or would work loose in the stuffing-box. Instead of connecting the end of the rod immediately with the end of the beam by a pivot, Watt proposed to connect them by certain moveable rods, so arranged that, as the end of the beam would move up and down in the circular arch, the rods would so accommodate themselves to that motion, that the end connected with the piston-rod should not be disturbed from its rectilinear course.

To explain the principle of the mechanism called the parallel motion, let us suppose that OP , fig. 17, is a rod or lever moveable on a centre O , and that the end P of this rod shall move through a circular arch $P'P''P'''$ in a vertical plane, and let its play be limited by two stops S , which shall prevent its ascent above the point P , and its descent below the point P''' . Let the position of the rod and the limitation of its play be such that the straight line AB drawn through $P'P'''$, the extreme positions of the lever OP , shall be a vertical line.

Let o be a point on the other side of the vertical line AB , and let the distance of O to the right of AB be the same as the distance of o to the left of AB . Let op be a rod equal in length to OP , moving like OP on the centre o , so that its extremity p shall play upward and downward through the arch $p'p''p'''$, its play being limited in like manner by stops s .

Fig. 17.

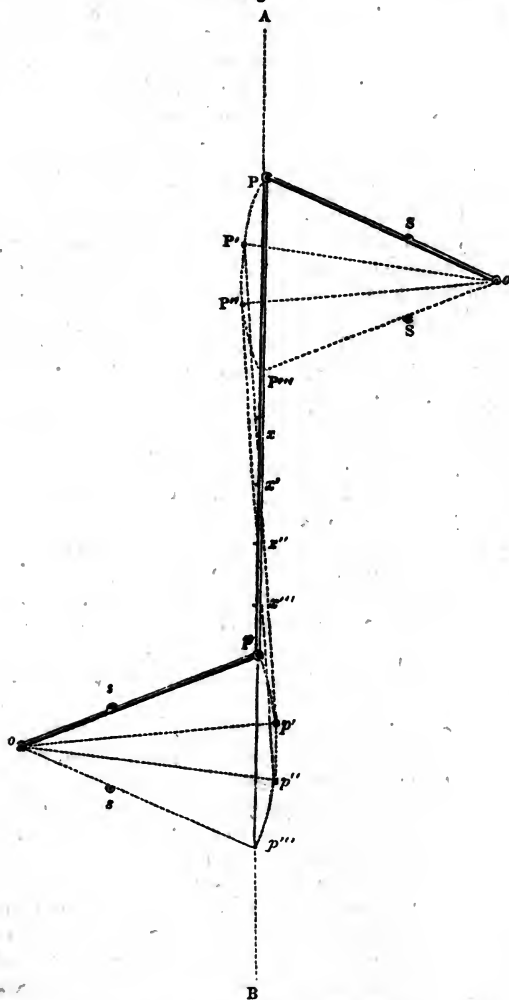

Now, let us suppose that the ends $P p$ of these two rods are joined by a link $P p$, the connexion being made by a pivot, so that the angles formed by the link and the rods shall be capable of changing their magnitude. This link will make the motion of one rod depend on that of the other, since it will preserve their extremities $P p$ always at the same distance from each other. If, therefore, we suppose the rod OP to be moved to the position OP''' , its extremity P tracing the arch $P P' P'' P'''$, the link connecting the rods will at the same time drive the extremity p of the rod Op through the arch $p p' p'' p'''$, so that when the extremity of the one rod arrives at P''' , the extremity of the other rod will arrive at p''' . By this arrangement, in the simultaneous motion of the rods, whether upward or downward, through the circular arches to which their play is limited, the extremities of the link joining them will deviate from the vertical line AB in opposite directions. At the limits of their

play, the extremities of the link will always be in the line AB ; but in all intermediate positions, the lower extremity of the link will be to the right of AB , and its upper extremity to the left of AB . So far as the derangement of the lower extremity of the link is concerned, the matter composing the link would be transferred to the right of AB ; and so far as the upper extremity of the link is concerned, the matter composing it would be transferred to the left of AB .

By the combined effects of these contrary derangements of the extremities of the link from the vertical line, it might be expected that a point would exist, in the middle of the link, where the two contrary derangements would neutralize each other, and which point would therefore be expected to be disturbed neither to the right nor to the left, but to be moved upward and downward in the vertical line AB . Such is the principle of the parallel motion; and in fact the middle point of the link will move for all practical purposes accurately in the vertical line AB , provided that the angular play of the levers OP and op does not exceed a certain limit, within which, in practice, their motion may always be restrained.

To trace the motion of the middle point of the link more minutely, let $P P' P'' P'''$ be four positions of the lever OP , and let $p p' p'' p'''$ be the four corresponding positions of the lever op . In the positions OP op , the link will take the position $P p$ in which the entire link will be vertical, and its middle point x will therefore be in the vertical line AB .

When the one rod takes the position OP' , the other rod will have the position op' ; and the link will have the position $P' p'$. The middle point of the link will be at x' , which will be found to be on the vertical line AB . Thus one half of the link $P' x'$ will be to the left of the vertical line AB ; while the other half, $p' x'$, will be to the right of the vertical line; the derangement from the vertical line affecting each half of the link in contrary directions.

Again, taking the one rod in the position OP'' , the corresponding position of the other rod will be op'' , and the position of the link will be $P'' p''$. If the middle point of the link in this position be taken, it will be found to be at x'' , on the vertical line AB ; and, as before, one half of the link $P'' x''$ will be thrown to the left of the vertical line, while the other half, $p'' x''$, will be thrown to the right of the vertical line.

Finally, let the one rod be in its lowest position, OP''' , while the other rod shall take the corresponding position, op''' . The direction of the link $P''' p'''$ will now coincide with the vertical line; and its middle point x''' will therefore be upon that line. The previous derangement of the extremities of the rod, to the right and to the left, are now redressed, and all the parts of the rod have assumed the vertical position.

It is plain, therefore, that by such means the alternate motion of a point such as P or p , upward and downward in a circular arch, may be made to produce the alternate motions of another point x , upward and downward in a straight line.

Although the guidance of the air-pump rod in a true vertical line is not so necessary as that of the steam-piston, and as the air-pump piston is always brought down by its own weight and that of its rod, the connexion of the air-pump piston-rod with the beam, by any contrivance of the kind now described, was not so necessary. Nevertheless, by a slight addition to the mechanical contrivance which has been just described, Watt obtained the means of at once preserving the true rectilinear motion of both piston-rods.

Let the lever represented by OP , in fig. 17, be conceived to be prolonged to twice its length, as represented in fig. 18, so that OP' shall be twice OP .

Fig. 18.

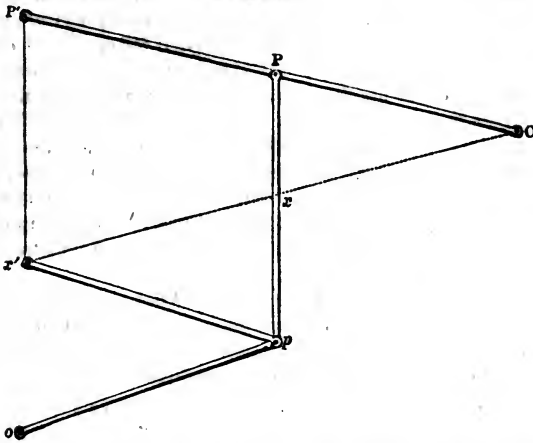

Let the points $P p$ be connected by a link, as before. Let a link $P' x'$, equal in length to the link $P p$, be attached to the point P' , and let the extremity x' of this link be connected with the point p by another link, equal in length to $P P'$, by pivots at x' and p , so that the figure $P. P' x' p$ shall be a jointed parallelogram, the angles of which will be capable of altering their magnitude with every change of position of the rods $o p$ and $O P$. Thus, when the rod $O P$ descends, the angles of the parallelogram at P and x' will be diminished in magnitude, while the angles at P' and p will be increased in magnitude. Now, let a line be conceived to be drawn from O to x' . It is evident that that line will pass through the middle point of the link $p P$, for the triangle $O P x$ is in all respects similar to the greater triangle $O P' x'$ only on half the scale, so that every side of the one is half the corresponding side of the other. Therefore $P x$ is half the length of $P' x'$; but $P' x'$ was made equal to $P p$, and therefore $p x$ is half of $P p$; that is to say, x is the middle point of $P p$.

It has been already shown, that in the alternate motion of the rods $o p, O P$, in ascending and descending, the point x is moved upward and downward in a true vertical line. Now since the triangle $O P x$ is in all respects similar to $O P' x'$, and subject to a similar motion during the ascent and descent of the rods, it is apparent that the point x' must be subject to a motion in all respects similar to that which affects the points x , except that the point x' will move through double the space. In fact, the principle of the mechanism is precisely similar to that of the common pantograph, where two rods are so connected as that the motion of the one governs the motion of the other, so that whatever line or figure may be described by one, a similar line or figure must be described by the other. Since, then, the point x is moved upward and downward in a vertical straight line, the point x' will also be moved in a vertical straight line of double the length.

If such an arrangement of mechanism as has been here described can be connected with the beam of the steam-engine, so that while the point x' is attached to the top of the steam-piston, and the space through which it ascends and descends shall be equal to the length of the stroke of that piston, the point x shall be attached to the rod of the air-pump piston, the stroke of the latter being half that of the steam-piston, then the points x' and x will guide the motion of the two pistons so as to preserve them in true vertical straight lines.

The manner in which these ideas are reduced to practice admits of easy ex-

planation : let the point o be the centre of the great working beam, and let $O P'$ be the arm of the beam on the side of the steam-cylinder. Let P be a pivot upon the beam, at the middle point between its centre O and its extremity P' ; and let the links $P p$, $P' x'$, and $P p$, be joined together, as already described. Let the point or pivot o be attached to some part of the fixed framing of the engine or engine-house, and let the rod $o p$, equal to half the arm of the beam, be attached by a pivot to the corner of the parallelogram at p . Let the end of the steam piston-rod be attached to the corner of the parallelogram x' , and let the end of the air-pump be attached to the middle point x of the link $P p$; by which arrangement it is evident that the rectilinear motion of the two piston-rods will be rendered compatible with the alternate circular motions of the points P' and P on the beam.

Among the many mechanical inventions produced by the fertile genius of Watt, there is none which has excited such universal, such unqualified, and such merited admiration, as that of the parallel motion. It is indeed impossible, even for an eye unaccustomed to view mechanical combinations, to behold the beam of a steam-engine moving the pistons, through the instrumentality of the parallel motion, without an instinctive feeling of pleasure at the unexpected fulfilment of an end by means having so little apparent connexion with it. When this feeling was expressed to Watt himself, by those who first beheld the performance of this exquisite mechanism, he exclaimed, with his usual vivacity, that he himself, when he first beheld his own contrivance in action, was affected by the same sense of pleasure and surprise at its regularity and precision. He said that he received from it the same species of enjoyment that usually accompanies the first view of the successful invention of another person.

“ Among the parts composing the steam-engine, you have doubtless,” says M. Arago, “ observed a certain articulated parallelogram. At each ascent and descent of the piston, its angles open and close with the sweetness—I had almost said with the grace—which charms you in the gestures of a consummate actor. Follow with your eye alternately the progress of its successive changes, and you will find them subject to the most curious geometrical conditions. You will see, that of the four angles of the jointed parallelograms, three describe circular arches, but the fourth, which holds the piston-rod, is moved nearly in a straight line. The immense utility of this result strikes mechanicians with even less force than the simplicity of the means by which Watt has attained it.”

The parallel motion, of which there are several other varieties—depending, however, generally upon the same principle—formed part of a patent which Mr. Watt obtained in the year 1784, another part of which patent was for a locomotive-engine, by which a carriage was to be propelled on a road. In a letter to Mr. Smeaton, dated 22d October, in the same year, Watt says :—

“ I have lately contrived several methods of getting entirely rid of all the chains and circular arches about the great levers of steam-engines, and nevertheless making the piston-rods ascend and descend perpendicularly, without any sliding motions or right-lined guides, merely by combinations of motions about centres ; and with this further advantage, that they answer equally well to push upward as to pull downward, so that this method is applicable to our double engines, which act both in the ascent and descent of their pistons.

“ A rotative-engine of this species with the new motion which is now at work in our manufactory (but must be sent away very soon) answers admirably. It has cost much brain-work to contrive proper working-gear for these double engines, but I have at last done it tolerably well, by means of the circular valves, placed in an inverted position, so as to be opened by the force of

the steam ; and they are kept shut by the working-gear. We have erected an engine at Messrs. Goodwyne and Co.'s brewery, East Smithfield, London."

By the contrivance which has been explained above, the force of the piston in ascending and descending would be conveyed to the working end of the beam ; and the next problem which Watt had to solve was, to produce by the force exerted by the working end of the beam in ascending and descending a continuous motion of rotation. In the first instance he proposed to accomplish this by a crank placed upon the axle to which rotation was to be imparted, and driven by a rod connecting it with the working end of the beam. Let K, fig. 19,

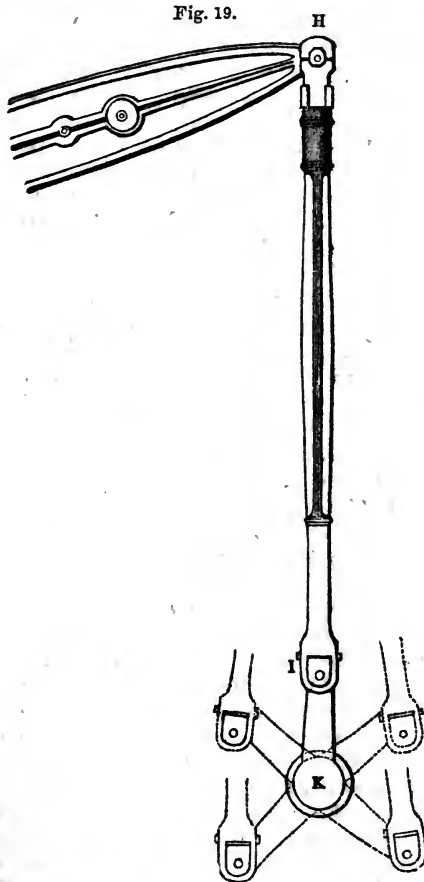

be the centre, to which motion is to be imparted by the working end H of the beam. On the axle K suppose a short lever K I to be fixed, so that when K I is turned round the centre K, the axle must turn with it. Let an iron rod, the weight of which shall balance the piston and piston-rod at the other end of the beam, be connected by joints with the working end H of the beam, and the extremity I of the lever K I. As the end H of the beam is moved upward and downward, the lever K I will be turned round the centre K, taking successively the positions represented by faint lines in the figure ; and thus a motion of continued rotation will be imparted to the axle K.

This simple and effectual expedient of producing a continued rotatory motion by a crank was abandoned by Watt, as already explained, by reason of a patent having been obtained upon information of his experiments surreptitiously procured. To avoid litigation, he therefore substituted for the crank the sun-and-planet wheel already described; but at the expiration of the patent, which restricted the use of the crank, the sun-and-planet wheel was discontinued in Watt's engine, and the crank restored.

Whether the crank or the sun-and-planet wheel be used, there is still a difficulty in the maintenance of a regular motion of rotation. In the various positions which the crank and connecting-rod assume throughout a complete revolution, there are two in which the moving power loses all influence in impelling the crank. These positions are those which the crank assumes when the piston is at the top and bottom of the cylinder, and is just about to change the direction of its motion. When the piston is at the bottom of the cylinder, the pivot I, fig. 19, by which the connecting-rod H I is attached to the end of the crank, is immediately over the axle K of the crank, and under the pivot H, which joins the upper end of the connecting-rod with the beam. In fact, in this position the connecting-rod and crank are in the same straight line, extending from the end of the beam to the axle of the crank. The steam, on entering the cylinder below the piston, and pressing it upward, would produce a corresponding downward force on the connecting rod at H, which would be continued along the connecting-rod and crank to the axle K. It is evident that such a force could have no tendency to turn the crank round, but would expend its whole energy in pressing the axle K downward.

The other position in which the power loses its effect upon the crank is when the piston is at the top of the cylinder. In this case, the working end of the beam will be at the lowest point of its play, and the crank-pin I will be immediately below the axle K; so that K will be placed immediately between H and I. When the steam presses on the top of the piston, it will expend its force in drawing the end H of the connecting-rod upward, by which the crank-pin I will likewise be drawn upward. It is evident that this force can have no effect in turning the crank round, but will expend its whole energy in producing an upward strain on the axle K.

If the crank were absolutely at rest in either of the positions above described, it is apparent that the engine could not be put in motion by the steam; but if the engine has been previously in motion, then the mass of matter forming the crank, and the axle on which the crank is formed, having already had a motion of rotation, will have a tendency to preserve the momentum it has received, and this tendency will be sufficient to throw the crank K I out of either of those critical positions which have been described. Having once escaped these dead points, then the connecting-rod forming an angle, however obtuse or acute, with the crank, the pressure or pull upon the former will have a tendency to produce rotation in the latter. As the crank revolves, however, the influence of the connecting-rod upon it will vary according to the angle formed by the connecting-rod and crank. When that angle is a right angle, then the effect of the connecting-rod on the crank is greatest, since the force upon it has the advantage of the whole leverage of the crank; but according as the angle formed by the crank and connecting-rod becomes more or less acute or obtuse in the successive attitudes which they assume in the revolution of the crank, the influence of the connecting-rod over the crank varies, changing from nothing at the two dead points already described, to the full effect produced in the two positions where they are at right angles. In consequence of this varying leverage, by which the force with which the connecting-rod is driven by the steam is transmitted to the axle on which the crank

revolves, a corresponding variation of speed would necessarily be produced in the motion imparted to the crank. The speed at the dead points would be least, being due altogether to the momentum already imparted to the revolving mass of the crank and axle; and it would gradually increase and be greatest at the points where the effect of the crank on the connecting-rod is greatest. Although this change of speed would not affect the actual mechanical efficacy of the machine, and although the same quantity of steam would perform the same work at the varying velocity as it would do if the velocity were regulated, yet this variation of speed would be incompatible with the purposes to which it was now proposed that the steam-engine should be applied in manufactures. In these a regular uniform motion should be imparted to the main axle.

One of the expedients which Watt proposed for the attainment of this end was, by placing two cranks on the same axle, in different positions, to be worked by different cylinders, so that while one crank should be at its dead points, the other should be in the attitude most favorable for its action. This expedient has since, as we shall see, been carried into effect in steam-vessels; but one more simple and efficient presented itself in the use of a *fly-wheel*.

On the main axle driven by the crank Watt placed a large wheel of metal, called a *fly-wheel*. This wheel being well constructed, and nicely balanced on its axle, was subject to very little resistance from friction; any moving force which it would receive it would therefore retain, and would be ready to impart such moving force to the main axle whenever that axle ceased to be driven by the power. When the crank, therefore, is in those positions in which the action of the power upon it is most efficient, a portion of the energy of the power is expended in increasing the velocity of the mass of matter composing the fly-wheel. As the crank approaches the dead points, the effect of the moving power upon the axle and upon the crank is generally enfeebled, and at these points vanishes altogether. The momentum which has been imparted to the fly-wheel then comes into play, and carries forward the axle and crank out of the dead points with a velocity very little less than that which it had when the crank was in the most favorable position for receiving the action of the moving power.

By this expedient, the motion of revolution received by the axle from the steam-piston is subject to no other variation than just the amount of change of momentum in the great mass of the fly-wheel, which is sufficient to extricate the crank twice in every revolution from the mechanical dilemma to which its peculiar form exposes it; and this change of velocity may be reduced to as small an amount as can be requisite by giving the necessary weight and magnitude to the fly-wheel.

By such arrangements the motion imparted to the main axle K would be uniform, provided that the moving power of the engine be always proportionate to the load which it drives. But in the general application of the steam-engine to manufactures it was evident that the amount of the resistance to which any given machine would be subject must be liable to variation. If, for example, the engine drive a cotton-mill, it will have to impart motion to all the spinning frames in that mill. The operation of one or more of these may from time to time be suspended, and the moving power would be relieved from a corresponding amount of resistance. If, under such circumstances, the energy of the moving power remained the same, the velocity with which the machines would be driven would be subject to variation, being increased whenever the operation of any portion of the machines usually driven by it is suspended; and, on the other hand, diminished when any increased number of machines are brought into operation. In fine, the speed would vary nearly in the inverse proportion of the load driven, increasing as the load is diminished, and *vice versa*.

On the other hand, supposing that no change took place in the amount of the load driven by the engine, and that the same number of machines of whatever kind would have to be continually driven, the motion imparted to the main axle would still be subject to variation by the changes inevitable to the moving power. The piston of the engine being subject to an unvaried resistance, a uniform motion could only be imparted to it, by maintaining a corresponding uniformity in the impelling power. This would require a uniform supply of steam from the boiler, which would further imply a uniform rate of evaporation in the boiler, unless means were provided in the admission of steam from the boiler to the cylinder to prevent any excess of steam which might be produced in the boiler from reaching the cylinder.

This end was attained by a contrivance afterward called the *throttle-valve*. An axis A B figs. 20, 21, was placed across the steam-pipe in a ring of cast-

Fig. 20.

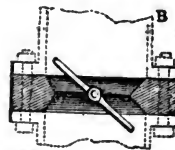
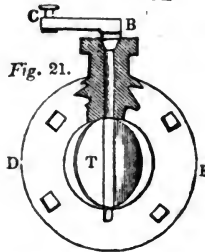

Fig. 21.



iron D E, of proper thickness. On this axis was fastened a thin circular plate T, of nearly the same diameter as the steam-pipe. On the outer end B of this axle was placed a short lever or handle B C, by which it could be turned. When the circular plate T was turned into such a position as to be at right angles to the length of the tube, it stopped the passage within the tube altogether, so that no steam could pass from the boiler to the engine. On the other hand, when the handle was turned through a fourth of a revolution from this position, then the circular plate T had its plane in the direction of the length of the tube, so that its edge would be presented toward the current of steam flowing from the boiler to the cylinder. In that position the passage within the tube would be necessarily unobstructed by the throttle-valve. In intermediate positions of the valve, as that represented in figs. 20, 21, the passage might be left more or less opened, so that steam from the boiler might be admitted to the cylinder in any regulated quantity according to the position given to the lever B C.

A view of the throttle-valve taken by a section across the steam-pipe is exhibited in fig. 21, and a section of it through the axis of the steam-pipe is represented in fig. 20. The form of the valve is such, that, if accurately constructed, the steam in passing from the boiler would have no effect by its pressure to alter any position which might be given to the valve; and any slight inaccuracy of form which might give a tendency to the steam to alter the position would be easily counteracted by the friction of the valve upon its axle. The latter might be regulated at pleasure.

By this expedient, however the evaporation of water in the boiler might vary within practical limits, the supply of steam to the cylinder would be rendered regular and uniform. If the boiler became too active, and produced more steam than was necessary to move the engine with its load at the requisite speed, then the throttle-valve was shifted so as to contract the passage and limit the supply of steam. If, on the other hand, the process of evaporation in the boiler was relaxed, then the throttle-valve was placed with its edge more directed toward the steam. Independently of the boiler, if the load on the engine was lightened, then the same supply of steam to the cylinder would unduly accelerate the motion. In this case, likewise, the partial closing of the throttle-valve would limit the supply of steam and regulate the motion; and if, on the other hand, the increase of load upon the engine rendered necessary an increased supply of steam, then the opening of the throttle-valve would accomplish the purpose. By these means, therefore, a uniform motion might be maintained, provided the vigilance of the engine-man was sufficient for the due management of the lever B C, and provided that the furnace under the boiler was kept in sufficient activity to supply the greatest amount of steam which would be necessary for the maintenance of a uniform motion with the throttle-valve fully opened.

Watt, however, soon perceived that the proper manipulation of the lever B C would be impracticable with any degree of vigilance and skill which could be obtained from the persons employed to attend the engine. He, therefore, adapted to this purpose a beautiful application of a piece of mechanism, which had been previously used in the regulation of mill-work, and which has since been well known by the name of the *governor*, and has always been deservedly a subject of much admiration.

The governor is an apparatus by which the axle of the fly-wheel is made to regulate the throttle-valve, so that the moment that the axle begins to increase its velocity, it shifts the position of the throttle-valve, so as to limit the supply of steam from the boiler, and thereby to check the increase of speed. And on the other hand, whenever the velocity of the axle is diminished, the lever B C is moved in the contrary direction, so as to open more fully the passage for the steam, and accelerate the motion of the engine.

A small grooved wheel A B fig. 22, is attached to a vertical spindle supported in pivots or sockets C and D, in which it is capable of revolving. An endless cord works in the groove A B, and is carried over proper pulleys to the axle of the fly-wheel, where it likewise works in a groove. When this cord is properly tightened the motion of the fly-wheel will give motion to the wheel A B, so that the velocity of the one will be subject to all the changes incidental to the velocity of the other. By this means the speed of the grooved wheel A B may be considered as representing the speed of the fly-wheel, and of the machinery which the axle of the fly-wheel drives.

It is evident that the same end might be attained by substituting for the grooved wheel A B a toothed wheel, which might be connected by other toothed wheels, and proper shafts, and axles with the axle of the fly-wheel.

A ring or collar E is placed on the upright spindle, so as to be capable of moving freely upward and downward. To this ring are attached by pivots two short levers, E F, the pivots or joints at E allowing these levers to play upon them. At F these levers are joined by pivots to other levers F G, which cross each other at H, where an axle or pin passes through them, and attaches them to the upright spindle C D. These intersecting levers are capable, however, of playing on this axle or pin H. To the ends G of these levers are attached two heavy balls of metal I. The levers F G pass through slits in a metallic arch attached to the upright spindle, so as to be capable of

Fig. 22.

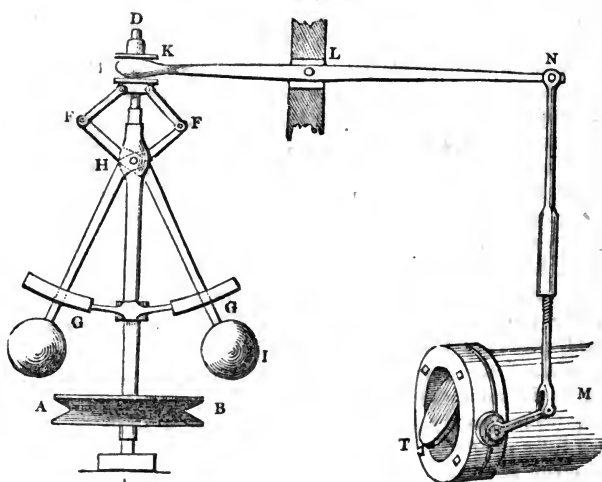

revolving upon it. If the balls I are drawn outward from the vertical axis, it is evident that the ends F of the levers will be drawn down, and therefore the pivots E likewise drawn down. In fact, the angles E F H will become more acute, and the angle F E F more obtuse. By these means the sliding ring E will be drawn down. To this sliding ring E, and immediately above it, is attached a grooved collar, which slides on the vertical spindle upward and downward with the ring E. In the grooved collar are inserted the prongs of a fork K, formed at the end of the lever K L, the fulcrum or pivot of the lever being at L. By this arrangement, when the divergence of the balls I causes the collar E to be drawn down, the fork K, whose prongs are inserted in the groove of that collar, is likewise drawn down; and, on the other hand, when, by reason of the balls I falling toward the vertical spindle, the collar E is raised, the fork K is likewise raised.

The ascent and descent of the fork K necessarily produce a contrary motion in the other end N of the lever. This end is connected by a rod, or system of rods, with the end M of the short lever which works the throttle-valve T. By such means the motion of the balls I, toward or from the vertical spindle, produces in the throttle-valve a corresponding motion; and they are so connected that the divergence of the balls I will cause the throttle-valve to close, while their descent toward the vertical spindle will cause it to open.

These arrangements being comprehended, let us suppose that, either by reason of a diminished load upon the engine or an increased activity of the boiler, the speed has a tendency to increase. This would impart increased velocity to the grooved wheel A B, which would cause the balls I to revolve with an accelerated speed. The centrifugal force which attends their motion would therefore give them a tendency to move from the axle, or to diverge. This would cause, by the means already explained, the throttle-valve T to be partially closed, by which the supply of steam from the boiler to the cylinder would be diminished, and the energy of the moving power, therefore, mitigated. The undue increase of speed would thereby be prevented.

If, on the other hand, either by an increase of the load, or a diminished activity in the boiler, the speed of the machine was lessened, a corresponding diminution of velocity would take place in the grooved wheel A B. This

would cause the balls I to revolve with less speed, and the centrifugal force produced by their circular motion would be diminished. This force being thus no longer able fully to counteract their gravity, they would fall toward the spindle, which would cause as, already explained, the throttle-valve to be more fully opened. This would produce a more ample supply of steam to the cylinder, by which the velocity of the machine would be restored to its proper amount.

The principle which renders the governor so perfect a regulator of the velocity of the machine is difficult to be explained without having recourse to the aid of the technical language of mathematical physics. As, however, this instrument is of such great practical importance, and has attracted such general admiration, it may be worth while here to attempt to render intelligible the mechanical principles which govern its operation. Let S fig. 23, be the

Fig. 23.

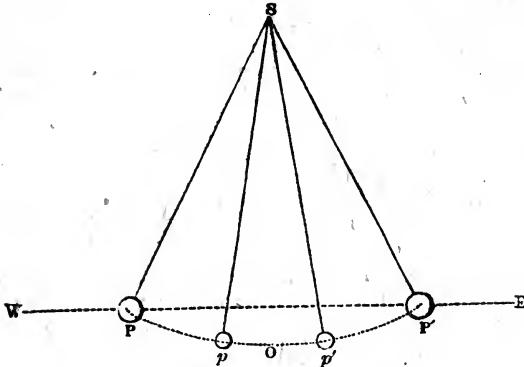

point of suspension of a common pendulum S P, and let P O P' be the arch of its vibration, so that the ball P shall swing or vibrate alternately to the east and to the west of the lowest point O, through the arches O P' and O P. It is a property of such an instrument that, provided the arch in which it vibrates be not considerable in magnitude, the time of its vibration will be the same whether the arch be long or short. Thus, for example, if the pendulum, instead of vibrating in the arch P P', vibrated in the arch p p', the time which it would take to perform its vibrations would be the same. If, however, the magnitude of the arch of vibration be increased, then a variation will take place in the time of vibration; but unless the arch of vibration be considerably increased, this variation will not be great.

Now let it be supposed that while the pendulum P P' continues to vibrate east and west through the arch P P', it shall receive such an impulse from north and south as would, if it were not in a state of previous vibration, cause it to vibrate between north and south, in an arch similar to the arch P P'. This second vibration between north and south would not prevent the continuance of the other vibration between east and west; but the ball P would be at the same time affected by both vibrations. While, in virtue of the vibration from east to west, the ball would swing from P to P', it would, in virtue of the other vibration, extend its motion toward the north to a distance from the line W E equal to half a vibration, and will return from that distance again to the position P'. While returning from P' to P, its second vibration will carry it toward the south to an equal distance on the southern side of W E, and it will return again to the position P. If the combination of these two motions or

vibrations be attentively considered, it will be perceived that the effect on the ball will be a circular motion, precisely similar to the circular motion of the balls of the governor already described.

Now the time of vibration of the pendulum $S P$ between east and west will not in any way be affected by the second vibration, which it is supposed to receive between north and south, and therefore the time the pendulum takes in moving from P to P' and back again from P' to P will be the same whether it shall have simultaneously or not the other vibration between north and south. Hence it follows that the time of revolution of the circular pendulum will be equal to the time of similar vibrations of the same pendulum, if, instead of having a circular motion, it were allowed to vibrate in the manner of a common pendulum.

If this point be understood, and if it also be remembered that the time of vibration of a common pendulum is necessarily the same whether the arch of vibration be small or great, it will be easily perceived that the revolving pendulum or governor will have nearly the same time of revolution whether it revolve in a large circle or a small one: in other words, whether the balls revolve at a greater or a less distance from the central spindle or axis. This, however, is to be understood only approximately. When the angle of divergence of the balls is as considerable as it usually is in governors, the time of revolution at different distances from the axis will therefore be subject to some variation, but to a very small one.

The centrifugal force (which is the name given in mechanics to that influence which makes a body revolving in a circle fly from the centre) depends conjointly on the velocity of revolution, and on the distance of the revolving body from the centre of the circle. If the velocity of revolution be the same, then the centrifugal force will increase in the same proportion as the distance of the revolving body from the centre. If, on the other hand, the distance of the revolving body from the centre remain the same, the centrifugal force will increase in the same proportion as the square of the time of vibration diminishes, or, in other words, it will increase in the same proportion as the square of the number of revolutions per minute. It follows from this, therefore, that the greater is the divergence of the balls of the governor, and the more rapidly they revolve, the greater will be their centrifugal force. Now this centrifugal force, if it were not counterbalanced, would give the balls a constant tendency to recede from the centre; but from the construction of the apparatus, the further they are removed from the centre the greater will be the effect of their gravitation in resisting the centrifugal force.

It is evident that the ball at P will have a greater tendency to fall by gravitation toward O than it would have at p , because the acclivity of the arch descending toward O at P is greater than its acclivity at p . The gravitation, therefore, or tendency of the ball to fall toward the central axis being greater at P than at p it will be able to resist a greater centrifugal force. This increased centrifugal force, which the ball would have revolving at the distance P above what it would have at the distance p , is produced partly by the greater distance of the ball from the central axis, and partly by the greater velocity of its motion. But it will be evident that the time of its revolution may nevertheless be the same, or nearly the same, at both distances. If it should appear that the actual velocity of its motion of revolution at P be greater than its velocity at p , in the same proportion as the circles in which they revolve, then it is evident that the time of revolution would be as much increased by the greater space which P will have to travel over, as it will have to be diminished by the greater speed with which that space is traversed. The time of revolution, therefore, may be the same, or nearly the same, in both cases.

If this explanation be comprehended, it will not be difficult to apply it to the actual case of the governor. If a sudden increase of the energy of the moving power, or a diminution of the load, should give the machine an increased velocity, then the increased speed of the balls of the governor will give them an increased centrifugal force, which for the moment will be greater than the tendency of their gravitation to make them fall toward the vertical axis. This centrifugal force, therefore, prevailing, the balls will recede from the axis; but as they recede, their gravitation toward the vertical axis will, as has been already explained, be increased, and will become equal to the centrifugal force produced by the increased velocity, provided that velocity do not exceed a certain limit. When the balls, by diverging, get such increased gravitation as to balance the centrifugal force, then they will continue to revolve at a fixed distance from the vertical axis. When this happens, the time of the revolution must be nearly the same as it was before their increased divergence; in other words, the proportion of the moving power to the load will be so restored by the action of the levers of the governor on the throttle-valve that the machine will move at its former velocity, or nearly so.

The principle on which the governor acts, as just explained, necessarily supposes temporary disarrangements of the speed. In fact, the governor, strictly speaking, does not maintain a uniform velocity, but restores it after it has been disturbed. When a sudden change of motion of the engine takes place, the governor, being immediately affected, will cause a corresponding alteration in the throttle-valve; and this will not merely correct the change of motion, but it will, as it were, overdo it, and will cause a derangement of speed of the opposite kind. Thus if the speed be suddenly increased to an undue amount, then the governor being affected will first close the throttle-valve too much, so as to reduce the speed below the proper limit. This second error will again affect the governor in the contrary way, and the speed will again be increased rather too much. In this way a succession of alterations of effect will ensue until the governor settles down into that position in which it will maintain the engine at the proper speed.

To prevent the inconvenience which would attend any excess of such variations, the governor is made to act with great delicacy on the throttle-valve, so that even a considerable change in the divergence of the balls shall not produce too much alteration in the opening of that valve: the steam in the boiler should have at least two pounds per square inch pressure more than is generally required in the cylinder. This excess is necessary to afford scope for that extent of variation of the power which it is the duty of the throttle-valve to regulate.

The governor is usually so adjusted as to make thirty-six revolutions per minute, when in uniform motion; but if the motion is increased to the rate of thirty-nine revolutions, the balls will fly to the utmost extent allowed them, being the limitation of the grooves in which their rods move; and if, on the other hand, the speed be diminished to thirty-four revolutions per minute, they will collapse to the lowest extent of their play. The duty of the governor, therefore, is to correct smaller casual derangements of the velocity; but if any permanent change to a considerable extent be made either in the load driven by the machine or in the moving power supplied to it from the boiler, then a permanent change is necessary to be made in the connexion between the governor and the throttle-valve, so as to render the governor capable of regulating those smaller changes to which the speed of the machine is liable.

Having thus explained the principal mechanical contrivances provided by Watt for the maintenance and regulation of the rotatory motion to be produced by his double-acting steam-engine, let us now consider the machine as a whole;

and investigate the process of its operation. A section of this engine is represented in fig. 24.

Fig. 24.

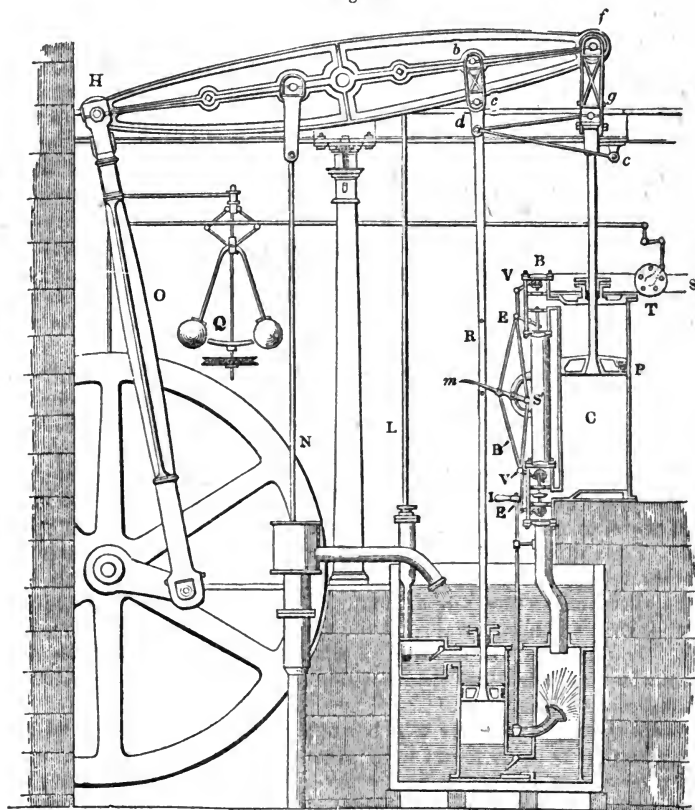

Steam is supplied from the boiler to the cylinder by the steam-pipe S. The throttle-valve T in that pipe, near the cylinder, is regulated by a system of levers connected with the governor. The piston P is accurately fitted in the steam-cylinder C by packing, as already described in the single-acting engine. This piston, as it moves, divides the cylinder into two compartments, between which there is no communication by which steam or any other elastic fluid can pass. The upper steam-box B is divided into three compartments by the two valves. Above the upper steam-valve V is a compartment communicating with the steam-pipe; below the upper exhausting-valve E is another compartment communicating with the eduction-pipe which leads to the condenser. By the valves V and E a communication may be opened or closed between the boiler on the one hand, or the condenser on the other, and the top of the cylinder. The continuation S' of the steam-pipe leads to the lower box B', which, like the upper, is divided into three compartments by two valves V' and E'. The upper compartment communicates with the steam-pipe, and thereby with the boiler; and the lower compartment communicates with the eduction-pipe, and thereby with the condenser. By means of the two valves V' and E', a communication may be opened or closed between the steam-pipe

on the one hand, or the exhausting-pipe on the other, and the lower part of the cylinder. The four valves V, E, V', and E', are connected by a system of levers with a handle or spanner *m*, which, being driven downward or upward, is capable of opening or closing the valves in pairs, in the manner already described. The condensers, the air-pump, and the hot-water pump, are in all respects similar to those already described in the single-acting engine, except that the condensing-jet is governed by a lever I, by which it is allowed to play continually in the condenser, and by which the quantity of water admitted through it is regulated. The cold-water pump N is worked by the engine as already described in the single-acting engine, and supplies the cistern in which the air-pump and condenser are submerged, so as to keep down its temperature to the proper limit. On the air-pump rod R are two pins properly placed, so as to strike the spanner *m*, upward and downward, at the proper times, when the piston approaches the termination of the stroke at the top or bottom of the cylinder. The pump L conducts the warm water drawn by the air-pump from the condenser to a proper reservoir for feeding the boiler. The vertical motion of the piston-rod in a straight line is rendered compatible with the circular motion of the end of the beam by the parallel motion already described. The point *b*, on the beam, moves upward and downward in a circular arch, of which the axis of the beam is the centre. In like manner, the point *d* of the rod *dc* moves upward and downward in a similar arch, of which the fixed pivot *c* is the centre. The joint or bar *db*, which joins these two pivots, will be moved so that its middle point *e* will ascend and descend nearly in a straight line, as has been already explained; opposite this point *e* is attached the piston-rod of the air-pump, which is accordingly guided upward and downward by this means. The jointed parallelogram *bdgf* is attached to the beam by pivots; and, as has been explained, the point *g* will be moved upward and downward in a straight line, through twice the space through which the point *e* is moved. To the point *g* the rod of the steam-piston is attached. Thus, the rods of the steam-piston and air-pump are moved by the same system of jointed bars, and moved through spaces which are in the proportion of two to one.

Although this system of jointed rods forming the parallel motion, appears in the figure to consist only of one parallelogram *bdgf*, and one rod *cd*, called the *radius rod*, it is, in fact, double, a similar parallelogram and radius rod being attached to corresponding points, and in the same manner on the other side of the beam; but from the view given in the cut, the one set of rods hides the other. The two systems of rods thus attached to opposite sides of the beam at several inches asunder, are connected by cross rods, the ends of which form the pivots or joints, and extend between the parallelograms. The ends of these rods are only visible in the figure. It is to the middle of one of these rods, the end of which is represented at *e*, that the air-pump piston-rod is attached; and it is to the middle of another, the end of which is represented at *g*, that the steam piston-rod is attached. These two piston-rods, therefore, are driven, not immediately by either of the parallelograms forming the parallel motion, but by the bars extending between them.

To the working end of the beam H is attached a rod of cast-iron O, called the *connecting-rod*, the lower end of which is attached to the crank by a pivot. The weight of the connecting-rod is so made, that it shall balance the weight of the piston-rods of the air-pump and cylinder on the other side of the beam; and the weight of the piston-rod of the cold-water pump N nearly balances the weight of the piston-rod of the hot-water pump L. Thus, so far as the weights of the machinery are concerned, the engine is in equilibrium, and the piston would rest in any position indifferently in the cylinder.

The axis of the fly-wheel on which the crank is formed is square in the

middle part, where the fly-wheel is attached to it, but has cylindrical necks at each end, which rest in sockets or bearings supported by the framing of the machine, in which sockets the axis revolves freely. On the axle of the crank is placed the fly-wheel, and connected with its axle is the governor Q, which regulates the throttle-valve T in the manner already described.

Let us now suppose the engine to be in full operation. The piston being at the top of the cylinder, the spanner *m* will be raised by the lower pin on the air-pump rod, and the upper steam-valve V, and the lower exhausting-valve E', will be opened, while the upper exhausting-valve E and the lower steam-valve V' are closed. Steam will, therefore, be admitted above the piston, and the steam which filled the cylinder below it will be drawn off to the condenser, where it will be converted into water. The piston will, therefore, be urged by the pressure of the steam above it to the bottom of the cylinder. As it approaches that limit, the spanner *m* will be struck downward by the upper pin on the air-pump rod, and the valves V and E' will be closed, and at the same time the lower steam-valve V' and the upper exhausting-valve E will be opened. Steam will, therefore, be admitted below the piston, while the steam above it will be drawn off into the condenser, and converted into water. The pressure of the steam, therefore, below the piston will urge it upward, and in the same manner the motion will be continued.

While this process is going on in the cylinder and the condenser, the water formed in the condenser will be gradually drawn off by the operation of the air-pump piston, in the same manner as explained in the single-acting engine; and at the same time the hot water thrown into the hot well by the air-pump piston will be carried off by the hot-water pump L.

Such are the chief circumstances attending the continuance of the operation of the double-acting engine. It is only necessary here to recall what has been already explained respecting the operation of the fly-wheel. The commencement of the motion of the piston from the top and bottom of the cylinder is produced, not by the pressure of the steam upon it upward or downward, which must, for the reasons already explained, be entirely inefficient; but by the momentum of the fly-wheel, which extricates the crank from those positions in which the moving power can not affect it.

The manner in which the motion of the crank affects the connecting-rod at the dead points produces an effect of great importance in the operation of the engine. When the crank-pin is approaching the lowest point of its play, and therefore the piston approaching the top of the cylinder, the motion of the crank-pin becomes nearly horizontal, and consequently its effect in drawing the connecting-rod and the working end of the beam downward and the piston upward, is extremely small. The consequence of this is, that as the piston approaches the top of the cylinder, its motion becomes very rapidly retarded; and as the motion of the crank-pin at its lowest point is actually horizontal, the piston is brought to a state of rest by this gradually-retarded motion at the top of the cylinder. In like manner, when the crank-pin moves from its dead point upward, its motion at first is very nearly horizontal, and consequently its effect in driving the working end of the beam upward, and the piston downward, is at first very small, but gradually accelerated. The effect of this upon the piston is, that it arrives at and departs from the top of the stroke with a very slow motion, being absolutely brought to rest at that point.

The same effect is produced when the piston arrives at the bottom of the cylinder. This retardation and suspension of the motion of the piston at the termination of the stroke affords time for the process of condensation to be effected, so that when the moving power of the steam upon the piston can come into action, the condensation shall be sufficiently complete. As the piston

approaches the top of the cylinder, and its motion becomes slow, the working-gear is made to open the lower exhausting-valve; the steam enclosed in the cylinder below the piston, and which has just driven the piston upward, presses with an elastic force of seventeen pounds per square inch on every part of the interior of the cylinder, while the uncondensed vapor in the condenser presses with a force of about two pounds per square inch. The steam, therefore, will have a tendency to rush from the cylinder to the condenser through the open exhausting-valve, with an excess of pressure amounting to fifteen pounds per square inch, while the piston pauses at the top of the cylinder. This process goes on, and when the piston has descended by the motion of the fly-wheel, a sufficient distance from the top of the cylinder to call the moving force of the steam into action, the exhaustion will be complete, and the pressure of the uncondensed vapor in the cylinder will become the same as in the condenser.

The pressure of steam in the cylinder, and of uncondensed vapor in the condenser, varies, within certain limits, in different engines, and therefore the amount here assigned them must be taken merely as an example.

The size of the valves by which the steam is allowed to pass from the cylinder to the condenser should be such as to cause the condensation to take place in a sufficiently short time, to be completed when the steam impelling the piston is called into action.

Watt, in the construction of his engines, made the exhaustion-valves with a diameter which was one fifth of the diameter of the cylinder, and therefore the actual magnitude of the aperture for the escape of the steam was one twenty-fifth of the magnitude of the cylinder; but the spindle of the valve diminished this so that the available space for the escape of steam did not exceed one twenty-seventh of the magnitude of the cylinder. This was found to produce a sufficiently rapid condensation.

It was usual to make the steam-valves of the same magnitude as the exhausting-valves, but the flow of steam through the former was resisted by the throttle-valve, while no obstruction was opposed to its passage through the latter.

The rapidity with which the cylinder must be exhausted by the condenser will, however, depend upon the velocity with which the piston is moved in it. The magnitude, therefore, of the exhausting-valves which would be sufficient for an engine which acts with a slow motion would be too small where a rapid motion is required.

In the single-acting steam-engine, where the moving force always acted downward on the piston, the pressure upon all the joints of the machinery by which the force of the piston was conveyed to the working parts, always took place in the same direction, and consequently whatever might be the mechanical connexion by which the several joints were formed, the pins by which they were connected, must always come to a bearing in their respective sockets, however loosely they may have been fitted. For the same reason, however, that the arch head and chain were abandoned as a means of connecting the steam-piston with the beam, and the parallel motion substituted, it was also necessary in the double-acting engine, where all joints whatever were driven alternately in opposite directions, to fit the connecting-pins with the greatest accuracy in their sockets, and to abandon all connexion of the parts by chains. If any sensible looseness was left in the joints, a violent jerk would be produced every time the motion of the piston was reversed. Any looseness either in the pivots or joints of the parallel motion of the working beam, the connecting rod, or crank, would, at every change of stroke, be so accumulated as to produce upon the machinery the effects of percussion, and would consequently

be attended with the danger of straining and breaking the moveable parts of the mechanism.

To secure, therefore, the necessary accuracy of the joints, Watt contrived that every joint in the engine should admit of the size of the socket being exactly adapted to the size of the pin, so as always to make a good fitting by closing the socket upon the pin, when any looseness would be produced by wear. With this view, all the joints were fitted with sockets made of brass or gun-metal, capable of adjustment. Each socket was composed of two pieces, accurately fitted into a cell or groove, in which one of the brasses can be moved toward the other by means of a wedge or screw. Each brass has in it a semi-cylindrical cavity, and the two cavities being opposed to each other, form a socket for the joint-pin. One of the two brasses can always be tightened round that pin, so as to enclose it tight between the two semi-cylindrical cavities, and to prevent any looseness taking place. The brasses, and other parts of such a joint, are represented in fig. 25. These joints still continue to be used in the engines as now constructed

Fig. 25.

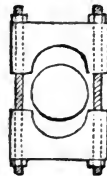

The motion of the working beam, and the pump-rods which it drives, and of the connecting rod, ought, if the whole were constructed with perfect precision, to take place in the same or parallel vertical planes; but this supposes a perfection of execution which could hardly have been expected in the early manufacture of such engines, whatever may have been attained by improvements which have been since made. In the details of construction, Watt saw that there would be a liability to lateral strain, owing to the planes of the different motions not being truly vertical and truly parallel, and that if a provision were not made for such lateral motion, the machinery would be subject to constant strain in its joints and rapid wear. He provided against this by constructing the main joints by which the great working lever was connected with the pistons and connecting rod, so as to form universal joints, giving freedom of motion laterally as well as vertically.

The great lever, or working beam, was so called from being originally made from a beam of oak. It is now, however, universally constructed of cast-iron. The connecting rod is also made of cast-iron, and attached to the beam and to the crank by axles or pivots.

The mechanism by which the four valves are opened and closed, is subject to considerable variation in different engines. They have been described above as being opened and closed simultaneously by a single lever. Sometimes, however, they are opened alternately in pairs by two distinct levers driven by two pins attached to the air-pump rod. One pin strikes the lever, which opens and closes the upper steam-valve, and lower exhausting-valve; the other strikes that which opens and closes the lower steam-valve and upper exhausting-valve.

Since the date of the earlier double-acting engines, constructed by Boulton and Watt, a great variety of mechanical expedients have been practised for working the valves, by which the steam is admitted to and withdrawn from the cylinder. We shall here describe a few of these methods:—

The method of working the valves by pins on the air-pump rod driving levers connected with the valves has been, in almost all modern double-acting machines, superseded by an apparatus called an *eccentric*, by which the motion of the axle of the fly-wheel is made to open and close the valves at the proper times.

An eccentric is a metallic circle attached to a revolving axle, so that the centre of the circle shall not coincide with the centre round which the axle revolves. Let us suppose that G, fig. 26, is a square revolving shaft. Let a

Fig. 26.

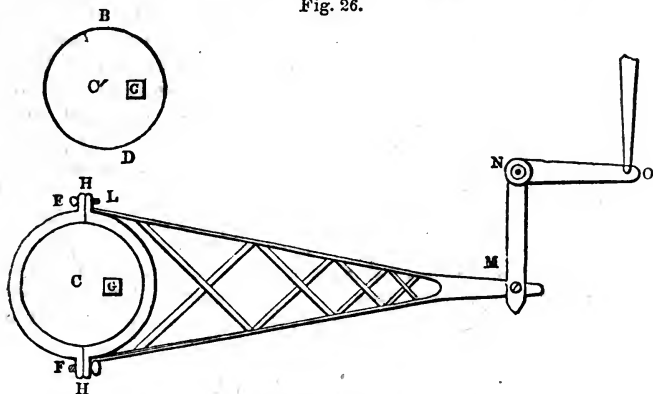

circular plate of metal B D, having its centre at C, have a square hole cut in it, corresponding to the shaft G, and let the shaft G pass through this square aperture, so that the circular plate B D shall be fastened upon the shaft, and capable of revolving with it as the shaft revolves. The centre C of the circular plate B D will be carried round the centre G of the revolving shaft, and will describe round it a circle, the radius of which will be the distance of the centre C of the circular plate from the centre of the shaft. Such circular plate so placed upon a shaft, and revolving with it, is an *eccentric*.

Let E F be a metallic ring, formed of two semicircles of metal screwed together at H, so as to be capable, by the adjustment of the screws, of having the circular aperture formed by the ring enlarged and diminished within certain small limits. Let this circular aperture be supposed to be equal to the magnitude of the eccentric B D. To the circular ring E F let an arm L M be attached. If the ring E F be placed around the eccentric B D, and that the screws H be so adjusted as to allow the eccentric B D to revolve within the ring E F, then while the eccentric revolves, the ring not partaking of its revolution, the arm L M will be alternately driven to the right and to the left, by the motion of the centre C of the eccentric as it revolves round the centre G of the axle. When the centre C of the eccentric is in the same horizontal line with the centre G, and to the left of it, then the position of L M will be that which is represented in fig. 26; but when, after half a revolution of the main axle, the centre C of the eccentric is thrown on the other side of the centre G, then the point M will be transferred to the right, to a distance equal to twice the distance C G. Thus as the eccentric B D revolves within the ring E F, that ring, together with the arm L M, will be alternately driven, right and left, through a space equal to twice the distance between the centre of the eccentric and the centre of the revolving shaft.

If we suppose a notch formed at the extremity of the arm L M, which is capable of embracing a lever N M, moveable on a pivot at N, the motion of the eccentric would give to such a lever an alternate motion from right to left,

and *vice versá*. If we suppose another lever N O connected with N M, and at right angles to it, forming what is called a bell-crank, then the alternate motion received by M, from right to left, would give a corresponding motion to the extremity O of the lever N O, upward and downward. If this last point O were attached to a vertical arm or shaft, it would impart to such arm or shaft an alternate motion upward and downward, the extent of which would be regulated by the length of the levers respectively.

By such a contrivance the revolution of the fly-wheel shaft is made to give an alternate vertical motion of any required extent to a vertical shaft placed near the cylinder, which may be so connected with the valves as to open and close them. Since the upward and downward motion of this vertical shaft is governed by the alternate motion of the centre C to the right and to the left of the centre G, it is evident that by the adjustment of the eccentric upon the fly-wheel shaft, the valves may be opened and closed at any required position of the fly-wheel and crank, and therefore at any required position of the piston in the cylinder.

Such is the contrivance by which the valves, whatever form may be given to them, are now almost universally worked in double-acting steam-engines.

Having described the general structure and operation of the steam-engine as improved by Watt, we shall now explain, in a more detailed manner, some parts of its machinery which have been variously constructed, and in which more or less improvements have been made.

OF THE COCKS AND VALVES.

In the steam-engine, as well as in every other machine in which fluids act, it is necessary to open or close, occasionally, the tubes or passages through which these fluids move. The instruments by which this is accomplished are called cocks or valves.

Cocks or valves may be classified by the manner in which they are opened: 1st, they may be opened by a motion similar to the lid of a box upon its hinges; 2d, they may be opened by being raised directly upward, in the same manner as the lid of a pot or kettle; 3d, they may be opened by a sliding motion, like that of the sash of a window or the lid of a box which slides in grooves; 4th, they may be opened by a motion of revolution, in the same manner as the cock of a beer-barrel is opened or closed. The term *valve* is more properly applied to the first and second of these classes; the third class are usually called *slides*, and the fourth *cocks*.

The single clack valve is the most simple example of the first class. It is usually constructed by attaching to a plate of metal larger than the aperture which the valve is intended to stop, a piece of leather, and to the under side of this leather another piece of metal smaller than the aperture. The leather extending on one side beyond the larger metallic plate, and being flexible, forms the hinge on which the valve plays. Such a valve is usually closed by its own weight, and opened by the pressure of the fluid which passes through it. It is also held closed more firmly by the pressure of the fluid whose return it is intended to obstruct. An example of this valve occurs in the steam-engine, in the passage between the condenser and the air-pump. The aperture which it stops is there a seat inclined at an angle whose inclination is such as to render the weight of the valve sufficient to close it. In cases where the valve is exposed to heat, as in the example just mentioned, where it is continually in contact with the hot water flowing from the condenser to the air-pump, the use of leather is inadmissible, and in that case the metallic surface of the valve is ground smooth to fit its seat.

The extent to which such a valve should be capable of opening, ought to

be such that the aperture produced by it shall be equal to the aperture which it stops. This will be effected if the angle through which it rises be about 30° .

The valve by which the air and water collected in the bottom of the air-pump are admitted to pass through the air-pump piston is a double clack, consisting of two semicircular plates, having the hinges on the diameters of these semicircles, as represented in fig. 27.

Fig. 27.



Of the valves which are opened by a motion perpendicular to their seat, the most simple is a flat metallic plate, made larger than the orifice which it is intended to stop, and ground so as to rest in steam-tight contact with the surface surrounding the aperture. Such a valve is usually guided in its perpendicular motion by a spindle passing through its centre, and sliding in holes made in cross bars extending above and below the seat of the valve.

The conical steam-valves, which have been already described, usually called spindle-valves, are the most common of this class. The best angle to be given to the conical seat is found in practice to be 45° . With a less inclination the valve has a tendency to be fastened in its seat, and a greater inclination would cause the top of the valve to occupy unnecessary space in the valve-box. The area, or transverse section of the valve-box, should be rather more than double the magnitude of the upper surface of the valve, in order to allow a sufficiently free passage for the steam, and the play of the valve should be such as to allow it to rise from its seat to a height not less than one fourth of the diameter of its upper surface.

The valves coming under this class are sometimes formed as spheres or hemispheres resting in a conical seat, and in such cases they are generally closed by their own weight, and opened by the pressure of the fluid which passes through them.

One of the advantages attending the use of slides, compared with the other form of valves, is the simplicity with which the same slide may be made to govern several passages, so that a single motion with a slide may perform the office of two or more motions imparted to independent valves.

In most modern engines the passage of the steam to and from the cylinder is governed by slides of various forms, some of which we shall now explain.

In figs. 28 and 29, is represented a slide-valve contrived by Mr. Murray of Leeds. A B is a steam-tight case attached to the side of the cylinder; E F is a rod, which receives an alternate motion, upward and downward, from the eccentric, or from whatever other part of the engine is intended to move the slide. This rod, passing through a stuffing-box, moves the slide G upward and downward. S is the mouth of the steam-pipe coming from the boiler; T is the mouth of a tube or pipe leading to the condenser; H is a passage leading to the top, and I to the bottom, of the cylinder. In the position of the slide represented in fig. 28, the steam coming from the boiler through S passes through the space H to the top of the cylinder, while the steam from the bottom of the cylinder passes through the space I into the tube T, and goes to the condenser. When the rod E F is raised to the position represented in fig. 29, then the passage H is thrown into communication with the tube T, while the

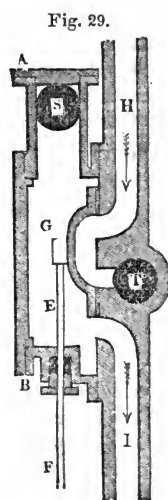
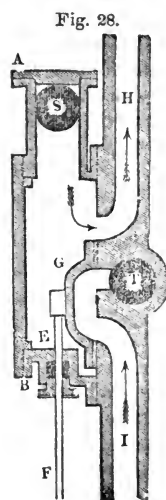

passage I is made to communicate with the tube S. Steam, therefore, passes from the boiler through I below the piston, while the steam which was above the piston, passing through H into T, goes to the condenser. Thus the single slide G performs the office of the four valves described in page 448.

The slide G has always steam of a full pressure behind it, while the steam in front of it escaping to the condenser, exerts but little pressure upon it. It is therefore always forcibly pressed against the surfaces in contact with which it moves, and is thereby maintained steam-tight. Indeed this pressure would rapidly wear the rubbing surfaces, unless they were made sufficiently extensive, and hardened so as to resist the effects of the friction. Where fresh water is used, as in land boilers, the slide may be made of hardened steel; and in the case of marine boilers, it may be constructed of gun-metal. In this and all other contrivances in which the apertures by which the steam is admitted to and withdrawn from the piston are removed to any considerable distance from the top and bottom of the cylinder, there is a waste of steam, for the steam consumed at each stroke of the piston is not only that which would fill the capacity of the cylinder, but also the steam which fills the passage between the slide G and the top or bottom of the cylinder. Any arrangement which would throw the passages H and I on the other side of the slide G, that is, between S and G, instead of being, as they are, between G and the top and bottom of the cylinder, would remove this defect. This is accomplished by a slide, which is usually called the D valve, because, being semi-cylindrical in its form, and hollow, its cross section resembles the letter D. This slide, which is that which at present is in the most general use, is represented in figs. 30, 31; E is the rod by which the slide is moved, passing through a stuffing-box F; G G is the slide represented by a vertical section, *a a* being a passage in it extending from the top to the bottom; S is the mouth of the great steam-pipe coming from the boiler; P is the pipe leading to the condenser; T H is a hollow space formed in the slide always in communication with the steam-pipe S, and consequently always filled with steam from the boiler. A transverse section of the slide and cylinder is represented in fig. 32, where *a* represents the top of the passage marked *a* in fig. 30. In the position of the slide represented in fig. 30, the steam filling the space T H has access to the top of the cylinder, but is excluded from the bottom. The steam which

Fig. 30.

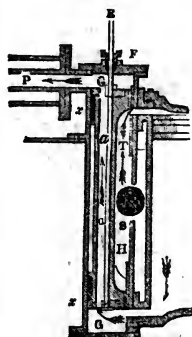

Fig. 31.

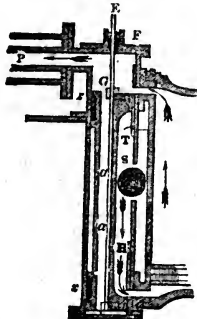

Fig. 32.



was below the piston, passing up the passage *a*, escapes through the tube *P* to the condenser. When the piston has descended, the rod *E* moves the slide downward, so as to give it the position represented in fig. 31. The steam in *T H* has now access to the bottom of the cylinder, while the steam above the piston passing through *P* escapes to the condenser. In this way the operation of the piston is continued and the steam consumed at each stroke only exceeds the capacity of the cylinder by what is necessary to fill the passages between the slide and the cylinder.

In a slide constructed in this manner, the steam filling the space *T H* has a tendency to press the slide back, so as to break the contact of the rubbing surfaces, and thereby to cause the steam to leak from the space *T H* to the back of the slide. This is counteracted by the packing *x*, at the back of the slide.

In engines of very long stroke, the extent of the rubbing surfaces of slides of this kind renders it difficult to keep them in steam-tight contact and to insure their uniform wear. In such cases, therefore, separate slides, upon the same principle, are provided at the top and bottom of the cylinder, moved, however, by a single rod of communication.

In slides, as we have here described them, the same motion which admits steam to either end of the cylinder, withdraws it from the other end. Such an arrangement is only compatible with the operation of a cylinder which works without expansion; for in such a cylinder the full flow of steam to the piston is only interrupted for a moment during the change of position of the slide. But if the steam act expansively, it would be necessary to move the slide, so as to stop its flow to one end of the cylinder, without at the same time obstructing the escape of steam from the other end to the condenser. It would therefore be necessary that the slide should close the passage leading to the cylinder at one end, without at the same time obstructing the communication between the passage from the cylinder to the condenser at the other end. On the arrival of the piston, however, at the bottom of the cylinder, it would be necessary immediately to put the lower passage to the cylinder in communication with the steam-pipe, and the upper passage in communication with the condenser. This would necessarily suppose two motions of the slide as well as some modifications in its length. Let the length of the slide be such that when the passage to the top of the cylinder is stopped, the lower part of the slide shall not reach the passage to the lower part of the cylinder; and let such a provision be made in the mechanism by which the rod *E* governing the slide is driven that it shall receive two motions during the descent of the piston, the first to be imparted to it at the moment the steam is to be cut off,

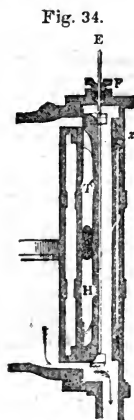
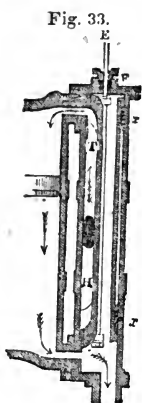

and the second just before the termination of the stroke. Let the position of the slide, at the commencement of the stroke, be represented in fig. 33, and let it be required that the steam shall be cut off at one half of the stroke. When the piston has made half the stroke, the rod governing the slide is moved downward, so as to throw the slide into the position represented in fig. 34. The passage between the steam-pipe and the cylinder is now stopped at both ends; but the passage from the bottom of the cylinder to the condenser remains open. During the remainder of the stroke, therefore, the steam in the cylinder works expansively. As the piston approaches the bottom of the cylinder, another motion is imparted to the rod governing the slide, by which the latter is thrown into the position represented in fig. 35. Steam now flows below the piston while the steam above it passes to the condenser. In a similar manner, by two motions successively imparted to the slide during the ascent of the piston, the steam may be cut off at half-stroke; and it is evident that by regulating the time at which these motions are given to the slide, the steam may be worked expansively, to any required extent.

It is easy to conceive various mechanical means by which, in the same engine, the point at which the steam is cut off may be regulated at pleasure.

In cases where the motion of the piston is very rapid, as in locomotive engines, it is desirable that the passages to and from the cylinder should be opened very suddenly. This is difficult to be accomplished with any form of slide consisting of a single aperture; but if, instead of admitting the steam to the cylinder by a single aperture, the same magnitude of opening were divided among several apertures, then a proportionally less extent of motion in the slide would clear the passage for the steam, and consequently greater suddenness of opening would be effected.

The great advantages in the economy of fuel resulting from the application of the expansive principle have, of late years, forced themselves on the attention of engineers, and considerable improvements have been made in its application, especially in the case of marine engines used for long voyages, in which the economy of fuel has become an object of the last importance. The mechanism by which expansive slides are moved, is made capable of adjustment, so that the part of the stroke at which the steam is cut off, can be altered at pleasure. The working power of the engine, therefore, instead of being controlled by the throttle-valve, is regulated by the greater or less extent to which the expansive principle is applied. Steam of the same pressure is ad-

mitted to the cylinder in all cases; but it is cut off at a greater or less portion of the stroke, according to the power which the engine is required to exert.

The last degree of perfection has been conferred on this principle by connecting the governor with the mechanism by which the slide is moved, so that the governor, instead of acting on the throttle-valve, is made to act upon the slide. By this means, when, by reason of any diminution of the resistance, the motion of the engine is accelerated, the balls of the governor diverging, shift the cam or lever which governs the slide, so that the steam is cut off after a shorter portion of the stroke, the expansive principle is brought into greater play, and the quantity of steam admitted to the cylinder at each stroke is diminished. If, on the other hand, the resistance to the machine be increased, so as to diminish the velocity of the engine, then the balls collapsing, the levers of the governor shift the cam which moves the slides, so as to increase the portion of the stroke made by the piston before the steam is cut off, and thereby to increase the amount of mechanical power developed in the cylinder at each stroke. The extent to which the expansive principle is capable of being applied, more especially in marine-engines, has been hitherto limited by the necessity of using steam of very high pressure, whenever the steam is cut off after the piston has performed only a small part of the stroke. A method, however, is now (March, 1840) under experimental trial, by Messrs. Maudsley and Field, by which the expansive principle may be applied to any required extent without raising the steam in the boiler above the usual pressure of from three to five pounds per square inch. This method consists in the use of a piston of great magnitude. The force urging the piston is thus obtained, not by an excessive pressure on a limited surface, but by a moderate pressure diffused over a large surface. The entire moving force acting on the piston before the steam is cut off, is considerably greater than the resistance; but during the remainder of the stroke this force is gradually enfeebled until the piston is brought to the extremity of its play.

Mr. Samuel Seaward, of the firm of Messrs. Seawards, engineers, has contrived an improved system of slides, for which he has obtained a patent. A section of Seaward's slides is represented in fig. 36. The steam-pipe pro-

Fig. 36.

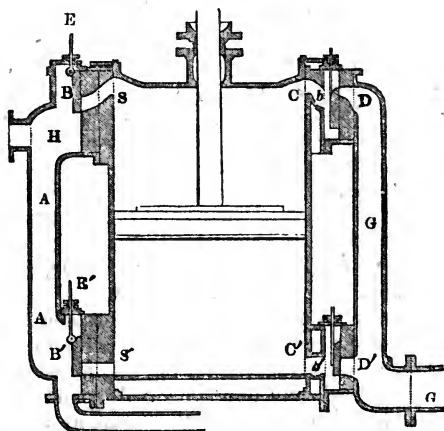

ceeding from the boiler to the cylinder is represented at A A, and it communicates with passages S and S' leading to the top and bottom of the cylinder.

These passages are formed in nozzles of iron or other hard metal cast upon the side of the cylinder. These nozzles present a smooth face outward, upon which the slides B B', also formed with smooth faces, play. The slides B B' are attached by knuckle-joints to rods E E', which move through stuffing-boxes, and the connexion of these rods with the slides is such that the slides have play so as to detach their surfaces easily from the smooth surfaces of the nozzles when not pressed against these surfaces. The steam in the steam-pipe A A will press against the backs of the slides B B', and keep their faces in steam-tight contact with the smooth surfaces of the nozzles. These slides may be opened or closed by proper mechanism at any point of the stroke. When steam is to be admitted to the top of the cylinder, the upper slide is raised and the passage S opened; and when it is to be admitted to the bottom of the cylinder, the lower slide is raised and the passage S' opened; and its communication to the top or bottom of the cylinder is stopped by the lowering of these slides respectively. On the other side of the cylinder are provided two passages C C' leading to a pipe G, which is continued to the condenser. On this pipe are cast nozzles of iron or other metal, presenting smooth faces toward the cylinder, and having passages D D' communicating between the top and bottom of the cylinder respectively and the pipe G G leading to the condenser. Two slides b b', having smooth faces turned from the cylinder, and pressing upon the faces of the nozzles D D', are governed by rods playing through stuffing-boxes, in the same manner as already described. The faces of these slides being turned from the cylinder, the steam in the cylinder having free communication with them, has a tendency to keep them by its pressure in steam-tight contact with the surfaces in which the apertures leading to the condenser are formed. These two slides may be opened or closed whenever it is necessary.

When the piston commences its descent, the upper steam-slide is raised, so as to open the passage S, and admit steam above the piston; and the lower exhausting-slide b' is also raised, so as to allow the steam below the piston to escape through G to the condenser, other two passages S' and C being closed by their respective slides. The slide which governs S is lowered at that part of the stroke at which the steam is intended to be cut off, the other slides remaining unchanged; and when the piston has reached the bottom of the cylinder, the lower steam-slide opens the passage S', and the upper exhausting-slide opens the passage C: and at the same time the lower exhausting-slide closes the passage C'. Steam being admitted below the piston through S', and at the same time the steam above it being drawn away to the condenser through the open passage C and the tube G, the piston ascends. When it has reached that point at which the steam is intended to be cut off, the slide which governs S' is lowered, the other slides remaining unaltered, and the upward stroke is completed in the same manner as the downward.

These four slides may be governed by a single lever, or they may be moved by separate means. From the small spaces between the several slides and the body of the cylinder, it will be evident that the waste of steam by this contrivance will be very small.

In the slide-valves commonly used, the packing of hemp at the back of the slide, by which the pressure necessary to keep the slide in steam-tight contact is obtained, requires constant attention from the engine-man while the engine is at work. Any neglect of this will produce a corresponding loss in the power of the engine; and accordingly it is found that in many cases where engines work inefficiently, the defect is owing either to ignorance or want of attention on the part of the engine-man in the packing of the slides. In Seaward's slides no hemp-packing is used, nor is any attention on the part of the engine-

man required after the slides are first adjusted. The slides receive the pressure necessary to keep them in steam-tight contact with the surfaces of the nozzles from the steam itself, which acts behind them.

The eduction and steam slides being independent of each other, they may be adjusted so that the engine shall work expansively in any required degree; and this may be accomplished either by working the slides by separate mechanism, or by a single eccentric.

One of the advantages claimed by the patentees for these slides is, that the engines are secured from the accidents which arise from the accumulation of water within the steam-cylinder. If such a circumstance should occur, the action of the piston will press the water against the faces of the steam-slides, and the play allowed to them by their connexion with the rods which move them permits their faces to be raised from the surfaces of the nozzles, so that the water collected in the cylinder shall be driven into the steam-pipe, and sent back thence to the boiler.

Of the cocks or valves which are opened and closed by the motion of an axis passing through their centre, the throttle-valve, whether worked by hand or by the governor, is an example. But the most common form for cocks is that of a cylindrical or slightly conical plug, fig. 37, inserted in an aperture of

Fig. 37.

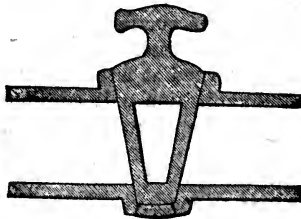

corresponding magnitude passing across the pipe or passage which the cock is intended to open or close. One or more holes are pierced transversely in the cock, and when the cock is turned so that these holes run in the direction of the tube, the passage through the tube is opened; but when the passage through the cock is placed at right angles to the tube, then the sides of the tube stop the ends of the passage in the cock, and the passage through the tube is obstructed. The simple cock is designed to open or close the passage through a single tube. When the cock is turned, as in fig. 38, so that the passage through the cock shall be at right angles to the length of the tube, then the passage through the tube is stopped; but when the cock is turned from that position through a quarter of a revolution, as in fig. 39, then the passage through

Fig. 38.

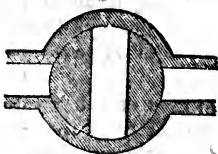
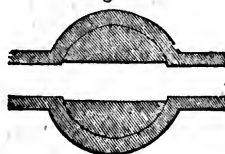

Fig. 39.



the cock takes the direction of the passage through the tube, and the cock is opened, and the passage through the tube unobstructed. In such a cock the passage may be more or less *throttled* by adjusting the position of the cock, so that a part of the opening in it shall be covered by the side of the tube.

It is sometimes required to put one tube or passage alternately in communication with two others. This is accomplished by a *two-way cock*. In this cock the passage is curved, opening usually at points on the surface of the cock, at right angles to each other.

When it is required to put four passages alternately in communication by pairs, a *four-way cock* is used. Such a cock has two curved passages (fig. 40),

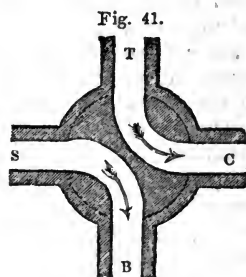
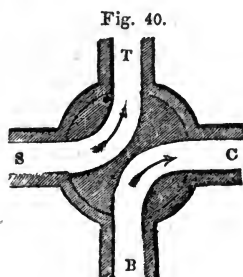

each similar to the curved passage in the two-way cock. Let S C B T be the four tubes which it is required to throw alternately into communication by pairs. When the cock is in the position fig. 40, the tube S communicates with T, and the tube C with B. By turning the cock through a quarter of a revolution, as in fig. 41, the tube S is made to communicate with B, and the tube C with T; and if the cock continue to be turned at intervals through a quarter of a revolution, these changes of communication will continue to be alternately made. It is evident that this may be accomplished by turning the cock continually in the same direction.

The four-way cock is sometimes used as a substitute for the valves or slides in a double-acting steam-engine to conduct the steam to and from the cylinder. If S represent a pipe conducting steam from the boiler, C that which leads to the condenser, T the tube which leads to the top of the cylinder, and B that which leads to the bottom, then when the cock is in the position fig. 40, steam would flow from the boiler to the top of the piston, while the steam below it would be drawn off to the condenser; and in the position fig. 41, steam would flow from the boiler to the bottom of the piston, while the steam above it would be drawn off to the condenser. Thus, by turning the cock through a quarter of a revolution toward the termination of each stroke, the operation of the machine would be continued.

One of the disadvantages which is inseparable from the use of a four-way cock for this purpose is the loss of the steam at each stroke, which fills the tubes between the cock and the ends of the cylinder. This disadvantage could only be avoided by the substitution of two two-way cocks instead of a four-way cock. A two-way cock at the top of the cylinder would open an alternate communication between the cylinder and steam-pipe, and the cylinder and condenser, while a similar office would be performed by another two-way cock at the other end.

The friction on cocks of this description is more than on other valves; but this is in some degree compensated by the great simplicity of the instrument. When the cock is truly ground into its seat, being slightly conical in its form, the pressure of the steam has a tendency to keep the surfaces in contact; but this pressure also increases the friction, and has a tendency to wear the seat of the cock into an elliptical shape. Consequently, such cocks require to be occasionally ground and refitted.

The four-way cock, as above described, admits the steam to one end of the piston at the same moment that it stops it at the other end. It would therefore be inapplicable where steam is worked expansively. A slight modification, however, analogous to that already described in the slides, will adapt it to expansive action. This will be accomplished by giving to one of the passages through the cock one aperture larger than the other, and working the cock so that this passage shall always be used to conduct steam to the cylinder; also by enlarging both apertures of the other passage, and using it always to conduct steam from the cylinder. The effect of such an arrangement will be readily understood.

Let the position of the cock at the commencement of the descending stroke be represented in fig. 42. Steam flows from S through T to the top of the

Fig. 42.

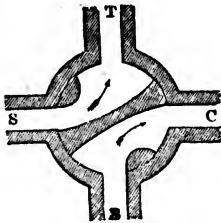
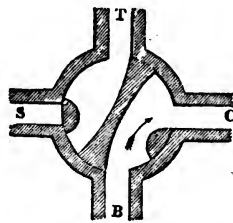

Fig. 43.



cylinder, while it escapes from B through C from the bottom of the cylinder. When the piston has arrived at that point at which the steam is to be cut off, let the cock be shifted to the position represented in fig. 43. The passage of steam from the boiler is now stopped, but the escape of steam from the bottom of the cylinder through C continues, and the cock is maintained in this position until the piston approaches the bottom of the cylinder, when it is further shifted to the position represented in fig. 44. Steam now flows from S through B

Fig. 44.

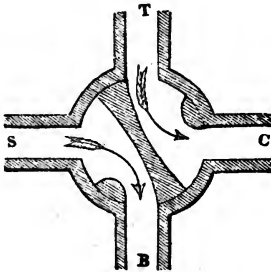
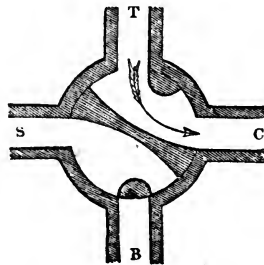

Fig. 45.



to the bottom of the cylinder, while the steam from the top of the cylinder escapes through C to the condenser. When the piston has arrived at that point where the steam is to be cut off, the cock is shifted to the position represented in fig. 45. The communication between the steam and the bottom of the piston is now stopped, while the communication between the top of the cylinder and the condenser is still open. During the next double stroke of the piston, the position of the cock is similarly changed, but in the contrary direction, and in the same way the motion is continued. Under these circumstances the

cock, instead of being moved constantly in the same direction, as in the case of the common four-way cock, will require to be moved alternately in opposite directions.

PISTONS.

The office of a piston being to divide a cylinder into two compartments by a moveable partition which shall obstruct the passage of any fluid from one compartment to the other, it is evident that the two conditions which such an instrument ought to fulfil are—*first*, that the contact of its sides with the surface of the cylinder shall be so close and tight throughout its entire play that no steam or other fluid can pass between them; *secondly*, that it shall be so free from friction, notwithstanding this necessary tightness, that it shall not absorb any injurious quantity of the moving power.

Since, however accurately the surfaces of the piston and cylinder may be constructed, there will always be in practice more or less imperfection of form, it is evident that the contact of the surface of the piston with the cylinder throughout the stroke can only be maintained by giving to the circumference of the piston sufficient elasticity to accommodate itself to such inequalities of form. The substance, whatever it may be, used for this purpose, and by which the piston is surrounded, is called *packing*.

In steam-pistons the material used for packing must be such as is capable of resisting the united effects of heat and moisture. Hence leather and other animal substances are inapplicable.

The packing used for steam-pistons is therefore of two kinds, *vegetable packing*, usually hemp, or *metallic packing*.

The bottom of the common hemp-packed piston is a circular plate just so much less in diameter than the cylinder as is sufficient to allow its free motion in ascending and descending. A little above its lowest point this plate begins gradually to diminish in thickness, until its diameter is reduced to from one to two inches less than that of the cylinder, leaving therefore around it a hollow space, as represented in fig. 46. The cover of the piston is a plate similarly

Fig. 46.

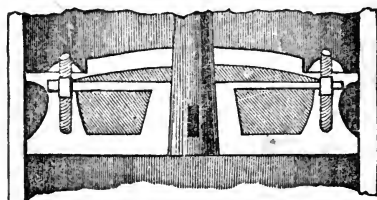

formed, being in like manner gradually reduced in thickness downward, so as to correspond with the lower plate. In the hollow space which thus surrounds the piston a packing of unspun hemp or soft rope, called *gasket*, is introduced by winding it round the piston so as to render it an even and compact mass. When the space is thus filled up, the top of the piston is attached to the bottom by screws. The curved form of the space within which the hempen packing is confined is such that, when the screws are tightened, that part of the packing which is nearest to the top and bottom of the piston is forced against the cylinder so as to produce upon the two parallel rings as much pressure as is necessary to render it steam-tight. When by use the packing is worn down so as to produce leakage, the cover of the cylinder must be removed, and the screws connecting the top and bottom of the piston tightened;

this will force out the packing and render the piston steam-tight. This packing is lubricated by melted tallow let down upon the piston from the funnel inserted in the top of the cylinder, furnished with a stop-cock to prevent the escape of steam. The lower end of the piston-rod is formed slightly conical, the thickest part of the cone being downward. It is passed up through the piston, and a nut or wedge between the top and bottom is inserted so as to secure the piston in its position upon the rod.

The process of removing the top of the cylinder for the purpose of tightening the screws in the piston is one of so laborious a nature, that the men intrusted with the superintendence of these machines are tempted to allow the engine to work, notwithstanding injurious leakage at the piston, rather than incur the labor of tightening the screws as often as it is necessary to do so.

To avoid this inconvenience, the following method of tightening the packing of the piston without removing the lid of the cylinder, was contrived by Woolf. The head of each of the screws was formed into a toothed pinion, and as these screws were placed at equal distances from the centre of the piston, these several pinions were driven by a large toothed wheel, revolving on the piston-rod as an axis. By such an arrangement it is evident that if any one of the screws be turned, a like motion will be imparted to all the others through the medium of the large central wheel. Woolf accordingly formed, on the head of one of the screws, a square end. When the piston was brought to the top of the cylinder, this square end entered an aperture made in the under side of the cover of the cylinder. This aperture was covered by a small circular piece screwed into the top of the cylinder, which was capable of being removed so as to render the square head of the screw accessible. When this was done, a proper key being applied to the square head of the screw, it was turned; and by being turned, all the other screws were in like manner moved. In this way, instead of having to remove the cover of the cylinder, which in large cylinders was attended with great labor and loss of time, the packing was tightened by merely unscrewing a piece in the top of the cylinder not much greater in magnitude than the head of one of the screws.

This method was further simplified by causing the great circular wheel already described to move upon the piston-rod, not as an axis, but as a screw, the thread being cut upon a part of the piston-rod which worked in a corresponding female screw cut upon the central plate. By such means, the screw whose head was let into the cover of the cylinder which turned, would cause this circular plate to be pressed downward by the force of the screw constructed on the piston-rod. This circular plate thus pressed downward, acted upon pins or plugs which pressed together the top and bottom of the cylinder in the same manner as they were pressed together by the screws connecting them as already described.

METALLIC PISTONS.

The notion of constructing a piston so as to move steam-tight in the cylinder without the use of packing of vegetable matter was first suggested by the Rev. Mr. Cartwright, a gentleman well known for other mechanical inventions. A patent was granted in 1797 for a new form of steam-engine, in which he proposed to use the vapor of alcohol to work the piston instead of the steam of water: and since the principle of the engine excluded the use of lubrication by oil or tallow, he substituted a piston formed of metallic rings pressed against the surface of the cylinder by springs, so as to be maintained in steam-tight contact with it, independently either of packing or lubrication. Although the engine for which this form of piston was intended never came into practical

use, yet it is so simple and elegant in its structure, and forms a link so interesting in the history of the steam-engine, that some explanation of it ought not to be omitted in this work.

The steam-pipe from the boiler is represented cut off at B, fig. 47; T is a

Fig. 47.

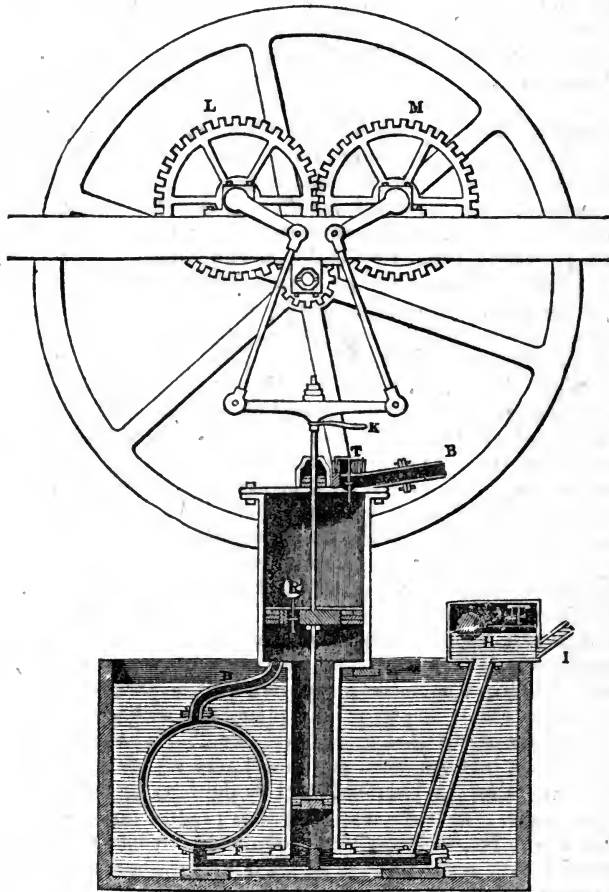

spindle-valve, for admitting steam above the piston, and R is a spindle-valve in the piston; D is a curved pipe forming a communication between the cylinder and the condenser, which is of very peculiar construction. Cartwright proposed effecting a condensation without a jet, by exposing the steam to contact with a very large quantity of cold surface. For this purpose, he formed his condenser by placing two cylinders nearly equal in size, one within the other, allowing the water of the cold cistern in which they were placed to flow through the inner cylinder, and to surround the outer one. Thus, the thin space between the two cylinders formed the condenser.

The air-pump is placed immediately under the cylinder, and the continuation of the piston-rod works its piston, which is solid and without a valve. F is the pipe from the condenser to the air-pump, through which the condensed

steam is drawn off through the valve G on the ascent of the piston, and on the descent is forced through a tube into a hot well H, for the purpose of feeding the boiler through the feed-pipe I. In the top of the hot well H is a valve which opens inward, and is kept closed by a ball floating on the surface of the liquid. The pressure of the condensed air above the surface of the liquid in H forces it through I into the boiler. When the air accumulates in too great a degree in H, the surface of the liquid is pressed so low that the ball falls and opens the valve, and allows it to escape. The air in H is that which is pumped from the condenser with the liquid, and from which it was disengaged.

Let us suppose the piston at the top of the cylinder: it strikes the tail of the valve T, and raises it, while the stem of the piston-valve R strikes the top of the cylinder, and is pressed into its seat. A free communication is at the same time open between the cylinder, below the piston and the condenser, through the tube D. The pressure of the steam thus admitted above the piston acting against the vacuum below it, will cause its descent. On arriving at the bottom of the cylinder, the tail of the piston-valve R will strike the bottom, and it will be lifted from its seat, so that a communication will be opened through it with the condenser. At the same moment, a projecting spring K, attached to the piston-rod, strikes the stem of the steam-valve T, and presses it into its seat. Thus, while the further admission of steam is cut off, the steam above the piston flows into the condenser, and the piston being relieved from all pressure, is drawn up by the momentum of the fly-wheel, which continues the motion it received from the descending force. On the arrival of the piston again at the top of the cylinder, the valve T is opened and R closed, and the piston descends as before, and so the process is continued.

The mechanism by which motion is communicated from the piston to the fly-wheel is peculiarly elegant. On the axis of the fly-wheel is a small wheel with teeth, which work in the teeth of another larger wheel L. This wheel is turned by a crank, which is worked by a cross-piece attached to the end of the piston-rod. Another equal-toothed wheel M is turned by a crank, which is worked by the other end of the cross-arm attached to the piston-rod.

One of the peculiarities of this engine is, that the liquid which is used for the production of steam in the boiler circulates through the machine without either diminution or admixture with any other fluid, so that the boiler never wants more feeding than what can be supplied from the hot well H. This circumstance forms an important feature in the machine, as it allows of ardent spirits being used in the boiler instead of water, which, since they boil at low heats, promised a saving of fuel. The inventor proposed that the engine should be used as a still, as well as a mechanical power, in which case the whole of the fuel would be saved.

That part of Cartwright's piston which in the common piston is occupied by the packing of gasket, already explained, was filled by a number of rings, one placed within and above another, and divided into three or four segments. Two rings of brass were made of the full size of the cylinder, and so ground as to fit the cylinder nearly steam-tight. These were cut into several segments A A A, fig. 48, and were placed one above the other, so as to fill the space between the top and bottom plates of the piston. The divisions of the segments of the one ring were made to fit between the divisions of the other. Within these, another series of rings, B B B, were placed, similarly constructed, so as to fit within the first series in the same manner as the first series were made to fit within the cylinder. The joints of the upper series of each set of rings are exhibited in the plan fig. 48;

Fig. 48.

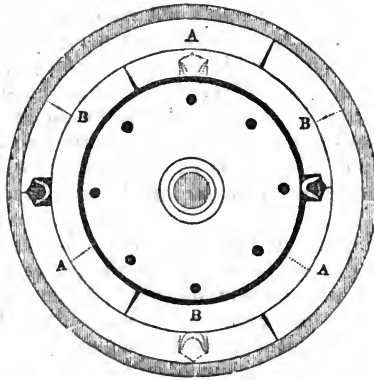

the places of the joints of the lower series are shown by dotted lines; the position of the rings of each series one above the other is shown in the section fig. 49. The joints of the inner series of rings are so placed as to lie

Fig. 49.

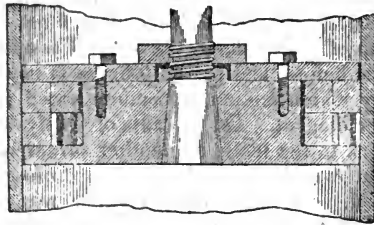

between those of the outer series, to prevent the escape of steam which would take place by one continued joint from top to bottom of the packing. The segments into which the rings are divided are pressed outward by steel springs in the form of the letter V, the springs which act upon the outer series of segments abutting upon the inner series, and those which act on the inner series abutting upon the solid centre of the piston: these springs are represented in fig. 48.

An improved form was given to the metallic piston by Barton. Barton's piston consists of a solid cylinder of cast-iron, represented at A in section in fig. 50, and in plan in fig. 51. In the centre of this is a conical hole, in-

Fig. 50.

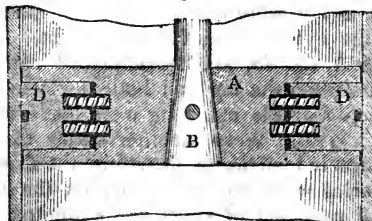
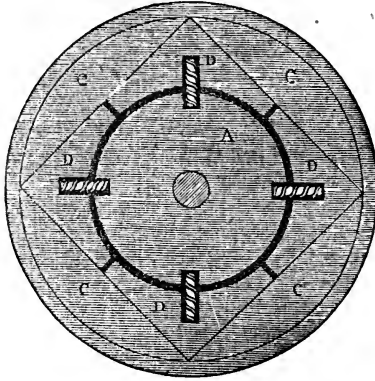

Fig. 51.



creasing in magnitude downward, to receive the piston-rod, in which the latter is secured by a cross-pin B. A deep groove, square in its section, is formed around the piston, so that while the top and bottom of the piston form circles equal in magnitude to the section of the cylinder, the intermediate part of the body of the piston forms a circle less than the former by the depth of the groove. Let a ring of brass, cast-iron, or cast-steel, be made to correspond in magnitude and form with this groove, and let it be divided as represented in fig. 51, into four segments C C C C, and four corresponding angular pieces D D D D. Let the groove which surrounds the piston be filled by the four segments with the four wedge-like angular pieces within them, and let the latter be urged against the former by eight spiral springs, as represented in fig. 50 and fig. 51. These springs will abut against the solid centre by the piston, and will urge the segments C against the cylinder. The spiral springs which urge the wedges are confined in their action by steel pins which pass through their centre, and by being confined in cylindrical cavities worked into the wedges and into corresponding parts of the solid centre of the piston, as the segments C wear, the springs urge the wedges outward, and the points of the latter protruding, are gradually worn down so as to fill up the spaces left between the segments, and thus to complete the outer surface of the piston.

Various other forms of metallic pistons have been proposed, but as they do not differ materially in principle from those we have just described, it will not be necessary here to describe them.

Faint, illegible text in the upper section of the page, possibly a list or a set of instructions.

Main body of faint, illegible text, appearing to be a detailed list or account with multiple columns.

Faint text at the bottom of the page, possibly a signature or a concluding note.

THE STEAM-ENGINE.

(FOURTH LECTURE.)

Analysis of Coal.—Process of Combustion.—Heat evolved in it.—Form and Structure of Boiler.—Wagon-Boiler.—Furnace—Method of Feeding it.—Combustion of Gas in Flues.—Williams's Patent for Method of Consuming unburned Gases.—Construction of Grate and Ash-Pit.—Magnitude of Heating Surface of Boiler.—Steam-Space and Water-Space in Boiler.—Position of Flues.—Method of Feeding Boiler.—Method of Indicating the Level of Water in Boiler.—Lever Gauges.—Self-Regulating Feeders.—Steam-Gauge.—Barometer-Gauge.—Watt's Invention of the Indicator.—Counter.—Safety-Valve.—Fusible Plugs.—Self-Regulating Damper.—Brunton's Self-Regulating Furnace.—Gross and Useful Effect of an Engine.—Power and Duty of Engines.—Horse-Power of Steam-Engines.—Table exhibiting the Mechanical Power of Water converted into Steam at various Pressures.—Evaporation Proportional to Horse-Power.—Sources of Loss of Power.—Absence of good Practical Rules for Power.—Common Rules followed by Engine-Makers.—Duty distinguished from Power.—Duty of Boilers.—Proportion of Stroke to Diameter of Cylinder.—Duty of Engines.—Cornish System of Inspection.—Table showing the Improvement of Cornish Engines.—Beneficial Effects of Cornish Inspection.—Successive Improvements on which the increased Duty of Engines depends, traced by John Taylor in his "Records of Mining."

THE BIBLE

BY

THE

AMERICAN BIBLE SOCIETY
NEW YORK
1850

THE STEAM-ENGINE.

(FOURTH LECTURE.)

THE machinery which has been explained, consisting of the cylinder with its passages and valves, the piston-rod, parallel motion, beam, connecting-rod and crank, together with the condenser, air-pump, and other appendages, having no source of moving power in themselves, must be regarded as mere instruments by which the mechanical effect developed by the furnace and the boiler is transmitted to the working point and so modified as to be adapted to the uses to which the machine is applied. The boiler is at once a magazine in which the moving power is stored in sufficient quantity to supply the demands of the engine and an apparatus in which that power is fabricated. The mechanical effect evolved in the conversion of water into steam by heat, is the process by which the power of the steam-engine is produced, and space is provided in the boiler, capacious enough to contain as much steam as is necessary for the engine, besides a sufficient quantity of water to continue that supply undiminished, notwithstanding the constant drafts made upon it by the cylinder: even the water itself, from the evaporation of which the mechanical power is produced, ought to be regarded as an instrument by which the effect of the heat of the combustible is rendered mechanically efficient, inasmuch as the same heat, applied not only to other liquids but even to solids, would likewise be productive of mechanical effects. The boiler and its furnace are therefore parts of the steam-engine, the construction and operation of which are entitled to especial attention.

COAL, the combustible almost universally used in steam-engines, is a substance, the principal constituents of which are *carbon* and *hydrogen*, occasionally mixed with sulphur in a small proportion, and earthy incombustible matter. In different sorts of coal the proportions of these constituents vary, but in coal of good quality about three quarters of the whole weight of the combustible is carbon.

When carbon is heated to a temperature of about 700° in an atmosphere of

pure oxygen it will combine chemically with that gas, and the product will be the gas called *carbonic acid*. The volume of carbonic acid produced by this combination, will be exactly equal to that of the oxygen combined with the carbon, and therefore the weight of a given volume of the gas will be increased by the weight of carbon which enters the combination. It is found that two parts by weight of oxygen combined with three of carbon, form carbonic acid. The weight of the carbonic acid, therefore, produced in the combustion, will be greater than the weight of the oxygen, bulk for bulk, in the proportion of five to two, the volume being the same and the gases being compared at the same temperatures and under equal pressures. In this combination heat is evolved in very large quantities. This effect arises from the heat previously latent in the carbon and oxygen being rendered sensible in the process of combustion. The carbonic acid proceeding from the combustion is by such means raised to a very high temperature, and the carbon during the process acquires a heat so intense as to become luminous; no flame, however, is produced.

Hydrogen, heated to a temperature of about $1,000^{\circ}$, in contact with oxygen will combine with the latter, and a great evolution of heat will attend the process; the gases will be rendered luminous, and flame will be produced. The product of this process will be water, which being exposed to the intense heat of combustion, will be immediately converted into steam. Hydrogen combines with eight times its own weight of oxygen, producing nine times its own weight of water.

Hydrogen gas is, however, not usually disengaged from coal in a simple form, but combined chemically with a certain portion of carbon, the combination being called carburetted hydrogen. Pure hydrogen burns with a very faintly luminous blue flame, but carburetted hydrogen gives that bright flame occasionally having an orange or reddish tinge, which is seen to issue from burning coals: this is the gas used for illumination, being expelled from the coal by the process of coking, and conducted to the various burners through proper pipes.

The sulphur, which in a very small proportion is contained in coals, is also combustible, and combines in the process of combustion with oxygen, forming sulphurous acid: it is also sometimes evolved in combination with hydrogen, forming sulphuretted hydrogen.

Atmospheric air consists of two gases, azote and oxygen, mixed together in the proportion of four to one; five cubic feet of atmospheric air consisting of four cubic feet of azote and one of oxygen. Any combustible will combine with the oxygen contained in atmospheric air, if raised to a temperature somewhat higher than that which is necessary to cause its combustion in an atmosphere of pure oxygen.

If coals, therefore, or other fuel exposed to atmospheric air, be raised to a sufficiently high temperature, their combustible constituents will combine with the oxygen of the atmospheric air, and all the phenomena of combustion will ensue. In order, however, that the combustion should be continued, and should be carried on with quickness and activity, it is necessary that the carbonic acid, and other products, should be removed from the combustible as they are produced, and fresh portions of atmospheric air brought into contact with it; otherwise the combustible would soon be surrounded by an atmosphere composed chiefly of carbonic acid to the exclusion of atmospheric air, and therefore of uncombined oxygen, and consequently the combustion would cease, and the fuel be extinguished. To maintain the combustion, therefore, a current of atmospheric air must be constantly carried through the fuel: the quantity and force of this current must depend on the quantity and quality of the fuel

to be consumed. It must be such that it shall supply sufficient oxygen to the fuel to maintain the combustion, and not more than sufficient, since any excess would be attended with the effect of absorbing the heat of combustion, without contributing to the maintenance of that effect.

Heat is communicated from body to body in two ways, by radiation and by contact.

Rays of heat issue from a heated body, and are dispersed through the surrounding space in a manner, and according to laws, similar to those which govern the radiation of light. The heat thus radiated meeting other bodies is imparted to them, and penetrates them with more or less facility according to their physical qualities:

A heated body also brought into contact with another body of lower temperature, communicates heat to that other body, and will continue to do so until the temperature of the two bodies in contact shall be equalized. Heat proceeds from fuel in a state of combustion in both these ways: the heated fuel radiates heat in all directions around it, and the heat thus radiated will be imparted to all parts of the furnace which are exposed to the fuel.

The gases, which are the products of the combustion, escape from the fuel at a very high temperature, and consequently, in acquiring that temperature they absorb a considerable quantity of the heat of combustion. But besides the gases actually formed in the process of combustion, the azote forming four fifths of the air carried through the fuel to support the combustion, absorbs heat from the combustible, and rises into the upper part of the furnace at a high temperature. These various gases, if conducted directly to the chimney, would

Fig. 52.

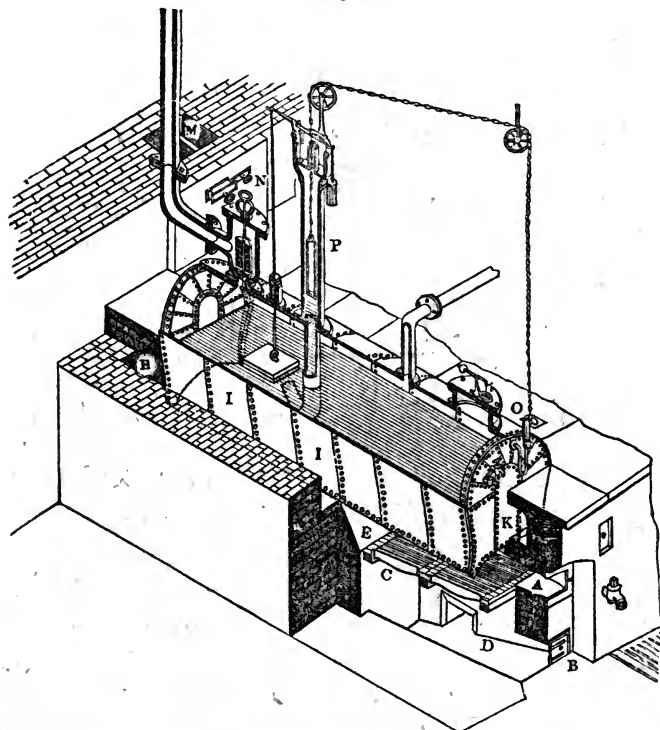

carry off with them a considerable quantity of the heat. Provision should therefore be made to keep them in contact with the boiler such a length of time as will enable them to impart such a portion of the heat which they have absorbed from the fuel, as will still leave them at a temperature sufficient, and not more than sufficient, to produce the necessary draught in the chimney.

The forms of boiler which have been proposed as the most convenient for the attainment of all these requisite purposes have been very various: If strength alone were considered, the spherical form would be the best; and the early boilers were very nearly hemispheres, placed on a slightly concave base. The form adopted by Watt, called the wagon-boiler, consists of a semi-cylindrical top, flat perpendicular sides, flat ends, and a slightly concave bottom. The steam intended to be used in boilers of this description did not exceed the pressure of the external atmosphere by more than from 3 to 5 lbs., per square inch; and the flat sides and ends, though unfavorable to strength, could be constructed sufficiently strong for this purpose. In a boiler of this sort, the air and smoke passing through the flues that are carried round it, are in contact at one side only with the boiler. The brickwork, or other materials forming the flue, must therefore be non-conductors of heat, that they may not absorb any considerable portion of heat from the air passing in contact with them. A boiler of this form is represented in fig. 52.

The grate and a part of the flues are rendered visible by the removal of a portion of the surrounding masonry in which the boiler is set. The interior of the boiler is also shown by cutting off one half of the semi-cylindrical roof. A longitudinal vertical section is shown in fig. 53, and a cross section in fig. 54:

Fig. 53

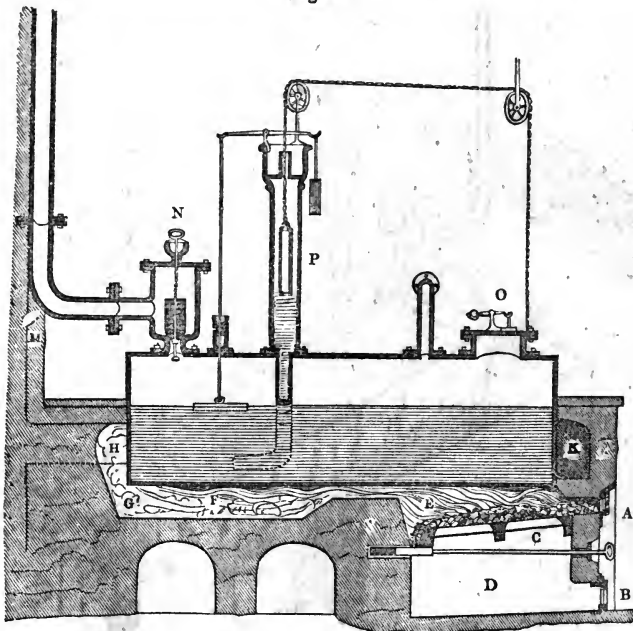

A horizontal section taken above the level of the grate, and below the level of the water in the boiler, showing the course of the flues, is given in fig. 55. The corresponding parts in all the figures are marked by the same letters.

Fig. 54.

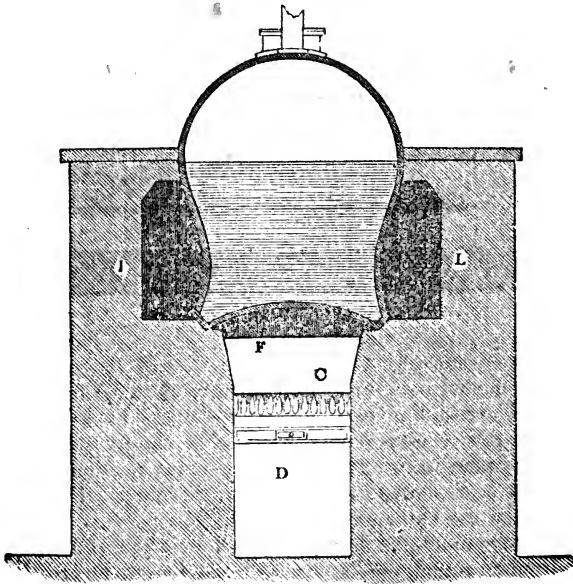

The door by which fuel is introduced upon the grate is represented at A, and the door leading to the ash-pit at B. The fire-bars at C slope downward from the front at an angle of about 25° , giving a tendency to the fuel to move from the front toward the back of the grate. The ash-pit D is constructed of such a magnitude, form, and depth, as to admit a current of atmospheric air to the grate-bars, sufficient to sustain the combustion. The form of the ash-pit is usually wide below, contracting toward the top.

The fuel when introduced at the fire-door A, should be laid on that part of the grate nearest to the fire-door, called the dead plates: there it is submitted to the process of coking, by which the gases and volatile matter which it contains are expelled, and being carried by a current of air, admitted through small apertures in the fire-door over the burning fuel in the hinder part of the grate, they are burnt. When the fuel in front of the grate has been thus *coked*, it is pushed back, and a fresh feed introduced in front. The coal thus pushed back soon becomes vividly ignited, and by continuing this process, the fuel spread over the grate is maintained in the most active state of combustion at the hinder part of the grate. By such an arrangement, the smoke produced by the combustion of the fuel may be burnt before it enters the flues. The flame and heated air proceeding from the burning fuel arising from the grate, and rushing toward the back of the furnace, passes over the *fire-bridge* E, and is carried through the flue F which passes under the boiler. This flue (the cross section of which is shown in fig. 54, by the dark shade put under the boiler) is very nearly equal in width to the bottom of the boiler, the space at the bottom of the boiler, near the corners, being only what is sufficient to give the weight of the boiler support on the masonry forming the sides of the flue. The bottom of the boiler being concave, the flame and heated air as they pass along the flue rise to the upper part by the effects of their high temperature, and *lick* the bottom of the boiler from the fire-bridge at E to the further end G.

At G the flue arises to H, and turning to the side of the boiler at I I, con-

Fig. 55.

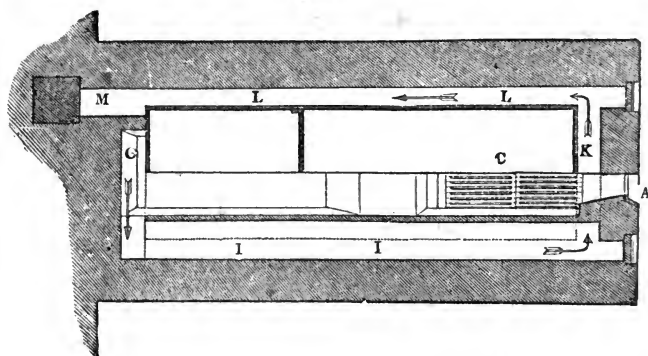

ducts the flame in contact with the side from the back to the front; it then passes through the flue K across the front, and returns to the back by the other side-flue L. The side-flue is represented, stripped of the masonry, in fig. 52, and also appears in the plan in fig. 55, and in the cross section in fig. 54. The course of the air is represented in fig. 55, by the arrows. From the flue L the air is conducted into the chimney at M.

By such an arrangement, the flame and heated air proceeding from the grate are made to circulate round the boiler, and the length and magnitude of the flues through which it is conducted should be such, that when it shall arrive at the chimney its temperature shall be reduced, as nearly as is consistent with the maintenance of draught in the chimney, to the temperature of the water with which it is in contact.

The method of feeding the furnace, which has been described above, is one which, if conducted with skill and care, would produce a much more perfect combustion of the fuel than would attend the common method of filling the grate from the back to the front with fresh fuel, whenever the furnace is fed. This method, however, is rarely observed in the management of the furnace. It requires the constant attention of the stokers (such is the name given to those who feed the furnaces). The fuel must be supplied, not in large quantities, and at distant intervals, but in small quantities and more frequently. On the other hand, the more common practice is to allow the fuel on the grate to be in a great degree burned away, and then to heap on a large quantity of fresh fuel, covering over with it the burning fuel from the back to the front of the grate. When this is done, the heat of the ignited coal acting upon the fresh fuel introduced, expels the gases combined with it and, mixed with these, a quantity of carbon, in a state of minute division, forming an opaque black smoke. This is carried through the flues and drawn up the chimney. The consequence is, that not only a quantity of solid fuel is sent out of the chimney unconsumed, but the hydrogen and other gases also escape unburnt, and a proportional waste of the combustible is produced; besides which, the nuisance of an atmosphere filled with smoke ensues. Such effects are visible to all who observe the chimneys of steam-vessels, while the engine is in operation. When the furnaces are thus filled with fresh fuel, a large volume of dense black smoke is observed to issue from the chimney. This gradually subsides as the fuel on the grate is ignited, and does not reappear until a fresh feed is introduced.

This method of feeding, by which the furnace would be made to consume its own smoke, and the combustion of the fuel be rendered complete, is not

however free from counteracting effects. In ordinary furnaces the feed can only be introduced by opening the fire-doors, and during the time the fire-doors are opened a volume of cold air rushes in, which passing through the furnace is carried through the flues to the chimney. Such is the effect of this in lowering the temperature of the flues, that in many cases the loss of heat occasioned is greater than any economy of fuel obtained by the complete consumption of smoke. Various methods, however, may be adopted by which fuel may be supplied to the grate without opening the fire-doors, and without disturbing the supply of air to the fire. A hopper built into the front of the furnace, with a moveable bottom or valve, by which coals may be allowed to drop in from time to time upon the front of the grate, would accomplish this.

In order to secure the combustion of the gases evolved from the coals placed in the front of the grate, it is necessary that a supply of atmospheric air should be admitted with them over the burning fuel. This is effected by small apertures or regulators, provided in the fire-doors, governed by sliding-plates, by which they may be opened or closed to any required extent.

A patent has recently been granted to Mr. Williams, one of the directors of the city of Dublin steam navigation company, for a method of consuming the unburnt gases which escape from the grate, and are carried through the flues. This method consists in introducing into the flue tubes placed in a vertical position, the lower ends of which being inserted in the bottom of the flue are made to communicate with the ash-pit, and the upper ends of which are closed. The sides and tops of these tubes are pierced with small holes, through which atmospheric air drawn from the ash-pit issues in jets. The oxygen supplied by this air immediately combines with the carburetted hydrogen, which having escaped from the furnace unburnt is carried through the flues at a sufficient temperature to enter into combination with the oxygen admitted through holes in the tubes. A number of jets of flame thus proceed from these holes, having an appearance similar to the flame of a gas-lamp.

It is evident that such tubes must be inefficient unless they are placed in the flues so near the furnace, that the temperature of the unburnt gases shall be sufficiently high to produce their combustion.

The magnitude of the grate and ash-pit must be determined by the rate at which the evaporation is required to be conducted in the boiler and the quality of the fuel. It must be a matter of regret, that the proportions of the various parts of steam-engines, with their boilers and furnaces, have not been determined by any exact or satisfactory experiments; and those who project and manufacture the engines themselves, are not less in ignorance on those points than others. With coals of the common quality a certain average proportion must exist between the necessary magnitude of the grate-surface and the quantity of water to be evaporated in a given time in the boiler. But what that proportion is for any given quality of fuel, is at present unascertained. Each engine-maker follows his own rule, and the rule thus followed is in most cases a matter of bare conjecture, unsupported by any experimental evidence. Some engine-makers will allow a square foot of grate-surface for every cubic foot of water per hour, which is expected to be evaporated in the boiler; others allow only half a square foot; and practice varies between these limits. Bituminous coals which melt and cake, and which burn with much flame and smoke, must be spread more thinly on the grate than other descriptions of fuel, otherwise a considerable quantity of combustible gases would be dismissed into the flues unburnt. Such coals therefore, other circumstances being the same, require a larger portion of grate-surface; and the same may be said of coals which produce clinkers in their combustion, and form lumps of vitrified matter on the grate, by which the spaces between the grate-bars

are speedily closed up. When such fuel is used, the grate-bars require to be frequently raked out, otherwise the spaces between them being obstructed, the draught would become insufficient for the due combustion of the fuel.

To facilitate the raking out of the grate, the bars are placed with their ends toward the fire-door: they are usually made of cast-iron, from two to two inches and a half wide on the upper surface, with intervals of nearly half an inch between them. The bars taper downward, their under surfaces being much narrower than their upper, the spaces between them thus widening, to facilitate the fall of the ashes between them. The grate-bars slope downward from the front to the back. The height of the centre of the bottom of the boiler, above the front of the grate, is usually about two feet, and about three feet above the back of it. The concave bottom of the boiler, however, brings its surfaces at the slide closer to the grate.

Between the evaporating power of the boiler, and the magnitude of surface it exposes to the action of the furnace, there is a relation which, like that of the grate surface, has never been ascertained by any certain or satisfactory experimental investigation; much less have the different degrees of efficiency attending different parts of the boiler-surface been determined. That part of the surface of the boiler immediately over and around the grate, is exposed to the immediate radiation of the burning fuel, and is therefore probably the most efficient in the production of steam. The tendency of flame and heated air to rise, would naturally bring them in the flues into closer contact with those parts of the boiler-surface which are horizontal in their position, and which form the tops of the flues, than with those which are lateral or vertical in their position, and which form the sides of the flues. In a boiler constructed like that already described, the flue-surface, therefore, which would be most efficient, would be the concave bottom of the boiler extending from the fire-bridge to its remote end. In some boilers, especially those in which steam of high pressure is produced, the form is cylindrical, the middle flue being formed into an elliptical tube the greater axis of which is horizontal from end to end of the boiler. It seems doubtful, however, whether in such a boiler the heat produces any useful effect on the water below the flue, the water above being always at a higher temperature, and therefore lighter than that below, and consequently no currents being established between the upper and lower strata of the water.

It was considered by Mr. Watt, but we are not aware on what experimental grounds, that from eight to ten square feet of heating surface were sufficient to produce the evaporation of one cubic foot of water per hour. The practice of engine-makers since that time has been to increase the allowance of heating surface for the same rate of evaporation. Engine-builders have varied very much in this respect, some allowing twelve, fifteen, and even eighteen square feet of surface for the same rate of evaporation. It must, however, still be borne in mind, that whether this increased allowance did or did not produce the actual evaporation imputed to it, has not been, as far as we are informed, ever accurately ascertained. The production of a given rate of evaporation by a moderate heat diffused over a larger surface, rather than by a fiercer temperature confined to a smaller surface, is attended with many practical advantages. The plates of the boiler acted upon by the fire are less exposed to oxydization, and the boiler will be proportionally more durable.

Besides presenting to the action of the fire a sufficient surface to produce steam at the required rate, the capacity of the boiler must be proportioned to the quantity of water to be evaporated. The space within the boiler is appropriated to a twofold purpose: first, to contain the water to be evaporated; secondly, to contain a quantity of ready-made steam for the supply of the cylinder. If the space appropriated to the steam did not bear a considerable pro-

portion to the magnitude of the cylinder, the momentary expansion of the steam passing to the cylinder from the boiler at each stroke would reduce the pressure of the steam in a great proportion, and unless the pressure in the boiler were considerably greater than that which the steam is intended to have in the cylinder, the pressure in the latter would be reduced below the proper amount. The proportion of the steam-space in the boiler to the magnitude of the cylinder has been very variously estimated, nor can it be said that any practical rule of a general kind has been adopted. It is held by some that the steam-space will be sufficient if it contain five times the quantity of steam consumed at each stroke, while others maintain that it should contain at least ten times that quantity, and opinions vary between these limits.

The proportion of water-space in the boiler to its evaporating power should also be regulated, so that the introduction of the feed at a comparatively low temperature may not unduly chill the water in the boiler. Supposing the feed to be introduced in a low-pressure boiler at the temperature of 100° , and that the necessary temperature within the boiler be 225° , the quantity of water it contains should be about five times the quantity evaporated, and therefore also five times the quantity introduced through the feed per hour. For every cubic foot of water per hour, therefore, intended to be evaporated by the boiler, water-space for five cubic feet should be provided. It is, however, right to repeat that this (like almost every other so-called rule) is the result, not of any exact general calculation, but one deduced from the custom which has obtained among the manufacturers of steam-engines.

The surface of the water in the boiler should always be above the range of the flues. When the heated air in the flues acts upon a part of the boiler within which water is contained, the water within receiving an increased temperature becomes, bulk for bulk, lighter than the strata of water above it, and ascends. It is replaced by the descending strata, which, in their turn receiving increased temperature, rise to the surface; or if the action of the heat convert the water into steam, the bubbles of steam rise to the surface, fresh portions of water continually coming into contact with the boiler-plates on which the heated air or flame acts. By this process the boiler-plates are continually cooled, either by being successively washed by water at a lower temperature, or by the heat taken from them becoming latent in the steam-bubbles formed in contact with them. But if the heat act upon a part of the boiler containing steam within it, which steam being a slow recipient of heat, and no currents being established, nor any phenomenon produced in which heat is rendered latent, the heat of the fire communicated to the boiler-plates accumulates in them, and raises their temperature to an injurious degree. The plates may by this means be softened, so as to cause the boiler to burst, or the difference between the expansion of the highly-heated plates thus exposed to fire in contact with steam and that of the plates which are cooled by contact with water, may cause the joinings of the boiler-plates to open, and the boiler to leak. By whatever means, therefore, the boiler be fed, care should be taken that the evaporation should not be allowed to reduce the level of the water in it below the highest flue.

As the water by which the boiler is fed must always have a much lower temperature than that at which the boiler is maintained, the supply of the feed will have a constant tendency to lower the temperature of the water, and this tendency will be determined by the proportion between the magnitude of the feed and the quantity of water in the boiler.

Since it is requisite that the level of the water in the boiler shall not suffer any considerable change, it is evident that the magnitude of the feed must be equal to the quantity of water evaporated. If it were less, the level of the

water would continually fall by reason of the excess of the evaporation over the feed; and if it were greater, the level would rise by the accumulation of water in the boiler. If, therefore, the quantity of water-space allowed in the boiler be five times the volume of water evaporated per hour, the quantity introduced by the feed per hour, whether continuously or at intervals, must be of the same amount. Since the process of evaporation is continuous, the variation of level of water in the boiler will be entirely dependent on the intervals between the successive feeds. If the feed be continuous, and always equal to the evaporation, then the level of the water in the boiler will undergo no change; but if, while the evaporation is continuous, the feed be made at intervals, then the change of level of water in the boiler as well as its change of temperature, will be subject to a variation proportional to the intervals between the successive feeds. It is manifest, therefore, that the feed should either be uninterrupted or be supplied at short intervals, so that the change of level and temperature of the water in the boiler should not be considerable.

Different methods have been, from time to time, suggested for indicating the level of the water in the boiler. We have already mentioned the two gauge-pipes used in the earlier steam-engines, and which are still generally continued. There are, however, some other methods which merit our attention.

A weight *F*, fig. 56, half immersed in the water in the boiler, is supported

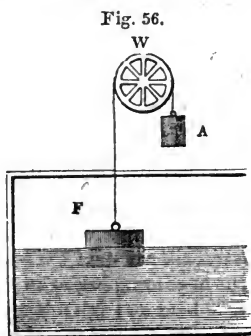

by a wire, which, passing steam-tight through a small hole in the top, is connected by a flexible string or chain, passing over a wheel *W*, with a counterpoise *A*, which is just sufficient to balance *F* when half immersed. If *F* be raised above the water, *A* being lighter will no longer balance it, and *F* will descend, pulling up *A*, and turning the wheel *W*. If, on the other hand, *F* be plunged deeper in the water, *A* will more than balance it, and will pull it up, so that the only position in which *F* and *A* will balance each other is, when *F* is half immersed. The wheel *W* is so adjusted, that when two pins placed on its rim are in the horizontal position, the water is at its proper level. Consequently it follows, that if the water rise above this level, the weight *F* is lifted and *A* falls, so that the pins come into another position. If, on the other hand, the level of the water fall, *F* falls and *A* rises, so that the pins assume a different position. Thus, in general, the position of the pins becomes an indication of the quantity of water in the boiler.

Another method is to place a glass tube, fig. 57, with one end *T* entering the boiler above the proper level, and the other end *T'* entering it below the proper level. It must be evident that the water in the tube will always stand

Fig. 57.

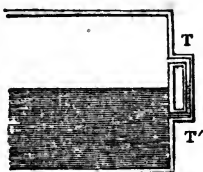

at the same level as the water in the boiler, since the lower part has a free communication with that water, while the surface is submitted to the pressure of the same steam as the water in the boiler. This and the last-mentioned gauge have the advantage of addressing the eye of the engineer at once, without any adjustment; whereas, the gauge-cocks must be both opened, whenever the depth is to be ascertained.

These gauges, however, require the frequent attention of the engine-man; and it becomes desirable either to find some more effectual means of awakening that attention, or to render the supply of the boiler independent of any attention. In order to enforce the attention of the engine-man to replenish the boiler when partially exhausted by evaporation, a tube was sometimes inserted at the lowest level to which it was intended that the water should be permitted to fall. This tube was conducted from the boiler into the engine-house, where it terminated in a mouth-piece or whistle, so that whenever the water fell below the level at which this tube was inserted in the boiler, the steam would rush through it, and issuing with great velocity at the mouth-piece, would summon the engineer to his duty with a call that would rouse him even from sleep.

In the most effectual of these methods, the task of replenishing the boiler should still be executed by the engineer; and the utmost that the boiler itself was made to do, was, to give due notice of the necessity for the supply of water. The consequence was, among other inconveniences, that the level of the water was subject to constant variation.

To remedy this, a method has been invented, by which the engine is made to feed its own boiler. The pipe G, fig. 58, which leads from the hot-water

Fig. 58.

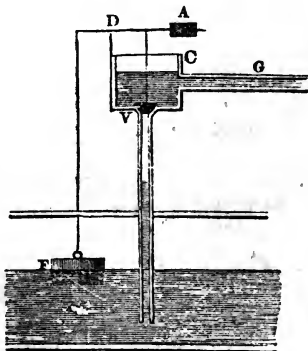

pump, terminates in a small cistern C in which the water is received. In the bottom of this cistern, a valve V is placed, which opens upward, and communicates with a feed-pipe, which descends into the boiler below the level of the

water in it. The stem of the valve *V* is connected with a lever turning on the centre *D*, and loaded with a weight *F* dipped in the water in the boiler in a manner similar to that described in fig. 56, and balanced by a counterpoise *A* in exactly the same way. When the level of the water in the boiler falls, the float *F* falls with it, and pulling down the arm of the lever raises the valve *V*, and lets the water descend into the boiler from the cistern *C*. When the boiler has thus been replenished, and the level raised to its former place, *F* will again be raised, and the valve *V* closed by the weight *A*. In practice, however, the valve *V* adjusts itself by means of the effect of the water on the weight *F*, so as to permit the water from the feeding-cistern *C* to flow in a continued stream, just sufficient in quantity to supply the consumption from evaporation, and to maintain the level of the water in the boiler constantly the same.

By this arrangement the boiler is made to replenish itself, or, more properly speaking, it is made to receive such a supply, as that it never wants replenishing—an effect which no effort of attention on the part of an engine-man could produce. But this is not the only good effect produced by this contrivance. A part of the steam which originally left the boiler, and having discharged its duty in moving the piston, was condensed and reconverted into water, and lodged by the air-pump in the hot well, fig. 58, is here again restored to the source from which it came, bringing back all the unconsumed

Fig. 59.

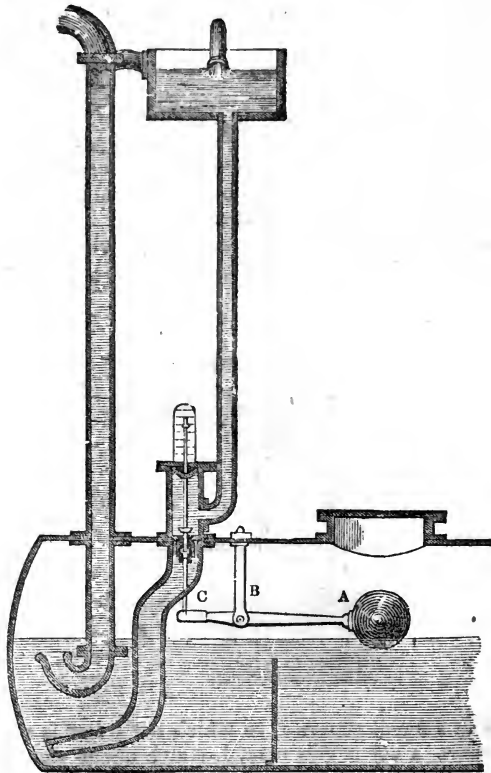

portion of its heat preparatory to being once more put in circulation through the machine.

The entire quantity of hot water pumped into the cistern C, is not always necessary for the boiler. A waste-pipe may be provided for carrying off the surplus, which may be turned to any purpose for which it may be required; or it may be discharged into a cistern to cool, preparatory to being restored to the cold cistern, in case water for the supply of that cistern be not sufficiently abundant.

Another method of arranging a self-regulating feeder is shown in fig. 59. A is a hollow ball of metal attached to the end of a lever, whose fulcrum is at B. The other arm of the lever C is connected with the stem of a spindle-valve, communicating with a tube which receives water from the feeding-cistern. Thus, when the level of the water in the boiler subsides, the ball A preponderating over the weight of the opposite arm, the lever falls, the arm C rises and opens the valve, and admits the feeding-water. This apparatus will evidently act in the same manner and on the same principle as that already described.

The mouth of the tube by which the feed is introduced should be placed at that part of the boiler which is nearest the end of the flues which issue into the chimney. By such means the temperature of the water in contact with those flues will be lowest at the place where the temperature of the heated air intended to act upon it is also lowest. The difference of the temperatures will therefore be greater than it would be if the point of the boiler containing water of a higher temperature was left in contact with this part of the flue.

It is necessary to have a ready method of ascertaining at all times the pressure of the steam which is used in working the engine. For this purpose a bent tube containing mercury is inserted into some part of the apparatus, which has free communication with the steam. Let A B C, fig. 60, be such a tube.

Fig. 60.

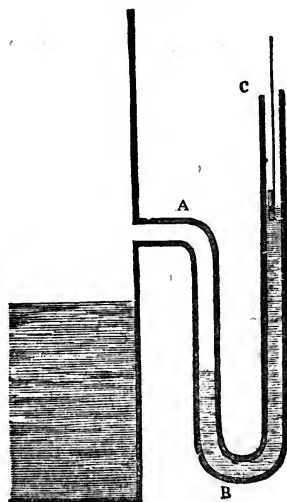

The pressure of the steam forces the mercury down in the leg A B, and up in the leg B C. If the mercury in both legs be at exactly the same level, the pressure of the steam must be exactly equal to that of the atmosphere, because

the steam-pressure on the mercury in A B balances the atmospheric pressure on the mercury in B C. If, however, the level of the mercury in B C be above the level of the mercury in B A, the pressure of the steam will exceed that of the atmosphere. The excess of its pressure above that of the atmosphere may be found by observing the difference of the level of the mercury in the tubes B C and B A, allowing a pressure of one pound on each square inch for every two inches in the difference of the levels.

If, on the contrary, the level of the mercury in B C should fall below its level in A B, the atmospheric pressure will exceed that of the steam, and the quantity of the excess may be ascertained exactly in the same way.

If the tube be glass, the difference of levels of the mercury would be visible; but it is most commonly made of iron; and in order to ascertain the level, a thin wooden rod with a float is inserted in the open end of B C, so that the portion of the stick within the tube indicates the distance of the level of the mercury from its mouth. A bulb or cistern of mercury might be substituted for the leg A B, as in the common barometer. This instrument is called the *steam-gauge*.

If the steam-gauge be used as a measure of the strength of the steam which presses on the piston, it ought to be on the same side of the throttle-valve (which is regulated by the governor) as the cylinder; for if it were on the same side of the throttle-valve with the boiler, it would not be affected by the changes which the steam may undergo in passing through the throttle-valve, when partially closed by the agency of the governor.

For boilers in which steam of very high pressure is used, as in those of locomotive engines, a steam-gauge, constructed on the above principle, would have inconvenient or impracticable length. In such boilers the pressure of the steam is equal to four or five times that of the atmosphere, to indicate which the column of mercury in the steam-gauge would be four or five feet in height. In such cases a thermometer-gauge may be used with advantage. The principle of this gauge is founded on the fact, that between the pressure and temperature of steam produced in contact with water there is a fixed relation, the same temperature always corresponding to the same pressure. If, therefore, a thermometer be immersed in the boiler which shall show the temperature of the steam, a scale may be attached to it, on which shall be engraved the corresponding pressures. Such gauges are now very generally used on locomotive engines.

The force with which the piston is pressed depends on two things: 1st, the actual strength of the steam which presses on it; and, 2dly, on the actual strength of the vapor which resists it. For although the vacuum produced by the method of separate condensation be much more perfect than what had been produced in the atmospheric engines, yet still some vapor of a small degree of elasticity is found to be raised from the hot water in the bottom of the condenser before it can be extracted by the air-pump. One of these pressures is indicated by the steam-gauge already described; but still, before we can estimate the force with which the piston descends, it is necessary to ascertain the force of the vapor which remains uncondensed, and resists the motion of the piston. Another gauge, called the barometer-gauge, is provided for this purpose. A glass tube A B, fig. 61, more than thirty inches long and open at both ends, is placed in an upright or vertical position, having the lower end B immersed in a cistern of mercury C. To the upper end is attached a metal tube, which communicates with the condenser, in which a constant vacuum, or rather high degree of rarefaction, is sustained. The same vacuum must therefore exist in the tube A B, above the level of the mercury, and the atmospheric pressure on the surface of the mercury in the cistern C will force

Fig. 61.



the mercury up in the tube A B, until the column which is suspended in it is equal to the difference between the atmospheric pressure and the pressure of the uncondensed steam. The difference between the column of mercury sustained in this instrument and in the common barometer, will determine the strength of the uncondensed steam, allowing a force proportional to one pound per square inch for every two inches of mercury in the difference of the two columns. In a well-constructed engine which is in good order, there is very little difference between the altitude in the barometer-gauge and the common barometer.

To compute the force with which the piston descends, thus becomes a very simple arithmetical process. First, ascertain the difference of the levels of the mercury in the steam-gauge; this gives the excess of the steam pressure above the atmospheric pressure. Then find the height of the mercury in the barometer-gauge; this gives the excess of the atmospheric pressure above the uncondensed steam. Hence, if these two heights be added together, we shall obtain the excess of the impelling force of the steam from the boiler, on the one side of the piston, above the resistance of the uncondensed steam on the other side: this will give the effective impelling force. Now, if one pound be allowed for every two inches of mercury in the two columns just mentioned, we shall have the number of pounds of impelling pressure on every square inch of the piston. Then, if the number of square inches in the section of the piston be found, and multiplied by the number of pounds on each square inch, the force with which it moves will be obtained.

From what we have stated it appears that, in order to estimate the force with which the piston is urged, it is necessary to refer to both the barometer and the steam-gauge. This double computation may be obviated by making one gauge serve both purposes. If the end C of the steam-gauge, fig. 60, instead of communicating with the atmosphere were continued to the condenser, we should have the pressure of the steam acting upon the mercury in the tube B A, and the pressure of the uncondensed vapor which resists the piston acting on the mercury in the tube B C. Hence the difference of the levels of the mercury in the tubes would at once indicate the difference between the force of the steam and that of the uncondensed vapor, which is the effective force with which the piston is urged.

But these methods of determining the effective force by which the piston is urged, can only be regarded as approximations, and not very perfect ones. If the condensation of steam on one side of the piston were instantaneously effected, or the uncondensed vapor were of the same tension during the whole stroke; and if, besides this, the pressure of steam on the piston were of uniform intensity from the beginning to the end of the stroke, then the steam and barometer gauges taken together would become an accurate index of the effec-

tive force of steam on the piston : but such is not the case. When the steam is first admitted through the steam-valve it acts on the piston with a pressure which is first slightly diminished, and afterward a little increased, until it arrives at that part of the stroke at which the steam valve is closed, after which the pressure is diminished. The pressure, therefore, urging the piston is subject to variation ; but the pressure of the uncondensed vapor on the other side of the piston is subject to still greater change. At the moment the exhausting-valve is opened, the piston is relieved from the pressure upon it by the commencement of the condensation ; but this process during the descent of the piston is gradual, and the vacuum is rendered more and more perfect, until the piston has nearly attained the limit of its play. These variations, both as well of the force urging the piston as of the force resisting it, are such as not to be capable of being accurately measured by a mercurial column, since they would produce oscillations in such a column, which would render any observations of its mean height impracticable.

To measure the mean efficient force of the piston, taking into account these circumstances, Mr. Watt invented an instrument, which, like all his mechanical inventions, has answered its purpose perfectly, and is still in general use. This instrument, called an *indicator*, consists of a cylinder of about $1\frac{3}{4}$ inch in diameter, and 8 inches in length. It is bored with great accuracy, and fitted with a solid piston moving steam-tight in it with very little friction. The rod of this piston is guided in the direction of the axis of the cylinder through a collar in the top, so as not to be subject to friction in any part of its play. At the bottom of the cylinder is a pipe governed by a stop-cock and turned in a screw, by which the instrument may be screwed on the top of the steam-cylinder of the engine. In this position, if the stop-cock of the indicator be opened, a free communication will be made between the cylinder of the indicator and that of the engine. The piston-rod of the indicator is attached to a spiral spring, which is capable of extension and compression, and which by its elasticity is capable of measuring the force which extends or compresses it in the same manner as a spring steel-yard or balance. If a scale be attached to the instrument at any point on the piston-rod to which an index might be attached, then the position of that index upon the scale would be governed by the position of the indicator-piston in its cylinder. If any force pressed the indicator-piston upward, so as to compress the spring, the index would rise upon the scale ; and if, on the other hand, a force pressed the indicator-piston downward, then the spiral spring would be extended, and the index on the piston-rod descend upon the scale. In each case the force of the spring, whether compressed or extended, would be equal to the force urging the indicator-piston, and the scale might be so divided as to show the amount of this force.

Now, let the instrument be supposed to be screwed upon the top of the cylinder of a steam-engine, and the stop-cock opened so as to leave a free communication between the cylinder of the indicator below its piston and the cylinder of the steam-engine above the steam-piston. At the moment the upper steam-valve is opened, the steam rushing in upon the steam-piston will also pass into the indicator, and press the indicator-piston upward : the index upon its piston-rod will point upon the scale to the amount of pressure thus exerted. As the steam-piston descends, the indicator-piston will vary its position with the varying pressure of the steam in the cylinder, and the index on the piston-rod will play upon the scale, so as to show the pressure of the steam at each point during the descent of the piston.

If it were possible to observe and record the varying position of the index on the piston-rod of the indicator, and to refer each of these varying positions

to the corresponding point of the descending stroke, we should then be able to declare the actual pressure of the steam at every point of the stroke. But it is evident that such an observation would not be practicable. A method, however, was contrived by Mr. Southern, an assistant of Messrs. Boulton and Watt, by which this is perfectly effected. A square piece of paper, or card, is stretched upon a board, which slides in grooves formed in a frame. This frame is placed in a vertical position near the indicator, so that the paper may be moved in a horizontal direction backward and forward, through a space of fourteen or fifteen inches. Instead of an index a pencil is attached to the indicator of the piston-rod: this pencil is lightly pressed by a spring against the paper above mentioned, and as the paper is moved in a horizontal direction under the pencil, would trace upon the paper a line. If the pencil were stationary this line would be straight and horizontal, but if the pencil were subject to a vertical motion, the line traced on the paper moved under the pencil horizontally would be a curve, the form of which would depend on the vertical motion of the pencil. The board thus supporting the paper is put into connexion by a light cord carried over pulleys with some part of the parallel motion, by which it is alternately moved to the right and to the left. As the piston ascends or descends, the whole play of the board in the horizontal direction will therefore represent the length of the stroke, and every fractional part of that play will correspond to a proportional part of the stroke of the steam-piston.

The apparatus being thus arranged, let us suppose the steam-piston at the top of the cylinder commencing its descent. As it descends, the pencil attached to the indicator piston-rod varies its height according to the varying pressure of the steam in the cylinder. At the same time the paper is moved uniformly under the pencil, and a curved line is traced upon it from right to left. When the piston has reached the bottom of the cylinder, the upper exhausting-valve is opened, and the steam drawn off to the condenser. The indicator-piston being immediately relieved from a part of the pressure acting upon it descends, and with it the pencil also descends; but at the same time the steam-piston has begun to ascend, and the paper to return from left to right under the pencil. While the steam-piston continues to ascend, the condensation becomes more and more perfect, and the vacuum in the cylinder, and therefore also in the indicator, being gradually increased in power, the atmospheric pressure above the indicator-piston presses it downward and stretches the spring. The pencil meanwhile, with a paper moving under it from right to left, traces a second curve. As the former curve showed the actual pressure of the steam impelling the piston in its descent, this latter will show the pressure of the uncondensed steam raising the piston in its ascent, and a comparison of the two will exhibit the effective force on the piston. Fig. 62 represents such a diagram as

Fig. 62.

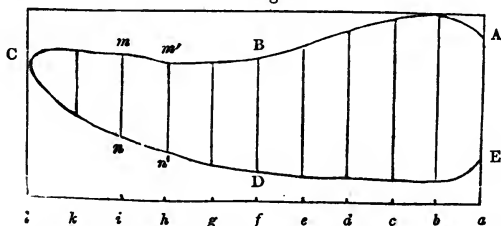

would be produced by this instrument. A B C is the curve traced by the pencil during the descent of the piston, and C D E that during its ascent. A

is the position of the pencil at the moment the piston commences its descent, B is its position at the middle of the stroke, and C at the termination of the stroke. On closing the upper steam-valve and closing the exhausting-valve, the indicator-piston being gradually relieved from the pressure of the steam the pencil descends, and at the same time the paper moving from left to right, the pencil traces the curve C D E, the gradual descent of this curve showing the progressive increase of the vacuum. As the atmospheric pressure constantly acts above the piston of the indicator, its position will be determined by the difference between the atmospheric pressure and the pressure of the steam below it; and therefore the difference between the heights of the pencil at corresponding points in the ascending and descending stroke, will express the difference between the pressure of the steam impelling the piston in the ascent and resisting it in the descent at these points. Thus at the middle of the stroke, the line B D will express the extent to which the spring governing the indicator-piston would be stretched by the difference between the force of steam impelling the piston at the middle of the descending stroke, and the force of steam resisting it at the middle of the ascending stroke. The force therefore measured by the line B D will be the effective force on the piston at that point; and the same may be said of every part of the diagram produced by the indicator.

The whole mechanical effect produced by the stroke of the piston being composed of the aggregate of all its varying effects throughout the stroke, the determination of its amount is a matter of easy calculation by the measurement of the diagram supplied by the indicator. Let the horizontal play of the pencil from A to C be divided into any proposed number of equal parts, say ten: at the middle of the stroke, B D expresses the effective force on the piston, and if this be considered to be uniform through the tenth part of the stroke, as from *f* to *g*, then the number of pounds expressed by B D multiplied by the tenth part of the stroke expressed in parts of a foot, will be the mechanical effect through that part of the stroke expressed in pounds' weight raised one foot. In like manner *m n* will express the effective force on the piston after three fourths of the stroke have been performed, and if this be multiplied by a tenth part of the stroke as before, the mechanical effect similarly expressed will be obtained; and the same process being applied to any successive tenth part of the stroke, and the numerical results thus obtained being added together, the whole effect of the stroke will be obtained, expressed in pounds' weight raised one foot.

By means of the indicator, the actual mechanical effect produced by each stroke of the engine can be obtained, and if the actual number of strokes made in any given time be known, the whole effect of the moving power would be determined. An instrument called a *counter* was also contrived by Watt, to be attached either to the working beam or to any other reciprocating part of the engine. This instrument consisted of a train of wheel-work with governing hands or indices moved upon divided dials, like the hands of a clock. A record of the strokes was preserved by means precisely similar to those by which the hands of a clock or timepiece indicated and recorded the number of vibrations of the pendulum or balance-wheel.

To secure the boiler from accidents arising from the steam contained in it acquiring an undue pressure, a safety-valve is used, similar in principle to those adopted in the early engines. This valve is represented in fig. 52, at N. It is a conical valve, kept down by a weight sliding on a rod upon it. When the pressure of the steam overcomes the force of this weight, it raises the valve and escapes, being carried off through the tube.

With a view to the economy of heat, this waste-steam tube is sometimes

conducted into the feeding cistern, where the steam carried off by it is condensed, and heats the feeding water.

The magnitude of the safety-valve should be such that, when open, steam should be capable of passing through it as rapidly as it is generated in the boiler. The superficial magnitude, therefore, of such valves must be proportional to the evaporating power of the boiler. In low-pressure boilers the steam is generally limited to five or six pounds' pressure per square inch, and consequently the load over the safety-valve in pounds would be found by multiplying the superficial magnitude of its smallest part by these numbers. In boilers in which the steam is maintained at a higher pressure, it would be inconvenient to place upon the safety-valve the necessary weight. In such cases a lever is used, the shorter arm of which presses down the valve, and the longer arm is held down by a weight capable of adjustment, so that the pressure on the valve may be regulated at discretion. Two safety-valves should be provided on all boilers, one of which should be locked up, so that the persons in care of the engine should have no power to increase the load upon it. In such case, however, it is necessary that a handle connected with the valve should project outside the box containing it, so that it may always be possible for the engineer to ascertain that the valve is not locked in its seat, a circumstance which is liable to happen.

Sometimes also two safety-valves are provided, one loaded a little heavier than the other. The escape of steam from the lighter valve in this case gives notice to the engine-man of the growing increase of pressure, and warns him to check the production of steam. The lever by which the safety-valve is held down is sometimes acted on by a spiral spring, capable of being so adjusted as to produce any required pressure on the valve. This arrangement is adopted in locomotive engines, where steam of very high pressure is used; and in such cases also there are always provided two such valves, one of which cannot be increased in its pressure.

The pipe by which the boiler is fed with water will necessarily act as a safety-valve, for when the pressure of the steam increases in an undue degree, it will press the water in the boiler up through the feed-pipe, so as to discharge it into the feed-cistern, a circumstance which would immediately give notice of the internal state of the boiler. The steam-gauge already described, fig. 60, would also act as a safety-valve; for if the pressure of steam in the boiler should be so augmented as to blow the mercury out of the steam-gauge, the steam would then issue through the gauge, and the pressure of the boiler be reduced, provided that the magnitude of the tube forming the steam-gauge were sufficient for this purpose.

In high-pressure boilers which are exposed to extreme temperatures and pressures, and which are therefore subject to danger of explosion, a plug of metal is sometimes inserted, which is capable of being fused at a temperature above which the boiler should not be permitted to be raised. If the pressure of steam increase beyond the proper limit, the temperature of the water and steam will undergo a corresponding increase; and if the metal of the plug be capable of being fused at such a temperature, the plug will fall out of the boiler, and the steam and water will issue from it. Various alloys of metal are fusible at temperatures sufficiently low for this purpose. An alloy composed of one part of lead, three of tin, and five of bismuth, will fuse at the common temperature of boiling water; and alloys of the same metals, in various proportions, will fuse at different temperatures from 200° to 400°.

Although fusible plugs may be used, in addition to other means of insuring safety, they ought not to be exclusively relied on at the ordinary working pressure of the boiler. The fusible plug ought to be capable of more than re-

sisting the pressure ; but if it be so, its point of fusion would be one at which the steam would have a pressure of at least two atmospheres above its working pressure. The plug would therefore be capable of being fused only as soon as the steam would acquire a pressure of 30 lbs. per inch above its regular working pressure.

When a boiler ceases to be worked, and the furnace has been extinguished, the space within it appropriated to steam will be left a vacuum by the condensation of the steam with which it was previously filled. The external pressure of the atmosphere acting on the boiler would, under such circumstances, have a tendency to crush it inward. To prevent this, a safety-valve is provided, opening inward, and balanced by a weight sufficient to keep it closed until it be relieved from the pressure of the steam below.

A large aperture closed by a flange secured with screws, represented at O in fig. 52, called the *man-hole*, is provided to admit persons into the boiler for the purpose of cleaning or repairing its interior.

The manner in which the governor regulates the supply of steam from the boiler to the cylinder, proportioning the quantity to the work to be done, and thereby sustaining a uniform motion, has been already explained. Since, then, the *consumption* of steam in the engine is subject to variation, owing to the various quantities of work it may have to perform, it is evident that the *production* of steam in the boiler should be subject to a proportional variation. For otherwise, one of two effects would ensue : the boiler would either fail to supply the engine with steam, or steam would accumulate in the boiler from being produced in too great abundance, and would escape at the safety-valve, and thus be wasted.

In order to vary the production of steam in proportion to the demands of the engine, it is necessary to stimulate or mitigate the furnace, as the evaporation is to be augmented or diminished.

The activity of the furnace must depend on the current of air which is drawn through the grate-bars, and this will depend on the magnitude of the space afforded for the passage of that current through the flues. A plate called a *damper* is accordingly placed with its plane at right angles to the flue, so that by raising and lowering it in the same manner as the sash of a window is raised or lowered, the space allowed for the passage of air through the flue may be regulated. This plate might be regulated by the hand, so that by raising or lowering it the draught might be increased or diminished, and a corresponding effect produced on the evaporation in the boiler : but the force of the fire is rendered uniformly proportional to the rate of evaporation by the following arrangement, without the intervention of the engineer. The column of water sustained in the feed-pipe (figs. 52, 53) represents by its weight the difference between the pressure of steam within the boiler and that of the atmosphere. If the engine consumes steam faster than the boiler produces it, the steam contained in the boiler acquires a diminished pressure, and consequently the column of water in the feed-pipe will fall. If, on the other hand, the boiler produce steam faster than the engine consumes it, the accumulation of steam in the boiler will cause an increased pressure on the water it contains, and thereby increase the height of the column of water sustained in the feed-pipe. This column therefore necessarily rises and falls with every variation in the rate of evaporation in the boiler. A hollow float P is placed upon the surface of the water of this column ; a chain connected with this float is carried upward, and passed over two pulleys, after which it is carried downward through an aperture leading to the flue which passes beside the boiler : to this chain is attached the damper. By such an arrangement it is evident that the damper will rise when the float P falls, and will fall when the float P rises, since the

weight of the damper is so adjusted, that it will only balance the float P when the latter rests on the surface of the water.

Whenever the evaporation of the boiler is insufficient, it is evident from what has been stated, that the float P will fall and the damper will rise, and will afford a greater passage for air through the flue. This will stimulate the furnace, will augment its heating power, and will therefore increase the rate of evaporation in the boiler. If, on the other hand, the production of steam in the boiler be more than is requisite for the supply of the engine, the float will be raised and the damper let down, so as to contract the flue, to diminish the draught, to mitigate the fire, and therefore to check the evaporation. In this way the excess, or defect, of evaporation in the boiler is made to act upon the fire, so as to render the heat proceeding from the combustion as nearly as possible proportional to the wants of the engine.

The method of feeding the furnace by hand through the fire-door being subject to the double objection of admitting more cold air over the fuel than is necessary for its combustion, and the impracticability of insuring that regular attendance on the part of the stokers, directed the attention of engineers to the construction of self-regulating furnaces. The most effectual of these, and that which has come into most general use, was invented by Mr. William Brunton, of Birmingham.

The advantages proposed to be attained by him were those expressed in his patent:—

“ 1. I put the coal upon the grate by small quantities, and at very short intervals, say every two or three seconds. 2. I so dispose of the coals upon the grate, that the smoke evolved must pass over that part of the grate upon which the coal is in full combustion, and is thereby consumed. 3. As the introduction of coal is uniform in short spaces of time, the introduction of air is also uniform, and requires no attention from the fireman.

“ As it respects economy: 1. The coal is put upon the fire by an apparatus driven by the engine, and so contrived that the quantity of coal is proportioned to the quantity of work which the engine is performing; and the quantity of air admitted to consume the smoke is regulated in the same manner. 2. The fire-door is never opened, excepting to clean the fire; the boiler, of course, is not exposed to that continual irregularity of temperature which is unavoidable in the common furnace, and which is found exceedingly injurious to boilers. 3. The only attention required is to fill the coal-receiver every two or three hours, and clean the fire when necessary. 4. The coal is more completely consumed than by the common furnace, as all the effect of what is termed ‘stirring up the fire’ (by which no inconsiderable quantity of coal is passed into the ash-pit), is attained without moving the coal upon the grate.”

A circular grate is placed on a vertical revolving shaft; on the lower part of this shaft, under the ash-pit, is placed a toothed wheel driven by a pinion. This pinion is placed on another vertical shaft, which ascends above the boiler; and on the other end of this is placed a bevelled wheel driven by a pinion. This pinion is attached to a shaft, which takes its motion from the axis of the fly-wheel, or any other revolving shaft connected with the engine. A constant motion of revolution is therefore imparted to the circular grate, and its velocity being proportional to that of the engine, will necessarily be also proportional to the quantity of fuel which ought to be consumed. Through that part of the boiler which is over the fire-grate a vertical tube or opening is made directly over that part of the furnace which is most distant from the flues. Over this opening a hopper is placed, which contains the fuel by which the boiler is to be fed; and in the bottom of this hopper is a sliding-valve, capable

of being opened or closed, so as to regulate the quantity of fuel supplied to the fire-grate. The fuel dropping in, in small quantities, through this open valve, falls on the grate, and is carried round by it, so as to leave a fresh portion of the grate to receive succeeding feeds. The coals admitted through the hopper are previously broken to a proper size; and in some forms of this apparatus there are two rollers, at a regulated distance asunder, the surfaces of which are formed into blunt angular points, and which are kept in slow revolution by the engine. Between these rollers the coals must pass before they reach the valve through which the furnace is fed, and they are thus broken and reduced to a regulated size. The valve which regulates the opening through which the feed is admitted, is connected by chains and pulleys with the self-regulating damper already described, so that in proportion as the damper is raised, the valve governing the feed may be opened. Thus, while the quantity of air admitted by the damper is increased according to the demands of the engine, the quantity of fuel admitted for the feed is increased by opening the valve in the bottom of the hopper in the same proportion. Apertures are also provided in the front of the grate, governed by regulators, by which the quantity of air necessary and sufficient to produce the combustion of the gas evolved from the fuel is admitted, these openings being also connected with the self-regulating damper.

A considerable portion of the heat imparted to the water in the boiler escapes by radiation from the surface of the boiler, steam-pipes, and other parts of the machinery in contact with the steam and hot water. The effects of this are rendered very apparent in marine-engines, where a large quantity of water is found to be condensed in the great steam pipes leading from the boiler to the cylinder. In stationary land-boilers this loss of heat is usually diminished, and in some cases in a great degree removed, by surrounding the boiler with iron-conducting substances. In some cases the boiler is built round in brick-work. In Cornwall, where the economy is regarded perhaps to a greater extent than elsewhere, the boiler and steam-pipes are surrounded with a packing of sawdust, which, being almost a non-conductor of heat, is impervious to the heat proceeding from the surfaces with which it is in contact, and consequently confines all the heat within the boiler. In marine-boilers it has been the practice recently to clothe the boiler and steam-pipes with a coating of felt, which is attended with a similar effect. When these remedies are properly applied, the loss of heat proceeding from the radiation of the boiler is reduced to an extremely small amount. The engine-houses of some of the Cornish engines, where the boiler generates steam at a very high temperature, are nevertheless frequently maintained at a lower temperature than the external air, and on entering them they have in a great degree the effect of a cave.

All mechanical action is measured by the amount of force exercised, or resistance overcome, and the space through which that force has acted, or through which the resistance has been moved.

The gross amount of mechanical action developed by the moving power of an engine, is expended partly on moving the engine itself, and partly on overcoming the resistance on which the engine is intended to act. That part of the mechanical energy of the moving power which is expended on the resistance or load which the engine moves exclusively, and of the power expended on moving the engine itself, is called *the useful effect* of the machine.

The *gross effect*, therefore, exceeds the *useful effect* by the amount of power spent in moving the engine, or which may be wasted or destroyed in any way by the engine.

It is usual to express and estimate all mechanical effect whatever by nature of the resistance overcome—by an equivalent weight raised a certain height. Thus, if an engine exerts a certain power in driving a mill, in drawing a carriage on a road, or in propelling a vessel on water, the resistance against which it has to act must be equal to a definite amount of weight. If a carriage be drawn, the traces are stretched by the tractive power, by the same tension that would be given to them if a certain weight were appended to them. If the paddle-wheels of a boat are made to revolve, the water opposes to them a resistance equal to that which would be produced, if, instead of moving the water, the wheel had to raise some certain weight. In any case, therefore, weight becomes the exponent of the energy of the resistance against which the moving power acts.

But the amount of mechanical effect depends conjointly on the amount of resistance, and the space through which that resistance is moved. The quantity of this effect, therefore, will be increased in the same proportion, whether the quantity of resistance, or the space through which that resistance is moved, be augmented. Thus, a resistance of one hundred pounds, moved through two feet, is mechanically equivalent to a resistance of two hundred pounds moved through one foot, or of four hundred pounds moved through six inches. To simplify, therefore, the expression of mechanical effect, it is usual to reduce it invariably to a certain weight raised one foot. If the resistance under consideration be equivalent to a certain weight raised through ten feet, it is always expressed by ten times the amount of that weight raised through one foot.

It has also been usual in the expression of mechanical effect, to take the pound weight as the unit of weight, and the foot as the unit of length, so that all mechanical effect whatsoever is expressed by a certain number of pounds raised one foot.

The gross effect of the moving power in a steam-engine, is the whole mechanical force developed by the evaporation of water in the boiler. A part of this effect is lost by the partial condensation of the steam before it acts upon the piston, and by the imperfect condensation of it subsequently; another portion is expended on overcoming the friction of the different moving parts, and in acting against the resistance which the air opposes to the machine. If the motion be subject to sudden shocks, a portion of the power is then lost by the destruction of momentum which such shocks produce. But if those parts of the machine which have a reciprocating motion be, as they ought to be, brought gradually to rest at each change of direction, then no power is absorbed in this way.

The useful effect of an engine is variously denominated according to the relation under which it is considered. If it be referred to the time during which it is produced, it is called **POWER**.

If it be referred to the fuel, by the combustion of which the evaporation has been effected, it is called **DUTY**.

When steam-engines were first brought into use, they were commonly applied to work pumps for mills which had been previously worked or driven by horses. In forming their contracts, the first steam-engine builders found themselves called upon to supply engines capable of executing the same work as was previously executed by some certain number of horses. It was therefore convenient, and indeed necessary, to be able to express the performance of these machines by comparison with the animal power to which manufacturers, miners, and others, had been so long accustomed. When an engine, therefore, was capable of performing the same work in a given time as any given number of horses of average strength usually performed, it was said to be an

engine of so many horses' power. Steam-engines had been in use for a considerable time before this term had acquired any settled or uniform meaning, and the nominal power of engines was accordingly very arbitrary. At length, however, the use of steam-engines became more extended, and the confusion and inconvenience arising out of all questions respecting the performance of engines, rendered it necessary that some fixed and definite meaning should be assigned to the terms by which the powers of this machine were expressed. To have abandoned the term *horse-power*, which had been so long in use, would have been obviously inconvenient; nor could there be any objection to its continuance, provided all engine-makers, and all those who used engines, could be brought to agree upon some standard by which the unit of horse-power might be defined. The performance of a horse of average strength, working for eight hours a day, was therefore selected as a standard, or unit, of steam-engine power. Smeaton estimated that such an animal, so working, was capable of performing a quantity of work equal in its mechanical effect to 22,916 lbs. raised one foot per minute, while Desaguliers estimated the same power at 27,500 lbs. raised through the same height in the same time. The discrepancy between these estimates probably arose from their being made from the performances of different classes of horses. Messrs. Boulton and Watt caused experiments to be made with the strong horses used in the breweries in London, and from the result of these trials they assigned 33,000 lbs. raised one foot per minute, as the value of a horse's power. This is the unit of engine-power now universally adopted; and when an engine is said to be of so many horses' power, what is meant is, that that engine, in good working order and properly managed, is capable of moving a resistance equal to 33,000 lbs. through one foot per minute. Thus, an engine of ten-horse power is one that would raise 330,000 lbs. weight one foot per minute.

Whether this estimate of an average horse's power be correct or not, in reference to the actual work which the animal is capable of executing, is a matter of no present importance in its application to steam-power. The steam-engine is no longer used to replace the power of horses, and therefore no contracts are based upon such a comparison. The term horse-power, therefore, as applied to steam-engines, must be understood to have no reference whatever to the actual animal power, but must be taken as a term having no other meaning than the expression of the ability of the machine to move the amount of resistance above mentioned through one foot per minute.

It has been already explained that the conversion of a given volume of water into steam is productive of a certain definite amount of mechanical force, this amount depending on the pressure under which the water is evaporated, and the extent to which the expansive principle is used in working the steam. It is evident that this amount of mechanical effect is a major limit, which cannot be exceeded by the power of the engine.

If the steam be not worked expansively, then the whole power of the water, transmitted in the form of steam from the boiler to the working machinery, will be a matter of easy calculation, when the pressure at which the steam is worked is known. The following table exhibits the mechanical power of a cubic foot of water converted into steam at various pressures, expressed in an equivalent number of pounds' weight raised one foot high. Where much accuracy is sought for, the pressure at which the steam is used must be taken into account; but by reference to the table it will be seen, that when steam is worked without expansion, its mechanical effect varies very little with the pressure. It may therefore be assumed, as has already been stated, that for every cubic inch of water transmitted in the form of steam to the cylinders, a force is produced, represented by a ton weight raised a foot high. Now, as 33,000 lbs. is very

nearly 15 tons, it follows that 15 cubic inches of water converted into steam per minute, or 900 cubic inches per hour, will produce a mechanical force equal to one horse. If, therefore, to 900 cubic inches be added the quantity of water per hour necessary to move the engine itself, independently of its load, we shall obtain the quantity of water per hour which must be supplied by the boiler to the engine for each horse-power; and this will be the same, whatever may be the magnitude or proportions of the cylinder:—

Total pressure in pounds per square inch.	Corresponding temperature.	Volume of the steam compared to the volume of the water that has produced it.	Mechanical effect of a cubic inch of water evaporated in pounds raised one foot.	Total pressure in pounds per square inch.	Corresponding temperature.	Volume of the steam compared to the volume of the water that has produced it.	Mechanical effect of a cubic inch of water evaporated in pounds raised one foot.
1	102.9	20868	1739	58	292.9	484	2339
2	126.1	10874	1812	59	294.2	477	2343
3	141.0	7437	1859	60	295.6	470	2347
4	152.3	5685	1895	61	296.9	463	2351
5	161.4	4617	1924	62	298.1	456	2355
6	169.2	3897	1948	63	299.2	449	2359
7	175.9	3376	1969	64	300.3	443	2362
8	182.0	2983	1989	65	301.3	437	2365
9	187.4	2674	2006	66	302.4	431	2369
10	192.4	2426	2022	67	303.4	425	2372
11	197.0	2221	2036	68	304.4	419	2375
12	201.3	2050	2050	69	305.4	414	2378
13	205.3	1904	2063	70	306.4	408	2382
14	209.1	1778	2074	71	307.4	403	2385
15	212.8	1669	2086	72	308.4	398	2388
16	216.3	1573	2097	73	30.3	393	2391
17	219.6	1488	2107	74	310.3	388	2394
18	222.7	1411	2117	75	311.2	383	2397
19	225.6	1343	2126	76	312.2	379	2400
20	228.5	1281	2135	77	313.1	374	2403
21	231.2	1225	2144	78	314.0	370	2405
22	233.8	1174	2152	79	314.9	366	2408
23	236.3	1127	2160	80	315.8	362	2411
24	238.7	1084	2168	81	316.7	358	2414
25	241.0	1044	2175	82	317.6	354	2417
26	243.3	1007	2182	83	318.4	350	2419
27	245.5	973	2189	84	319.3	346	2422
28	247.6	941	2196	85	320.1	342	2425
29	249.6	911	2202	86	321.0	339	2427
30	251.6	883	2209	87	321.8	335	2430
31	253.6	857	2215	88	322.6	332	2432
32	255.5	833	2221	89	323.5	328	2435
33	257.3	810	2226	90	324.3	325	2438
34	259.1	788	2232	91	325.1	322	2440
35	260.9	767	2238	92	325.9	319	2443
36	262.6	748	2243	93	326.7	316	2445
37	264.3	729	2248	94	327.5	313	2448
38	265.9	712	2253	95	328.2	310	2450
39	267.5	695	2259	96	329.0	307	2453
40	269.1	679	2264	97	329.8	304	2455
41	270.6	664	2268	98	330.5	301	2457
42	272.1	649	2273	99	331.3	298	2460
43	273.6	635	2278	100	332.0	295	2462
44	275.0	622	2282	110	339.2	271	2486
45	276.4	610	2287	120	345.8	251	2507
46	277.8	598	2291	130	352.1	233	2527
47	279.2	586	2296	140	357.9	218	2545
48	280.5	575	2300	150	363.4	205	2561
49	281.9	564	2304	160	368.7	193	2577
50	283.2	554	2308	170	373.6	183	2593
51	284.4	544	2312	180	378.4	174	2608
52	285.7	534	2316	190	382.9	166	2622
53	286.9	525	2320	200	387.3	158	2636
54	288.1	516	2324	210	391.5	151	2650
55	289.3	508	2327	220	395.5	145	2663
56	290.5	500	2331	230	399.4	140	2675
57	291.7	492	2335	240	403.1	134	2687

The quantity of power expended in working the engine itself, independently of that required to move its load, will be less in proportion to the degree of perfection which may be attained in the construction of the engine, and to the order in which it is kept while working. Engines vary one from another so much in these respects, that it is scarcely possible to lay down any general rules for the quantity of power to be allowed over and above what is necessary to move the load. The means whereby mechanical power is expended in working the engine may be enumerated as follows:—

1. Steam in passing from the boiler to the cylinder is liable to lose its temperature by the radiation of the steam-pipes and other passages through which it is conducted. Since the steam produced in the boiler is in contact with water, it will be common steam, and consequently the least loss of heat will cause a partial condensation. To whatever extent this condensation may be carried, a proportional loss of power, in reference to the heat obtained from the fuel, will be entailed upon the engine.

It has been said that the force necessary to move the steam from the boiler to the cylinder through passages more or less contracted, subject to the friction of the pipes and tubes through which it moves, should be taken into account in estimating the power, and a corresponding deduction made. This, however, is not the case: the steam, having passed into the cylinder, remains common steam, its pressure being diminished by reason of the force expended in thus moving it from the boiler to the cylinder. But its mechanical efficacy at the reduced pressure is not sensibly different from the efficacy which it had in the boiler. If, at the reduced pressure, its volume were the same, then a loss of effect would be sustained equivalent to the difference of the pressures; but its volume being augmented in very nearly the same proportion as its pressure is diminished, the mechanical efficacy of a given weight of steam in the cylinder will be sensibly the same as in the boiler.

2. The radiation of heat from the cylinder and its appendages, will cause a partial condensation of steam, and thereby produce a diminished mechanical effect.

3. The steam, which at each stroke of the piston fills the passages between the steam-valves and the piston, at the moment the latter commences the stroke will be inefficient. If it were possible for the piston to come into steam-tight contact with each end of the cylinder, and that the steam-valve should be in immediate contact with the side or top of the piston, then the whole of the steam which would pass through the steam-valve would be efficient; but as some space, however small, must remain between the piston and the ends of the cylinder, and between the side of the cylinder and the steam-valve, there will always be a volume of steam bearing a sensible proportion to the magnitude of the cylinder, which at each stroke of the piston will be inefficient. This volume of steam is called the *clearance*.

4. Since the piston must move in steam-tight contact with the cylinder, it must have a definite amount of friction with the sides of the cylinder by whatever means it may be packed. This friction will produce a corresponding resistance to the moving power.

5. The various joints of the machinery where steam is contained are subject to leakage, and whatever amount of steam shall thus escape must be placed to the account of power lost.

6. When the eduction-valve is opened to admit the steam to the condenser, a certain force is required to expel the steam from the cylinder. This force reacts upon the piston, and counteracts to a proportional extent the moving power of the steam on the other side. Besides this the water in the condenser cannot be conveniently reduced below the temperature of about 100° , and

at this temperature steam has a pressure of about one pound per square inch. This vapor will continue to fill the cylinder, and will resist the moving power which impels the piston.

7. Power must be provided for opening and closing the valves or slides, for working the air-pump, hot-water pump, and cold-water pump, and finally to overcome the friction on the journals and centres of the parts of the parallel motion, the main axle of the beam, the connecting-rod, crank, and fly-wheel axle.

It will be apparent how very much these sources of resistances must vary in different engines, and how rough an approximation any general estimate must be of their gross amount.

There are many circumstances which obstruct the practical application of any standard of engine-power: the magnitude of furnace, and the extent of heating surface necessary to produce any required rate of evaporation in the boiler, are unascertained; each engine-maker has his own rule in these matters, and all the rules are equally unsupported by any experimental test entitled to respect. Thus the circumstances that govern the rate of evaporation in the boiler may be regarded as almost wholly unknown. But supposing the rate of evaporation to be ascertained, the amount of power absorbed by the condensation of steam on its passage to the cylinder, the imperfect condensation of the same steam after it has worked the piston, the friction of the various moving parts of the machinery, and, above all, the difference of effect of these losses of power in engines constructed on different scales of magnitude, are absolutely unknown. We are, therefore, not placed in a condition to assign anything more than a general account of what has been the practice of engine-makers in constructing engines which are nominally of a certain power.

In common low-pressure engines of the larger kind, to which class alone we at present refer, it has been usual, with the same fuel and under like circumstances, to allow from 10 to 18 square feet of heating surface in the boiler for every nominal horse-power of the engine. Within these wide limits the practice of engine-makers has varied. It is not, however, to be supposed that the boiler with 18 square feet of surface per horse-power has the same evaporating power as that which has but 10. This difference, therefore, amounts to nothing more than different manufacturers of steam-engines putting into circulation boilers having powers *really* different while they are *nominally* the same. The magnitude of the cylinder is regulated by the nominal power of the engine, and it is usual so to regulate the evaporating power of the boiler, that the piston shall move at the average rate of 200 feet per minute. This being assumed, it is customary to allow about 22 square inches of piston surface for every nominal horse-power of the engine. If this power were in conformity to the standard already defined, this amount of surface moved at 200 ft per minute would be impelled by a pressure amounting to $7\frac{1}{2}$ lbs. per square inch. The safety-valve of the boiler of such engines is usually loaded at from 4 to 5 lbs. per square inch, and consequently the steam in the boiler will have a pressure of from 19 to 20 lbs. per square inch. If, therefore, the effective pressure on the piston be really only $7\frac{1}{2}$ lbs. per square inch, the pressure expended in overcoming the friction of the engine, and the loss consequent on the partial condensation of steam on one side and its imperfect condensation on the other, would amount to from 12 to 13 lbs. per square inch, or nearly double the assumed useful effect of the engine.

Messrs. Maudslay and Field are accustomed to allow an evaporation of ten gallons, or 1.6 cubic feet of water per hour, for each nominal horse-power of the engine. They also allow about 22 square inches of piston-

surface per nominal horse-power, the piston being supposed to move at the rate of 200 feet per second.*

The quantity of grate-surface necessary in proportion to the power of the engine, has been equally unascertained, and engine-makers vary in their practice from half a square foot to one square foot per nominal horse-power.

The proportion which the magnitude of the heating-surface of the boiler, and the fire-surface of the grate bears to the evaporating power of the boiler, has not been determined by experiment, nor, so far as we are informed, by any well-ascertained practical results.

The estimates or rather conjectures of engine-makers, of the evaporation necessary to produce one-horse power, vary from one to two cubic feet of water per hour. It has been already shown that the evaporation of 900 cubic inches, or little more than half a cubic foot per hour, evolves a gross mechanical effect representing one horse-power; from which it appears, that if the evaporation of the boilers of steam-engines were what engineers suppose them to be, the gross mechanical power produced in them for every nominal horse power of the engine varies in actual amount from the power of two to that of four horses.

The above estimates must be understood as referring to double-acting steam-engines above thirty-horse power. The circumstances attending the performance of single-acting engines applied to the drainage of mines, have been ascertained with much greater precision. This has been mainly owing to a spirited system of general inspection which has been established in Cornwall, to which we shall hereafter more particularly advert.

In expressing the duty of engines, it would have been desirable that the duty of the boiler should have been separated from that of the engine.

The duty of a boiler is estimated by the volume of water evaporated by a given quantity of fuel, independently of the time which such evaporation may take. The duty, therefore, will be expressed by the number of cubic feet of water evaporated, divided by the number of bushels of coal necessary for that evaporation, supposing the bushel of coal to be the unit of fuel. It will be observed that the *duty* of an engine or boiler is entirely distinct from, and independent of, its *power*. One boiler may be greater than another in power to any extent, while it may be equal to or less than it in duty. A bushel of coals may evaporate the same number of cubic feet of water under two boilers, but may take twice as great a time to produce such evaporation under one than under the other. In such a case the power of one boiler will be double that of the other, while their duty will be the same.

In like manner, a bushel of coals consumed in working two engines may produce the same useful effect, but it may produce that useful effect in the one in half the time it takes to produce it in the other. In that case the *duty* of the engines will be the same, but the *power* of the one will be double that of the other.

In fine, *power* has reference to *time—duty*, to *fuel*. The more rapidly the engine produces its mechanical effect, the greater its power will be, whatever may be the fuel consumed in working it. And, on the other hand, the greater

* If 22 square inches of piston-surface be allowed to represent a horse-power, the power of an engine may always be computed by dividing the square of the diameter of the piston expressed in inches by 28. And, on the other hand, to find the diameter of piston which would correspond to any given power, multiply the number of horses' power by 28, and take the square root of the product. These rules, however, cannot be applied if the piston be supposed to move with any other velocity: since, in that case, the same amount of piston-surface would cease to represent a horse-power, unless the effective pressure on the piston were at the same time changed.

the useful effect produced by a given weight of fuel, the greater will be the duty, however long the time may be which the fuel may take to produce the useful effect.

The proportion of the stroke to the diameter of the cylinder must be determined by the velocity intended to be given to the piston. With the same capacity of cylinder, and the same evaporation in the boiler, the velocity of the piston will augment as the magnitude of its diameter is diminished.

The proportion of the diameter to the stroke of the cylinder is very various. In engines used for steam-vessels the length of the cylinder very little exceeds its diameter. In land-engines, however, the proportion of the length to the diameter is greater. It is maintained by some that the proportion of the diameter and length of the cylinder should be such as to render its surface exposed to the cooling of the external air, the smallest possible. Tredgold has maintained that since, during the stroke, the steam is gradually exposed to contact with the surface of the cylinder from the top to the bottom, the mean surface exposed in contact with steam being half that of the entire cylinder, the proportion of the diameter to the stroke should be such that the surface of half the length of the cylinder, added to the magnitude of the top and bottom, shall be a minimum. If this principle be admitted, then the best proportion of the diameter to the stroke would be that of one to two, the length of the stroke being twice the diameter of the cylinder; but since the whole surface of the cylinder is constantly exposed to the cooling effects of the air, and since in the intervals of the stroke there is no sensible change of the temperature of the surface, the loss of heat by cooling will in effect be the same, especially in double-acting engines, as if the cylinder were constantly filled with steam. If this be admitted, then the object should be to give the cylinder such a proportion, that its entire surface, including the top and bottom, shall be a minimum. The proportion given by this condition would be very nearly that which is observed in the cylinders of marine-engines, viz., that the length of the cylinder should be equal to its diameter.

If in a low-pressure engine the pressure of steam in the cylinder be taken at 17 lbs. per square inch, then the volume of steam will be about fifteen hundred times that of the water which produces it. For every cubic foot of water, therefore, in the effective evaporation of the boiler, 1,500 cubic feet of steam will be passed through the cylinder. If it be intended that the motion of the piston shall be at the rate of 25 strokes per minute, or 1,500 strokes per hour, then the capacity of that portion of the cylinder between the steam-valve and the piston at the end of the stroke, must consist of half as many cubic feet as there are cubic feet per hour evaporated in the boiler. If the steam, therefore, be cut off at half stroke, the number of cubic feet of space in the cylinder will be equal to the number of cubic feet of water effectively evaporated by the boiler; and if a cubic foot of water effectively evaporated be taken as the measure of a horse-power, then there would be as many cubic feet in the capacity of the cylinder as is equal to the nominal power of the engine.

The duty of engines varies according to their form and magnitude, the circumstances under which they are worked, and the purposes to which they are applied. In double-acting engines working without expansion, the coal consumed per nominal horse-power per hour varies from 7 to 12 lbs. An examination of the steam-logs of several government steamers made by me a few years since, gave, as the average of consumption of fuel at that time of the best class of marine-engines, about 8 lbs. per nominal horse-power per hour. Since, however, no account could be obtained of the actual evaporation of water in the

boiler, nor, with the necessary degree of precision, of the quantity and pressure of the steam which passed through the cylinders, this estimate must be regarded as an approximation subject to several causes of error. The question of the duty of boilers and engines applied to the general purposes of manufactures and navigation, is one which has not yet been satisfactorily investigated; and it were much to be desired that the proprietors of such engines should combine to establish a strict analysis of their performance in reference to their consumption of fuel, their evaporation of water, and their useful effects. The results of such an investigation, if properly conducted, would perhaps tend more to the improvement of the steam-engine than any discoveries in science, or inventions in mechanical detail, likely to be made in the present stage of the progress of that machine.

A strict investigation of this kind has been for many years carried on respecting the performance of the steam-engines used for the drainage of the mines in Cornwall; and it has been attended with effects the most beneficial to the interests of those concerned in them. The engines to which this important inquiry has been applied being used for the purpose of pumping, are generally single-acting engines, in which steam is used expansively to a great extent. The steam is produced under a very high pressure in the boiler, and being admitted to the cylinder is cut off after a small portion of the entire stroke has been made, the remainder of the stroke being produced by the expansion of the steam.

About the year 1811, a number of the proprietors of the principal Cornish mines agreed to establish this system of inspection, under the management and direction of Captain Joel Lean; and to publish monthly reports. In these reports were stated the following particulars: 1, the load per square inch on the piston; 2, the consumption of coal in bushels; 3, the number of strokes made by the engine; 4, the length of the strokes in the pumps; 5, the load in pounds; 6, the duty of the engine, expressed by the number of pounds raised one foot high by the consumption of a bushel of coals; 7, the number of strokes per minute; 8, the diameter and stroke of the cylinder, and a general description of the engine. When these reports were commenced, the number of engines brought under inspection was twenty-one. In the year 1813, it increased to twenty-nine; in 1814, to thirty-two; in 1820, the number reported upon increased to forty; in 1828, the number was fifty-seven; and in 1836, it was sixty-one. This gradual increase in the number of engines brought under the system of inspection, was produced by the good effects which attended it. These beneficial consequences were manifested, not only in the improved performance of the same engines thus reported upon, but in the gradually-improved efficiency of those which were afterward constructed.

The following table, taken from the statement of the duty of Cornish engines, will show in a striking manner the improvement of those engines, from the commencement of this system of inspection to the present time. The duty is expressed by the number of pounds raised one foot high by the consumption of a bushel of coals.

As an example of the beneficial effects produced upon the efficiency of an individual engine by the first application of this system of inspection, the case of the Stray Park engine may be mentioned. This engine, constructed by Boulton and Watt, had a sixty-inch cylinder, and when first reported in 1811, its duty amounted to 16,000,000 pounds. After having been reported on for three years, its duty was found to have increased to 32,000,000; this estimate being taken from the average result of twelve months' performance. Its duty was doubled in less than three years.

Years.	No. of engines.	Average duty of the whole.	Average duty of the best engine.
1812	21	19,300,000	
1813	29	19,500,000	26,400,000
1814	32	20,600,000	32,000,000
1815	35	20,500,000	28,700,000
1816	35	23,000,000	32,400,000
1817	35	26,500,000	41,600,000
1818	36	25,400,000	39,300,000
1819	40	26,300,000	40,000,000
1820	46	28,700,000	41,300,000
1821	45	28,200,000	42,800,000
1822	52	28,900,000	42,500,000
1823	52	28,200,000	42,100,000
1824	49	28,300,000	43,500,000
1825	56	32,000,000	45,400,000
1826	51	30,500,000	45,200,000
1827	51	32,100,000	59,700,000
1828	57	37,100,000	76,800,000
1829	53	41,700,000	77,000,000
1830	56	43,300,000	78,000,000
1831	58	43,400,000	71,100,000
1832	59	45,000,000	85,000,000
1833	56	46,600,000	84,300,000
1834	52	47,800,000	90,900,000
1835	51	47,800,000	91,700,000
1836	61	46,600,000	85,400,000
1837	58	47,000,000	87,200,000
1838	61	46,700,000	84,200,000

It will appear, by inspection of the duties registered in the preceding table, that the augmentation of the efficiency of the engines has not been the effect of any great or sudden improvement, but has rather resulted from the combination of a great number of small improvements in the details of the operation of these machines. In these improvements more is due to the successful application of practical experience than to any new principles developed by scientific research. Mr. John Taylor, in his "Records of Mining," has traced the successive improvements on which the increased duty of engines depends, and has connected these improvements with their causes in the order of their dates. The following results, abridged from his estimates, may not be uninteresting:—

In 1769, soon after the date of the earliest discoveries of Mr. Watt, but before they had come into practical application, Smeaton computed that the average duty of fifteen atmospheric engines, working at Newcastle-on-Tyne, was 5,590,000. The duty of the best of these engines was 7,440,000, and that of the worst 3,220,000.

In 1772, Smeaton commenced his improvements on the atmospheric engine, and raised the duty to 9,450,000.

In 1776, Watt obtained a duty of 21,600,000.

At this time Smeaton acknowledged that Watt's engines gave a duty amounting to double that of his own.

In 1778-'79, Watt reported a duty of 23,400,000.

From 1779 to 1788, Watt introduced the application of expansion, and raised the duty to 26,600,000.

In 1798, an engine by Boulton and Watt, erected at Herland, was reported as giving a duty of 27,000,000.

This engine, which was probably the best which at that time had ever

been erected, attracted the particular attention of Mr. Watt, who, on visiting Cornwall, went to see it, and had many experiments tried with it. It was under the care of Mr. Murdock, the agent of Messrs. Boulton and Watt in Cornwall. When Mr. Watt inspected it he pronounced it perfect, and that further improvement could not be expected. How singular an instance this of the impossibility, even of the most sagacious, to foresee the results of mechanical improvement! In twenty years afterward the average duty of the best engine was nearly 40,000,000, and in forty years it was above 84,000,000!

THE STEAM-ENGINE.

(FIFTH LECTURE.)

Railways.—Effects of Railway Transport.—History of the Locomotive Engine.—Construction of Locomotive Engine by Blinkinsop.—Messrs. Chapman's Contrivance.—Walking Engine.—Mr. Stephenson's Engines at Killingworth.—Liverpool and Manchester Railway.—Experimental Trial of the "Rocket," "Sanspareil," and "Novelty."—Method of Subdividing the Flue into Tubes.—Progressive Improvement of Locomotive Engines.—Adoption of Brass Tubes.—Detailed Description of the most Improved Locomotive Engines.—Power of Locomotive Engines.—Position of the Eccentrics.—Pressure of Steam in the Boiler.—Dr. Lardner's Experiments in 1838.—Resistance to Railway Trains.—Dr. Lardner's Experiments on the Great Western Railway.—Experiments on Resistance.—Restrictions on Gradients.—Compensating Effect of Gradients.—Experiment with the "Hecla."—Disposition of Gradients should be Uniform.—Methods of surmounting Steep Inclinations.

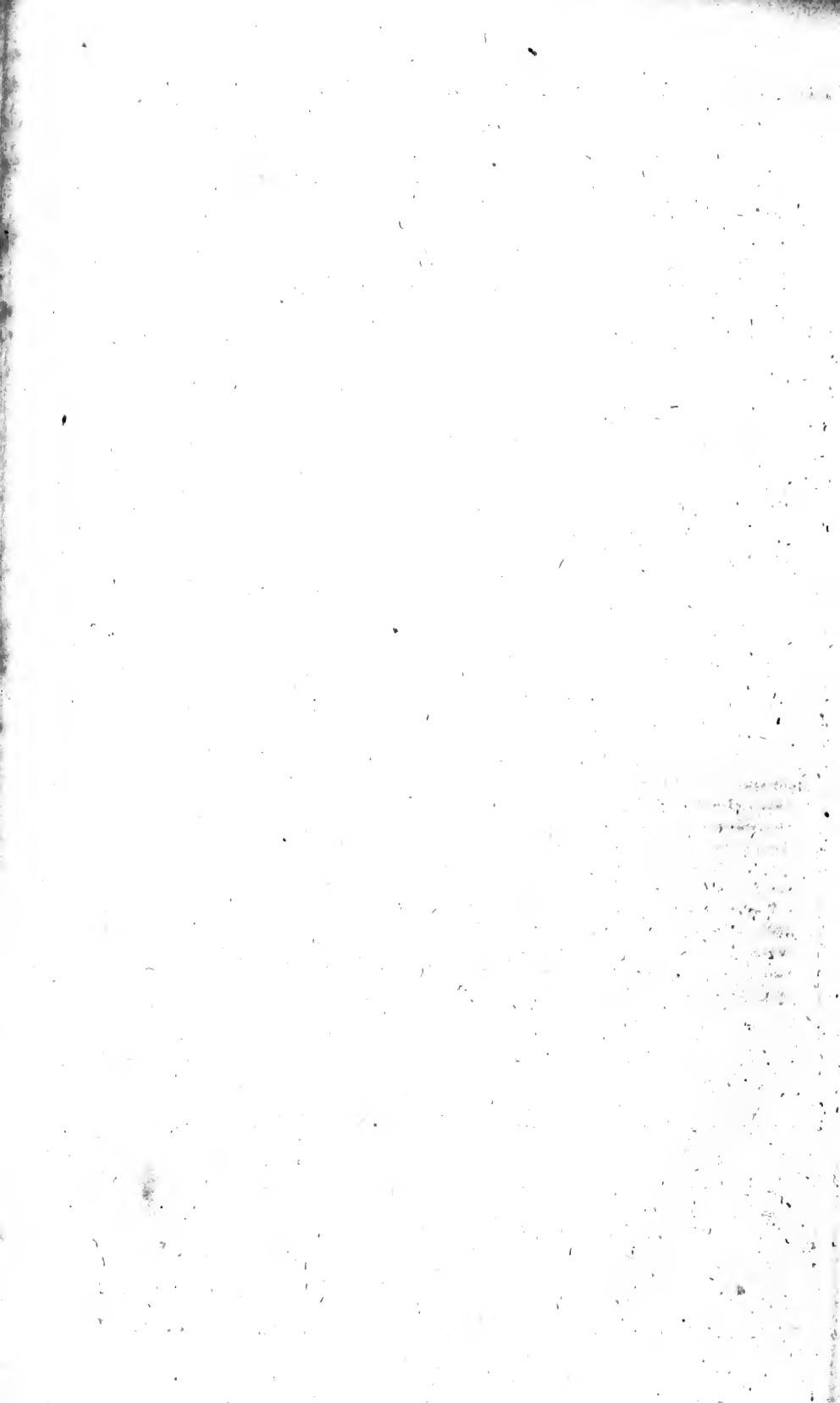

THE STEAM-ENGINE.

(FIFTH LECTURE.)

CAPITAL and labor have for the last twenty years been directed with extraordinary skill and energy to the improvement of inland transport, and this important element of national prosperity and civilization has received a proportionate impulse. Effects are now witnessed, which, had they been even hinted at as being within the compass of possibility twenty years ago, would have been scouted as the dreams of a disordered imagination; such, indeed, as no writer of fiction would have dared to give place to. Even so recently as twenty-five years since, who would have credited the possibility of a ponderous machine, weighing some twenty tons, carrying with it several tons of coal and water, flying over the country at the rate of fifty, or sixty, or seventy miles an hour, transporting some hundreds of passengers with their luggage! Yet such a spectacle is now of such ordinary occurrence in England, as to excite no astonishment. And the art of constructing the machinery by which these extraordinary results are obtained is so far from having reached maturity, that scarcely two practical men can be found to agree upon the mechanical conditions which shall best insure its efficiency. At the moment I address you, commissions have been confided in England and elsewhere to the most eminent scientific and practical men, to ascertain by actual experiment what these conditions are! So complete was the ignorance of the powers of locomotion by steam which prevailed, even among engineers, previous to the opening of the Liverpool railway, that the transport of heavy goods was regarded as the chief object of the undertaking, and its principal source of revenue. The incredible speed of transport, effected even in the very first experiments in 1830, burst upon the public, and on the scientific world, with all the effect of a new and unlooked-for phenomenon. On the unfortunate occasion which deprived the British nation of Mr. Huskisson, the wounded body of that statesman was transported a distance of about fifteen miles in twenty-five minutes, being at the rate of thirty-six miles an hour. The revenue of the road arising

from passengers since its opening, has, contrary to all that was foreseen, been vastly greater than that which has been derived from merchandise. So great was the want of experience in the construction of engines, that the company was at first ignorant whether they should adopt large steam-engines fixed at different stations on the line, to pull the carriages from station to station, or travelling engines to drag the loads the entire distance. Having decided on the latter, they have, even to the present moment, labored under the disadvantage of the want of that knowledge which experience alone can give. The engines have been constantly varied in their weight and proportions, in their magnitude and form, as the experience of each successive month has indicated. As defects became manifest they were remedied; improvements suggested were adopted; and each year produced engines of such increased power and efficiency, that their predecessors were abandoned, not because they were worn out, but because they had been outstripped in the rapid march of improvement. Add to this, that only one species of travelling engine has been effectively tried; the capabilities of others remain still to be developed; and even that form of engine which has received the advantage of a course of experiments on so grand a scale to carry it toward perfection, is far short of this point, and still has defects, many of which, it is obvious, time and experience will remove.

If, then, the locomotive engine, subject thus to all the imperfections inseparable from a novel contrivance—with the restrictions on the free application of skill and capital, arising from the nature of the monopolies granted to railway companies—with the disadvantage of very limited experience, the great parent of practical improvement, having been submitted to experiments hitherto only on a limited scale, and confined almost to one form of machine; if, under such disadvantages, such effects have been produced as are now daily witnessed by the public, what may not be looked for from this extraordinary power when the enterprise of the country shall be more unfettered—when greater fields of experience are opened—when time, ingenuity, and capital, have removed or diminished existing imperfections, and have brought to light new and more powerful principles? This is not mere speculation on abstract possibilities, but refers to what is in actual progress. The points of greatest wealth and population—the centres of largest capital and most active industry throughout the country—will soon be connected by lines of railway; and various experiments are proposed, with more or less prospect of success, for the application of steam-engines on stone roads where the intercourse is not sufficient to render railways profitable.

The important commercial and political effects attending such increased facility and speed in the transport of persons and goods, are too obvious to require any very extended notice here. A part of the price (and in many cases a considerable part) of every article of necessity or luxury, consists of the cost of transporting it from the producer to the consumer; and consequently every abatement or saving in this cost must produce a corresponding reduction in the price of every article transported; that is to say, of everything which is necessary for the subsistence of the poor, or for the enjoyment of the rich—of every comfort, and of every luxury of life. The benefit of this will extend, not to the consumer only, but to the producer: by lowering the expense of transport of the produce, whether of the soil or of the loom, a less quantity of that produce will be spent in bringing the remainder to market, and consequently a greater surplus will reward the labor of the producer. The benefit of this will be felt even more by the agriculturist than by the manufacturer; because the proportional cost of transport of the produce of the soil is greater than that of manufactures. If two hundred quarters of corn be neces-

sary to raise four hundred, and one hundred more be required to bring the four hundred to market, then the net surplus will be one hundred. But if by the use of steam-carriages the same quantity can be brought to market with an expenditure of fifty quarters, then the net surplus will be increased from one hundred to one hundred and fifty quarters: and either the profit of the farmer, or the rent of the landlord, must be increased by the same amount.

But the agriculturist would not merely be benefited by an increased return from the soil already under cultivation. Any reduction in the cost of transporting the produce to market would call into cultivation tracts of inferior fertility, the returns from which would not at present repay the cost of cultivation and transport. Thus land would become productive which is now waste, and an effect would be produced equivalent to adding so much fertile soil to the present extent of the country. It is well known that land of a given degree of fertility will yield increased produce by the increased application of capital and labor. By a reduction in the cost of transport, a saving will be made which may enable the agriculturist to apply to tracts already under cultivation the capital thus saved, and thereby increase their actual production. Not only, therefore, would such an effect be attended with an increased extent of cultivated land, but also with an increased degree of cultivation in that which is already productive.

It has been said that in Great Britain there are above a million of horses engaged in various ways in the transport of passengers and goods, and that to support each horse requires as much land as would, upon an average, support eight men. If this quantity of animal power were displaced by steam-engines, and the means of transport drawn from the bowels of the earth, instead of being raised upon its surface, then, supposing the above calculation correct, as much land would become available for the support of human beings as would suffice for an additional population of eight millions; or, what amounts to the same, would increase the means of support of the present population by about one third of the present available means. The land which now supports horses for transport would then support men, or produce corn for food.

The objection that a quantity of land exists in the country capable of supporting horses alone, and that such land would be thrown out of cultivation, scarcely deserves notice here. The existence of any considerable quantity of such land is extremely doubtful. What is the soil which will feed a horse, and not feed oxen or sheep, or produce food for man? But even if it be admitted that there exists in the country a small portion of such land, that portion cannot exceed, nor indeed equal, what would be sufficient for the number of horses which must after all continue to be employed for the purposes of pleasure, and in a variety of cases where steam must necessarily be inapplicable. It is to be remembered, also, that the displacing of horses in one extensive occupation, by diminishing their price, must necessarily increase the demand for them in others.

The reduction in the cost of transport of manufactured articles, by lowering their price in the market, will stimulate their consumption. This observation applies of course not only to home but to foreign markets. In the latter, we already, in many branches of manufactures, command a monopoly. The reduced price which we shall attain by cheapness and facility to transport, will still further extend and increase our advantages. The necessary consequence will be, an increased demand for manufacturing population; and this increased population again reacting on the agricultural interests, will form an increased market for that species of produce. So interwoven and complicated are the fibres which form the texture of the highly-civilized and artificial community

in which we live, that an effect produced on any one point is instantly transmitted to the most remote and apparently unconnected parts of the system.

The two advantages of increased cheapness and speed, besides extending the amount of existing traffic, call into existence new objects of commercial intercourse. For the same reason that the reduced cost of transport, as we have shown, calls new soils into cultivation, it also calls into existence new markets for manufactured and agricultural produce. The great speed of transit which has been proved to be practicable, must open a commerce between distant points in various articles, the nature of which does not permit them to be preserved so as to be fit for use beyond a certain time. Such are, for example, many species of vegetable and animal food, which at present are confined to markets at a very limited distance from the grower or feeder. The truth of this observation is manifested by the effects which have followed the intercourse by steam on the Irish channel. The western towns of England have become markets for a prodigious quantity of Irish produce, which it had been previously impossible to export. If animal food be transported alive from the grower to the consumer, the distance of the market is limited by the power of the animal to travel, and the cost of its support on the road. It is only particular species of cattle which bear to be carried to market on common roads and by horse-carriages. But of the peculiar nature of a railway, the magnitude and weight of the loads which may be transported on it, and the prodigious speed which may be attained, render the transport of cattle, of every species, to almost any distance, both easy and cheap. In process of time, when the railway system becomes extended, the metropolis and populous towns will therefore become markets, not as at present to districts within limited distances of them, but to the whole country.

The moral and political consequences of so great a change in the powers of transition of persons and intelligence from place to place are not easily calculated. The concentration of mind and exertion which a great metropolis always exhibits, will be extended in a considerable degree to the whole realm. The same effect will be produced as if all distances were lessened in the proportion in which the speed and cheapness of transit are increased. Towns at present removed some stages from the metropolis, will become its suburbs; others, now at a day's journey, will be removed to its immediate vicinity; business will be carried on with as much ease between them and the metropolis, as it is now between distant points of the metropolis itself. Let those who discard speculations like these as wild and improbable, recur to the state of public opinion, at no very remote period, on the subject of steam navigation. Within the memory of persons who have not yet passed the meridian of life, the possibility of traversing by the steam-engine the channels and seas that surround and intersect these islands, was regarded as the dream of enthusiasts. Nautical men and men of science rejected such speculations with equal incredulity, and with little less than scorn for the understanding of those who could for a moment entertain them. Yet we have witnessed steam-engines traversing, not these channels and seas alone, but sweeping the face of the waters round every coast in Europe. The seas which interpose between the Asiatic dominions and Egypt, and those which separate the British shores from America, have offered an equally ineffectual barrier to its powers. If steam be not used as the only means of connecting the most distant points of our planet, it is not because it is inadequate to the accomplishment of that end, but because the supply of the material, from which at the present moment it derives its powers, is restricted by local and accidental circumstances.

I propose at present to lay before you some account of the means whereby the effects above referred to have been produced; of the manner and degree

in which the public have availed themselves of these means; and of the improvements of which they seem to us to be susceptible.

It is a singular fact, that in the history of this invention considerable time and great ingenuity were vainly expended in attempting to overcome a difficulty, which in the end turned out to be purely imaginary. To comprehend distinctly the manner in which a wheel-carriage is propelled by steam, suppose that a pin or handle is attached to the spoke of the wheel at some distance from its centre, and that a force is applied to this pin in such a manner as to make the wheel revolve. If the tire of the wheel and the surface of the road were absolutely smooth and free from friction, so that the face of the tire would slide without resistance upon the road, then the effect of the force thus applied would be merely to cause the wheel to turn round, the carriage being stationary, the surface of the tire slipping or sliding upon the road as the wheel is made to revolve. But if, on the other hand, the pressure of the face of the tire upon the road is such as to produce between them such a degree of adhesion as will render it impossible for the wheel to slide or slip upon the road by the force which is applied to it, the consequence will be, that the wheel can only turn round in obedience to the force which moves it by causing the carriage to advance, so that the wheel will roll upon the road, and the carriage will be moved forward, through a distance equal to the circumference of the wheel, each time it performs a complete revolution.

It is obvious that both of these effects may be partially produced; the adhesion of the wheel to the road may be insufficient to prevent slipping altogether, and yet it may be sufficient to prevent the wheel from slipping as fast as it revolves. Under such circumstances the carriage would advance and the wheel would slip. The progressive motion of the carriage during one complete revolution of the wheel would be equal to the difference between the complete circumference of the wheel and the portion through which in one revolution it has slipped.

When the construction of travelling steam-engines first engaged the attention of engineers, and for a considerable period afterward, a notion was impressed upon their minds that the adhesion between the face of the wheel and the surface of the road must necessarily be of very small amount, and that in every practical case the wheels thus driven would either slip altogether, and produce no advance of the carriage, or that a considerable portion of the impelling power would be lost by the partial slipping or sliding of the wheels. It is singular that it should never have occurred to the many ingenious persons who for several years were engaged in such experiments and speculations, to ascertain by experiment the actual amount of adhesion in any particular case between the wheels and the road. Had they done so, we should probably now have found locomotive engines in a more advanced state than that to which they have attained.

To remedy this imaginary difficulty, Messrs. Trevethick and Vivian proposed to make the external rims of the wheels rough and uneven, by surrounding them with projecting heads of nails or bolts, or by cutting transverse grooves on them. They proposed, in cases where considerable elevations were to be ascended, to cause claws or nails to project from the surface during the ascent, so as to take hold of the road.

In seven years after the construction of the first locomotive engine by these engineers, another locomotive engine was constructed by Mr. Blinkensop, of Middleton colliery, near Leeds. He obtained a patent, in 1811, for the application of a rack-rail. The railroad thus, instead of being composed of smooth bars of iron, presented a line of projecting teeth, like those of a cog-wheel, which stretched along the entire distance to be travelled. The wheels on

which the engine rolled were furnished with corresponding teeth, which worked in the teeth of the railroad, and, in this way, produced a progressive motion in the carriage.

The next contrivance for overcoming this fictitious difficulty, was that of Messrs. Chapinan, who, in the year 1812, obtained a patent for working a locomotive engine by a chain extending along the middle of the line of railroad, from the one end to the other. This chain was passed once round a grooved wheel under the centre of the carriage; so that, when this grooved wheel was turned by the engine, the chain being incapable of slipping upon it, the carriage was consequently advanced on the road. In order to prevent the strain from acting on the whole length of the chain, its links were made to fall upon upright forks placed at certain intervals, which between those intervals sustained the tension of the chain produced by the engine. Friction-rollers were used to press the chain into the groove of the wheel, so as to prevent it from slipping. This contrivance was soon abandoned, for the very obvious reason that a prodigious loss of force was incurred by the friction of the chain.

The following year, 1813, produced a contrivance of singular ingenuity, for overcoming the supposed difficulty arising from the want of adhesion between the wheels and the road. This was no other than a pair of mechanical legs and feet, which were made to walk and propel in a manner somewhat resembling the feet of an animal.

A sketch of these propellers is given in fig. 63. A is the carriage moving

Fig. 63.

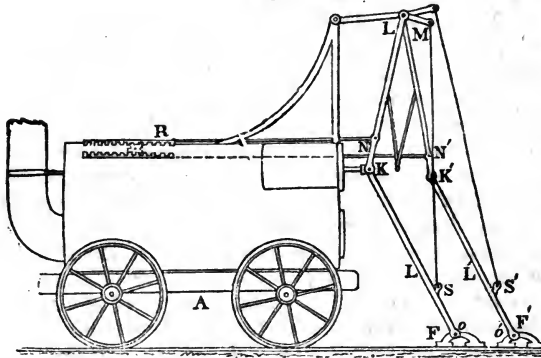

on the railroad, L and L' are the legs, F and F' the feet. The foot F has a joint at O, which corresponds to the ankle; another joint is placed at K, which corresponds to the knee; and a third is placed at L, which corresponds to the hip. Similar joints are placed at the corresponding letters in the other leg. The knee-joint K is attached to the end of the piston of the cylinder. When the piston, which is horizontal, is pressed outward, the leg L presses the foot F against the ground, and the resistance forces the carriage A onward. As the carriage proceeds, the angle K at the knee becomes larger, so that the leg and thigh take a straighter position; and this continues until the piston has reached the end of its stroke. At the hip L there is a short lever L M, the extremity of which is connected by a cord or chain with a point S, placed near the shin of the leg. When the piston is pressed into the cylinder, the knee K is drawn toward the engine, and the cord M S is made to lift the foot F from the ground; to which it does not return until the piston has arrived at the extremity of the cylinder. On the piston being again driven out

of the cylinder, the foot F, being placed on the road, is pressed backward by the force of the piston-rod at K; but the friction of the ground preventing its backward motion, the reaction causes the engine to advance: and in the same manner this process is continued.

Attached to the thigh at N, above the knee, by a joint, is a horizontal rod N R, which works a rack R. This rack has beneath it a cog-wheel. This cog-wheel acts in another rack below it. By these means, when the knee K is driven from the engine, the rack R is moved backward; but the cog-wheel acting on the other rack beneath it, will move the latter in the contrary direction. The rack R being then moved in the same direction with the knee K, it follows that the other rack will always be moved in a contrary direction. The lower rack is connected by another horizontal rod with the thigh of the leg L F', immediately above the knee at N'. When the piston is forced inward, the knee K' will thus be forced backward; and when the piston is forced outward, the knee K' will be drawn forward. It therefore follows, that the two knees K and K' are pressed alternately backward and forward. The foot F' when the knee K' is drawn forward, is lifted by the means already described for the foot F.

It will be apparent, from this description, that the piece of mechanism here exhibited is a contrivance derived from the motion of the legs of an animal, and resembling in all respects the fore legs of a horse. It is, however, to be regarded rather as a specimen of great ingenuity than as a contrivance of practical utility.

It was about this period that the important fact was first ascertained that the adhesion or friction of the wheels with the rails on which they moved was amply sufficient to propel the engine, even when dragging after it a load of great weight; and that in such case, the progressive motion would be effected without any slipping of the wheels. The consequence of this fact rendered totally useless all the contrivances for giving wheels a purchase on the road, such as racks, chains, feet, &c. The experiment by which this was determined, appears to have been first tried on the Wylam-railroad; where it was proved, that when the road was level, and the rails clean, the adhesion of the wheels was sufficient, in all kinds of weather, to propel considerable loads. By manual labor it was first ascertained how much weight the wheels of a common carriage would overcome without slipping round on the rail, and having found the proportion which that bore to the weight, they then ascertained that the weight of the engine would produce sufficient adhesion to drag after it on the railroad the requisite number of wagons.

In 1814 an engine was constructed at Killingworth, by Mr. Stephenson, having two cylinders with a cylindrical boiler, and working two pair of wheels, by cranks placed at right angles; so that when the one was in full operation, the other was at its dead points. By these means the propelling power was always in action. The cranks were maintained in this position by an endless chain, which passed around two cogged wheels placed under the engine, and which were fixed on the same axles on which the wheels were placed. The wheels in this case were fixed on the axles, and turned with them.

In an engine subsequently constructed by Mr. Stephenson, for the Killingworth railroad, the mode adopted of connecting the wheels by an endless chain and cog-wheels was abandoned; and the same effect was produced by connecting the two cranks by a straight rod. All such contrivances, however, have this great defect, that, if the fore and hind wheels be not constructed with dimensions accurately equal, there must necessarily be a slipping or dragging on the road. The nature of the machinery requires that each wheel should perform its revolution exactly in the same time; and consequently, in

doing so, must pass over exactly equal lengths of the road. If, therefore, the circumference of the wheels be not accurately equal, that wheel which has the lesser circumference must be dragged along so much of the road as that by which it falls short of the circumference of the greater wheel ; or, on the other hand, the greater wheel must be dragged in the opposite direction, to compensate for the same difference. As no mechanism can accomplish a perfect equality in four, much less in six wheels, it may be assumed that a great portion of that dragging effect is a necessary consequence of the principle of this machine ; and even were the wheels, in the first instance accurately constructed, it is not possible that their wear could be so exactly uniform as to continue equal.

The next stimulus which the progress of this invention received, proceeded from the great national work undertaken at Liverpool, by which that town and the extensive commercial mart of Manchester were connected by a double line of railway. When this project was undertaken, it was not decided what moving power it might be most expedient to adopt as a means of transport on the proposed road : the choice lay between horse-power, fixed steam-engines, and locomotive engines ; but the first, for many obvious reasons, was at once rejected in favor of one or other of the last two.

The steam-engine may be applied by two distinct methods to move wagons, either on a turnpike road, or on a railway. By the one method, the steam-engine is fixed, and draws the carriage, or train of carriages, toward it by a chain extending the whole length of the road on which the engine works. By this method, the line of road over which the transport is conducted, is divided into a number of short intervals, at the extremity of each of which an engine is placed. The wagons, or carriages, when drawn by any engine to its own station, are detached, and connected with the extremity of the chain worked by the next stationary engine ; and thus the journey is performed, from station to station, by separate engines. By the other method, the same engine draws the load the whole journey, travelling with it.

The directors of the Liverpool and Manchester railroad, when that work was advanced toward its completion, employed, in the spring of the year 1829, Messrs. Stephenson and Lock, and Messrs. Walker and Rastrick, experienced engineers, to visit the different railways, where practical information respecting the comparative effect of stationary and locomotive engines was likely to be obtained ; and from these gentlemen they received reports on the relative merits, according to their judgment, of the two methods. The particulars of their calculations are given at large in the valuable work of Mr. Nicholas Wood on railways ; to which we refer the reader, not only on this, but on many other subjects connected with the locomotive steam-engine, into which it would be foreign to our object to enter. The result of the comparison of the two systems was, that the capital necessary to be advanced to establish a line of stationary engines was considerably greater than that which was necessary to establish an equivalent power in locomotive engines ; that the annual expense by the stationary engines was likewise greater ; and that, consequently, the expense of transport by the latter was greater, in a like proportion.

The decision of the directors was, therefore, in favor of locomotive engines ; and their next measure was to devise some means by which the inventive genius of the country might be stimulated to supply them with the best possible form of engines for this purpose. With this view, it was proposed and carried into effect to offer a prize for the best locomotive engine which might be produced under certain proposed conditions, and to appoint a time for a public trial of the claims of the candidates. A premium of five hundred pounds was accordingly offered for the best locomotive engine to run on the Liverpool and

Manchester railway; under the condition that it should produce no smoke; that the pressure of the steam should be limited to fifty pounds on the inch; and that it should draw at least three times its own weight, at the rate of not less than ten miles an hour; that the engine should be supported on springs, and should not exceed fifteen feet in height. Precautions were also proposed against the consequences of the boiler bursting; and other matters not necessary to mention more particularly here. This proposal was announced in the spring of 1829, and the time of trial was appointed in the following October. The engines which underwent the trial were, the Rocket, constructed by Mr. Stephenson; the Sanspareil, by Hackworth; and the Novelty, by Messrs. Braithwaite and Ericsson. Of these, the Rocket obtained the premium. A line of railway was selected for the trial, on a level piece of road, about two miles in length, near a place called Rainhill, between Liverpool and Manchester: the distance between the two stations was a mile and a half, and the engine had to travel this distance backward and forward ten times, which made altogether a journey of thirty miles. The Rocket performed this journey twice: the first time in 2 hours 14 minutes and 8 seconds; and the second time in 2 hours 6 minutes and 49 seconds. Its speed at different parts of the journey varied: its greatest rate of motion was rather above 29 miles an hour; and its least, about $11\frac{1}{2}$ miles an hour. The average rate of the one journey was $13\frac{4}{10}$ miles an hour; and of the other, $14\frac{2}{10}$ miles. This was the only engine which performed the complete journey proposed, the others having been stopped from accidents which occurred to them in the experiment. The Sanspareil performed the distance between the stations eight times, travelling $22\frac{1}{2}$ miles in 1 hour 37 minutes and 16 seconds. The greatest velocity to which this engine attained was something less than 23 miles per hour. The Novelty had only passed twice between the stations when the joints of the boiler gave way, and put an end to the experiment.

The great object to be attained in the construction of these engines was, to combine with sufficient lightness the greatest possible heating power. The fire necessarily acts on the water in two ways: first, by its radiant heat; and second, by the current of heated air which is carried by the draught through the flues, and finally passes into the chimney. To accomplish this object, therefore, it is necessary to expose to both these sources of heat the greatest possible quantity of surface in contact with the water.

The superiority of the Rocket may be attributed chiefly to the greater quantity of surface of the water which was exposed to the action of the fire. With a less extent of grate-bars than the Sanspareil, in the proportion of three to five, it exposed a greater surface of water to radiant heat, in the proportion of four to three; and a greater surface of water to heated air, in the proportion of more than three to two. It was found that the Rocket, compared with the Sanspareil, consumed fuel, in the evaporation of a given quantity of water, in the proportion of eleven to twenty-eight.

The object to be effected in the boilers of these engines is, to keep a small quantity of water at an excessive temperature, by means of a small quantity of fuel kept in the most active state of combustion. To accomplish this, it is necessary, first, so to shape the boiler, furnace, and flues, that the water shall be in contact with as extensive a surface as possible, every part of which is acted on, either immediately, by the heat radiating from the fire, or mediately, by the air which has passed through the fire, and which finally rushes into the chimney: and, secondly, that such a forcible draught should be maintained in the furnace, that a quantity of heat shall be extracted from the fuel, by combustion, sufficient to maintain the water at the necessary temperature, and to produce the steam with sufficient rapidity. To accomplish these objects,

therefore, the chamber containing the grate should be completely surrounded by water, and should be below the level of the water in the boiler. The magnitude of the surface exposed to radiation should be as great as is consistent with the whole magnitude of the machine. In the next place, it is necessary that the heat, which is absorbed by the air passing through the fuel, and keeping it in a state of combustion, should be transferred to the water before the air escapes into the chimney. Air being a bad conductor of heat, to accomplish this, it is necessary that the air in the flues should be exposed to as great an extent of surface in contact with the water as possible. No contrivance can be less adapted for the attainment of this end than one or two large tubes traversing the boiler, as in the earliest locomotive engines: the body of air which passed through the centre of these tubes had no contact with their surface, and consequently passed into the chimney at nearly the same temperature as that which it had when it quitted the fire. The only portion of air which imparted its heat to the water was that portion which passed next to the surface of the tube.

Several methods suggest themselves to increase the surface of water in contact with a given quantity of air passing through it. This would be accomplished by causing the air to pass between plates placed near each other, so as to divide the current into thin strata, having between them strata of water, or it might be made to pass between tubes differing slightly in diameter, the water passing through an inner tube, and being also in contact with the external surface of the outer tube. Such a method would be similar in principle to the steam-jacket used in Watt's steam-engines, or to the condenser of Cartwright's engine. But, considering the facility of constructing small tubes, and of placing them in the boiler, that method perhaps is, on the whole, the best in practice; although the shape of a tube, geometrically considered, is most unfavorable for the exposure of a fluid contained in it to its surface. The air which passes from the fire-chamber, being subdivided as it passes through the boiler by a great number of very small tubes, may be made to impart all its excess of heat to the water before it issues into the chimney. This is all which the most refined contrivance can effect. The Rocket engine was traversed by twenty-five tubes, each three inches in diameter; and the principle has since been carried to a much greater extent.

The abstraction of a great quantity of heat from the air before it reaches the chimney is attended with one consequence, which, at first view, would present a difficulty apparently insurmountable; the chimney would, in fact, lose its power of draught. This difficulty, however, was removed by using the waste steam, which had passed from the cylinder after working the engine, for the purpose of producing a draught. This steam was urged through a jet presented upward in the chimney, and driven out with such force in that direction as to create a sufficient draught to work the furnace.

The importance of this subject will be understood, when it is considered that the only limit to the attainment of speed by locomotive engines is the power to produce, in a given time, a certain quantity of steam. Each stroke of the piston causes one revolution of the wheels, and consumes four cylinders full of steam; consequently, a cylinder of steam corresponds to a certain number of feet of road travelled over: hence it is that the production of a rapid and abundant supply of heat, and the imparting of that heat quickly and effectually to the water, is the key to the solution of the problem to construct an engine capable of rapid motion.

The method of subdividing the flue into tubes was carried much further by Mr. Stephenson after the construction of the Rocket; and, indeed, the principle was so obvious, it is only surprising that, in the first instance, tubes of

smaller diameter than three inches were not used. In engines since constructed, the number of tubes vary from ninety to one hundred and twenty, the diameter being reduced to two inches or less; and in some instances tubes have been introduced even to the number of one hundred and fifty, of one and a half inch diameter.

Since the period at which this railway was opened for the actual purposes of transport, the locomotive engines have been in a state of progressive improvement. Scarcely a month has passed without suggesting some change in the details, by which fuel might be economized, the production of steam rendered more rapid, the wear of the engine rendered slower, the proportionate strength of the different parts improved, or some other desirable end obtained.

Engines constructed in the form of the Rocket, were subject to two principal defects. The cylinders, being placed outside the engine, were exposed to the cold of the atmosphere, which produced a waste of heat more or less considerable by condensation. The point at which the power of the steam to turn the wheels was applied, being at the extremity of the axle and on the exterior of the wheel, a considerable strain was produced, owing to the distance of the point of application of the power from the centre of resistance. If it were possible that the impelling power could act in drawing the train at all times with equal energy to both sides of the engine, then no injurious strain would be produced; but from the relative position of the points on the opposite wheels to which it was necessary to attach the connecting rods, it was inevitable that, at the moment when one of the pistons exerts its full power in driving the wheel, the other piston must be altogether inactive. The impelling power, therefore, at alternate moments of time, acted on opposite wheels, and on each of them at the greatest possible distance from the centre of the axle.

The next step in the improvement of the machine was made with a view to remove these two defects. The cylinders were transferred from the exterior of the engine to the interior of the casing called the smoke-box, B, fig. 64.

Fig. 64.

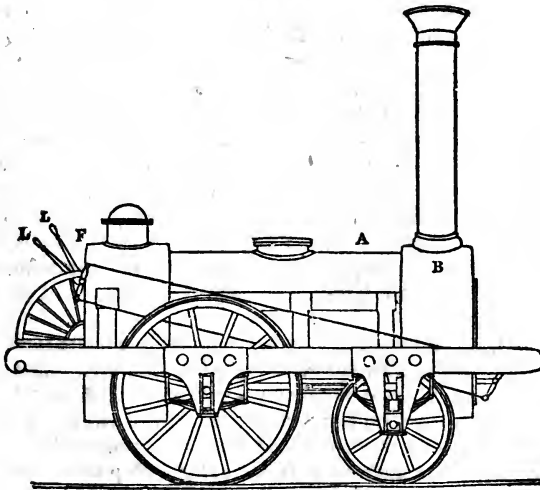

which supports the chimney, and which receives the heated air issuing from the tubes which traverse the boiler. Thus placed, the cylinders are always maintained as hot as the air which issues from the flues, and all condensation of steam by their exposure is prevented. The piston-rods are likewise brought

closer together, and nearer the centre of the engine: the connecting-rods, no longer attached to the wheels, are made to act upon two cranks constructed upon the axle of the wheels, and placed at right angles to each other. From the position of these cranks, one would always be at its dead points when the other is in full motion. The action of the steam upon them would, therefore, be generally unequal; but this would not produce the same strain as when the connecting-rods are attached to points upon the exterior of the wheels, owing to the cranks being constructed on the axle at points so much nearer its centre. By this means it was found that the working of the machine was more even, and productive of much less strain, than in the arrangement adopted in the Rocket, and the earlier engines. On the other hand, a serious disadvantage was incurred by a double-cranked axle. The weakness necessarily arising from such a form of axle could only be removed by great thickness and weight of metal; and even this precaution, at first, did not prevent their occasional fracture. The forging of them was, however, subsequently much improved: the cranks, instead of being formed by bending the metal when softened by heat, were formed by cutting the square of the crank out of the solid metal; and now it rarely happens that one of these axles fails.

The adoption of smaller tubes, and a greater number of them, with a view more perfectly to extract the heat from the air in passing to the chimney, rendered a more forcible draught necessary. This was accomplished by the adoption of a more contracted blast-pipe leading from the eduction-pipes of the cylinders, and presented up the chimney. A representation of such a blast-pipe, with the two tubes leading from the cylinders, and uniting together near the point, which is presented up the chimney, is given at *pp* in fig. 74. The engine thus improved is represented in fig. 64.

A represents the cylindrical boiler, the lower half of which is traversed by tubes. They are usually from eighty to one hundred in number, and about an inch and a half in diameter; the boiler is about seven feet in length; the fire-chamber is attached to one end of it, at *F*, the cylinders are inserted in a chamber at the other end, immediately under the chimney. The piston-rods are supported in the horizontal position by guides; and connecting-rods extend from them, under the engine, to the two cranks placed on the axle of the large wheels. The effects of an inequality in the road are counteracted by springs, on which the engine rests; the springs being below the axle of the great wheels, and above that of the less. The steam is applied to the cylinders, and withdrawn, by means of the common sliding valves, which are worked by an eccentric wheel placed on the axle of the large wheels of the carriage. The motion is communicated from this eccentric wheel to the valve by sliding rods. The stand is placed for the attendant at the end of the engine, next the fireplace *F*; and two levers *L* project from the end which communicate with the valves, by means of rods, by which the engine is governed so as to reverse the motion.

The wheels of these engines have been commonly constructed of wood with strong iron ties, furnished with flanges adapted to the rails. But Mr. Stephenson afterward substituted, in some instances, wheels of iron with hollow spokes. The engine draws after it a tender carriage containing the fuel and water; and, when carrying a light load, is capable of performing the whole journey from Liverpool to Manchester without a fresh supply of water. When a heavy load of merchandise is drawn, it is usual to take in water at the middle of the trip.

In reviewing all that has been stated, it will be perceived that the efficiency of the locomotive engines used on this railway, is mainly owing to three circumstances: 1st, the unlimited power of draught in the furnace, by projecting

the waste steam into the chimney; 2d, the almost unlimited abstraction of heat from the air passing from the furnace, by arrangement of tubes traversing the boiler; and, 3d, keeping the cylinders warm, by immersing them in the chamber under the chimney. There are many minor details which might be noticed with approbation, but these constitute the main features of the improvements.

The great original cost, and the heavy expense of keeping the engines used on the railway in repair, have pressed severely on the resources of the undertaking. One of the best-constructed of the later engines costs originally 1,500*l.*, and sometimes more. The original cost, however, is far from being the principal source of expense; the wear and tear of these machines, and the occasional fracture of those parts on which the greatest strain has been laid, have greatly exceeded what the directors had anticipated. Although this source of expense must be in part attributed to the engines not having yet attained that state of perfection, in the proportion and adjustment of their parts, of which they are susceptible, and to which experience alone can lead, yet there are some obvious defects which demand attention.

The heads of the boilers are flat, and formed of iron, similar to the material of the boilers themselves. The tubes which traverse the boiler were, until recently, copper, and so inserted into the flat head or end as to be water-tight. When the boiler was heated, the tubes were found to expand in a greater degree than the other parts of the boiler; which frequently caused them either to be loosened at the extremities, so as to cause leakage, or to bend from want of room for expansion. The necessity of removing and refastening the tubes caused, therefore, a constant expense.

The fireplace being situated at one end of the boiler, immediately below the mouths of the tubes, a powerful draught of air, passing through the fire, carries with it ashes and cinders, which are driven violently through the tubes, and especially the lower ones situated near the fuel. These tubes are, by this means, subject to rapid wear, the cinders continually acting upon their interior surface. After a short time it becomes necessary to replace single tubes, according as they are found to be worn, by new ones; and it not unfrequently happens, when this is neglected, that tubes burst. After a certain length of time the engines require new tubing. This wear of the tubes might possibly be avoided by constructing the fireplace in a lower position, so as to be more removed from their mouths; or, still more effectually, by interposing a casing of metal, which might be filled with water, between the fireplace and those tubes which are the most exposed to the cinders and ashes. The unequal expansion of the tubes and boilers appears to be an incurable defect, if the present form of the engine be retained. If the fireplace and chimney could be placed at the same end of the boiler, so that the tubes might be recurved, the unequal expansion would then produce no injurious effect; but it would be difficult to clean the tubes, if they were exposed, as they are at present to the cinders. The next source of expense arises from the wear of the boiler-heads, which are exposed to the action of the fire.

A considerable improvement was subsequently introduced into the method of tubing, by substituting brass for copper tubes. I am not aware that the cause of this improvement has been discovered; but it is certain, whatever be the cause, that brass tubes are subject to considerably slower wear than copper ones.

Since the date to which the preceding observations refer, the locomotive engine has undergone several improvements in detail of considerable importance; among which, the addition of a third pair of wheels deserves to be particularly mentioned. An engine supported on three pairs of wheels has great security in the event of the fracture of any one of the axles—the remain-

ing axles and wheels being sufficient for the support of the machine. Connected with this change is another, recommended by Mr. Robert Stephenson, by which the flanges are removed from the driving wheels, those upon the remaining pairs of wheels being sufficient to keep the engine in its position upon the rails. We shall now describe a locomotive engine similar in construction to those almost universally used at present on railroads, as well in this as in other countries.

In fig. 67 is exhibited a vertical section of the engine made by a plane carried through its length; and in fig. 68, is exhibited a corresponding section of its tender—the tender being supposed to be joined on to the engine at the part where the connecting points appear to be broken in the drawing. In fig. 69, is exhibited the plan of the working machinery, including the cylinders, pistons, eccentrics, &c., which are under the boiler, by the operation of which the engine is driven. Fig. 70, represents the tender, also taken in the plan.

In fig. 71, is represented an elevation of the hinder end of the engine next the fire-box; and in fig. 72, is represented a cross vertical section through the fire-box, and at right angles to the length of the engine, showing the interior of the boiler above and beside the fire-box, the rivets and bolts connecting the internal and external fire-boxes, the regulator, steam funnel, and steam dome.

In fig. 73, is represented an elevation of the front of the engine next the smoke-box, showing the cylinder covers W, buffers T, &c.; and in fig. 74, is represented a section of the interior of the smoke-box, made by a vertical plane at right angles to the engine, showing the tube-plate forming the foremost end of the boiler, the branches S of the steam-pipe leading to the cylinders, the blast-pipe *p*, the cylinders H, and the chimney G.

The same letters of reference are placed at corresponding parts in the different figures.

The boiler, as has been explained in the engines already described, is a cylinder placed upon its side, the section of which is exhibited at A, fig. 67. The fire-box consists of two casings of metal, one within the other. The fire-grate is represented at D. The tubes by which the products of combustion are drawn from the fire-box to the smoke-box F are represented at E. Upon the smoke-box is erected the chimney G. In the engine from which this drawing has been taken, and which was used on the London and Birmingham railway, the boiler is a cylinder, $7\frac{1}{2}$ feet long, and $3\frac{1}{2}$ feet in diameter. It is formed out of wrought-iron plates $\frac{5}{16}$ of an inch in thickness, overlapping each other, and bound together by iron rivets $\frac{7}{8}$ of an inch in diameter and $1\frac{3}{4}$ inch apart. One of these rivets, as it joins two plates, is represented in fig. 65. The boiler is clothed with a boarding of wood *a*, an inch in thickness, and bound round by iron hoops screwed together at the bottom. Wood being a slow conductor of heat, this covering has the effect of keeping the boiler warm, and checking the condensation of steam which would otherwise be produced by the rapid motion of the engine through the cold air.

The external fire-box, B B. is a casing nearly square in its plan, being four feet wide outside, and three feet seven and a half inches long, measured in the direction of the boiler. It is constructed of wrought-iron plates, similar to those of the boiler. This box descends about two feet below the boiler, the top being semi-cylindrical, as seen in fig. 72, of a somewhat greater diameter than the boiler, and concentric with it. The front of the fire-box next the end of the boiler has a circular opening equal in size to the end of the boiler. To the edge of this opening the boiler is fastened by angle irons, and rivets in the manner represented in fig. 66. These rivets are seen in section in fig. 67.

LONGITUDINAL VERTICAL SECTION OF A LOCOMOTIVE ENGINE.

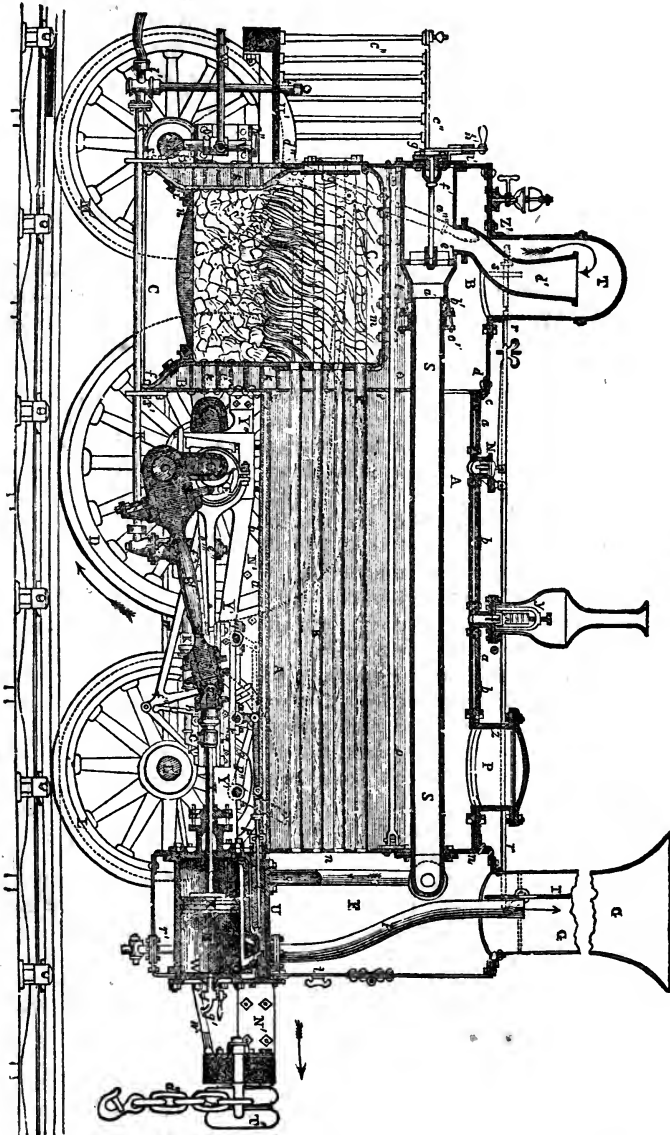
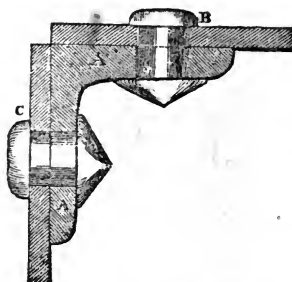

Fig. 67.

Fig. 65.



Fig. 66.



The internal fire-box C, fig. 67, is similar in shape to the external, only it is flat at the top, and close everywhere except at the bottom. Between it and the external fire-box an open space of three inches and a half is left all round, and on the side next the boiler this space is increased to four inches. This internal fire-box is made of copper plates, $\frac{7}{16}$ of an inch in thickness, everywhere except next the boiler, where the thickness is $\frac{7}{8}$.

As the sides and front of the external fire-box, and all the surfaces bounding the internal fire-box, are flat, their form is unfavorable for the resistance of pressure. Adequate means are, therefore, provided for strengthening them. The plates forming the internal fire-box are bent outward near the bottom, until they are brought into contact with those of the external fire-box, to which they are attached by copper rivets, as represented at *f*, in fig. 67. The plates forming the bounding surfaces of the two fire-boxes are fastened together by stays represented at *k*, in figs. 67 and 72. These stays which are of copper, have a screw cut upon them through their whole length, and holes are made through the plates of both fire-boxes tapped with corresponding threads. The copper screws are then passed through them, and rivets formed on their heads within and without, as seen in fig. 72. These screw rivets connect all parts of the plating of the two fire-boxes which are opposed to each other: they are placed at about four inches apart over the sides and back of the internal fireplace and that part of the front which is below the boiler.

As the top of the internal fire-box cannot be strengthened by stays of this kind, ribs of wrought iron, which are seen in their length at *l*, in fig. 67, and of which an end view is seen in fig. 72, are attached by bolts to it. These ribs are hollowed out, as seen in fig. 67, between bolt and bolt, in order to break their contact with the roof of the fire-box, and allow a more free passage to the heat through it. If they were in continuous contact with the fire-box, the metal composing them would become more highly heated, and would soon wear out, besides intercepting heat from the water. This part of the fire-box is subject to rapid wear, unless care be taken that the level of the water be preserved at its proper height in the boiler. Even when the boiler is properly filled, the depth of water above the roof of the fire-box is not considerable, and on the least neglect the roof may be exposed to the contact of steam, in which case it will soon be destroyed.

To prevent accidents arising from this cause, a leaden plug represented at *m*, figs. 67 and 72, is inserted in the roof of the internal fire-box. If the water be allowed to subside, this plug will melt out before the copper is very injuriously heated, and the steam rushing out at the aperture will cause the fire to be extinguished.

Copper fire-boxes are almost universally used; but sometimes, from the consideration of cheapness, the internal fire-box is constructed of iron.

Fig. 68.

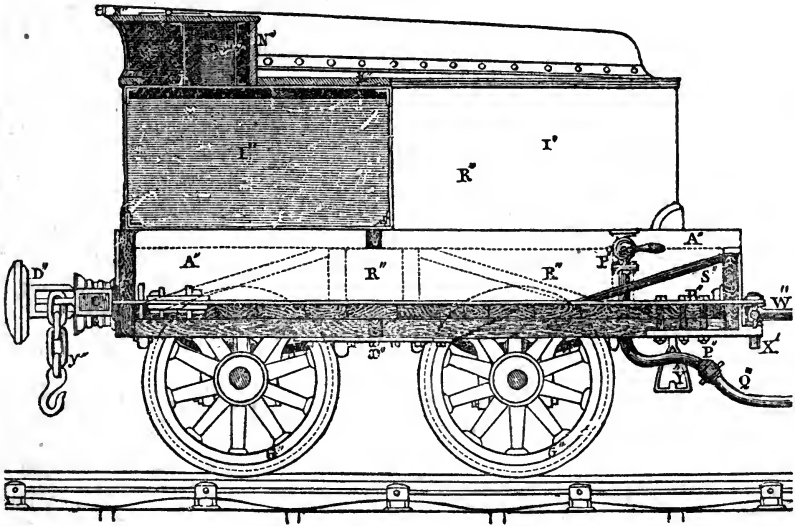

LONGITUDINAL VERTICAL SECTION OF THE TENDER.

Fig. 70.

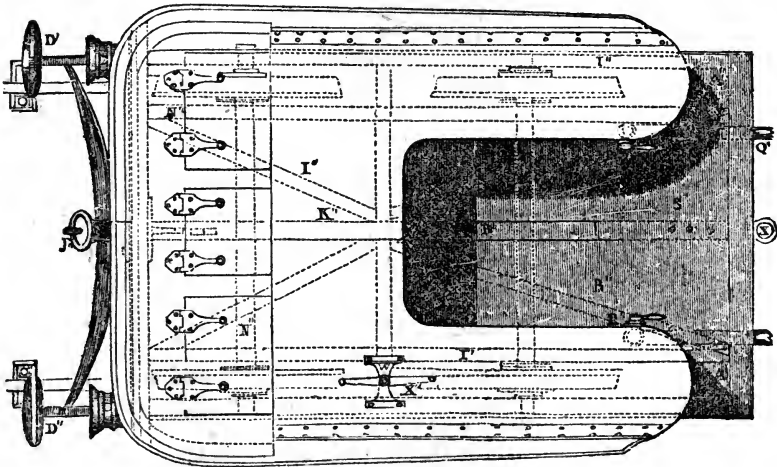

PLAN OF THE TENDER.

In the plating which forms the back of the external fire-box, an oval aperture is formed, as represented in the back view of the engine, fig. 71, for the fire-door *g*. The plating of the internal fire-box around this aperture, is bent at right angles, to meet that of the external fire-box, to which it is fastened by a row of copper rivets. The fire-door is formed of two plates of wrought iron, riveted together, with a space of nine inches and a half between them. The air between these plates being an imperfect conductor of heat, keeps the outer plate of the fire door at a moderate temperature.

In that part of the surface of the internal fire-box which forms the end of the boiler, holes are made to receive the extremities of the tubes, by which the air proceeding from the fire is drawn to the smoke-box at the remote end of the boiler. These tubes are represented in longitudinal section at *E*, fig. 67, and their ends are seen in the surface of the internal fire-box in fig. 72, and in the remote end of the boiler, where they terminate in the smoke-box in fig. 74. These tubes are formed of the best rolled brass, and their thickness in the engine to which we now refer, is $\frac{1}{3}$ of an inch. After the brass plating is bent into the form of a tube, and being overlapped, is properly soldered together, and the edges smoothed off, the tubes are made perfectly cylindrical by being drawn through a circular steel die.

The tube-plates (as those parts of the boiler ends in which the tubes are inserted are called) are bored with holes in corresponding positions, truly cylindrical, and corresponding in magnitude to the tubes, so that the tubes, when passed into them, will be just in contact with them. The length of the tubes is so regulated, that when extending from end to end of the boiler, and passing through the holes, they shall project at each end a little beyond the holes. The manner of fastening them so as to be water-tight is as follows: A steel hoop or ferrule, made slightly conical, a section of which is exhibited at *C*, fig. 75, the smaller end of which is a little less than the internal diameter of

Fig. 75.

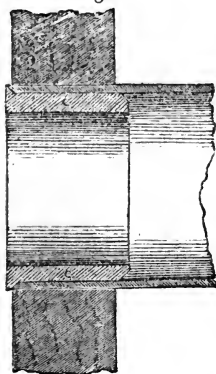

the tube, but which increases toward the outer end, is driven in as represented in the figure. It acts as a wedge, and forces the tube into close contact with the edges of the hole in the tube plate.

When particular tubes in a boiler are worn out, and require to be replaced, their removal is easily effected. It is only necessary to cut the steel ferrule on the inside, and to bend it off from contact with the tube, by which means it can be loosened and withdrawn, and the tube removed.

In the engine to which this description refers there were one hundred and twenty-four tubes, the external diameter of which was $1\frac{5}{8}$ inch. The distance

between tube and tube was $\frac{1}{4}$ of an inch. The number of tubes vary in different engines, some having so many as one hundred and fifty, while the number in some is less than ninety. The evaporating power of an engine greatly depends on the proper number and magnitude of its tubes; and the experience which engineers have had on railways have led them gradually to increase the number of tubes, and diminish their magnitude. In the Rocket, already mentioned as having gained the prize on the opening of the Liverpool and Manchester railway, the number of tubes was twenty-four, and their diameter three inches; but in all the engines subsequently made their number was augmented, and their diameter diminished. The practical inconvenience which limits the size of the tubes is their liability to become choked by cinders and ashes, which get wedged in them when they are too small, and thereby obstruct the draught, and diminish the evaporating power of the boiler. The tubes now in use, of about an inch and a half internal diameter, not only require to be cleared of the ashes and cinders, which get fastened in them after each journey, but it is necessary throughout a journey of any length that the tubes should be picked and cleaned by opening the fire-door at convenient intervals.

When tubes fail, they are usually destroyed by the pressure of the water crushing them inward: the water enters through the rent made in the tube, and flowing upon the fire extinguishes it. When a single tube thus fails upon a journey, the engine, notwithstanding the accident, may generally be made to work to the end of its journey by plugging the ends of the broken tube with hard wood; the water in contact with which will prevent the fire from burning it away.

The tubes act as stays, connecting the ends of the boiler to strengthen them. Besides these, there are rods of wrought iron extended from end to end of the boiler above the roof of the internal fireplace. These rods are represented at *o* in their length in fig. 67, and an end view of them is seen in fig. 72. The smoke-box *F*, figs. 67, 74, containing the cylinders, steam-pipe, and blast-pipe, is four feet wide, and two feet long. It is formed of wrought iron plates, half an inch thick on the side next the boiler, and a quarter of an inch elsewhere. The plates are riveted in the same manner as those of the fire-box already described. From the top of the smoke-box, which, like the fire-box, is semi-cylindrical, as seen in elevation in fig. 73, and in section in fig. 74, rises the chimney *G*, fifteen inches diameter, and formed of $\frac{1}{8}$ inch iron plates, riveted and bound round by hoops. It is flanged to the top of the smoke-box, as represented in fig. 74. Near the bottom of the smoke-box the working cylinders are placed, side by side, in a horizontal position, with the slide valves upward. In the top of the external fire-box a circular aperture is formed fifteen inches in diameter, and upon this aperture is placed the steam-dome *T* figs. 67, 71, 72, two feet high, and attached around the circular aperture by a flange and screw secured by nuts. This steam dome is made of brass $\frac{3}{8}$ inch thick. In stationary boilers, where magnitude is not limited, it has been already explained, that the space allowed for steam is sufficiently large to secure the complete separation of the vapor from the spray which is mixed with it when it issues immediately from the water. In locomotive boilers sufficient space cannot be allowed for this, and the separation of the water from the steam is effected by the arrangement here represented. A funnel-shaped tube *d'*, figs. 67, 72, with its wide end upward, rises into the steam-dome, and reaches nearly to the top of it. This funnel bends toward the back of the fire-box, and is attached by a flange and screws to the great steam-pipe *S*, which traverses the whole length of the boiler. The steam rising from the boiler fills the steam-dome *T*, and descends in the funnel-shaped tube *d'*. The space it has thus to traverse enables the steam to disengage itself almost

completely from the priming. The wider part of the great steam-pipe a is flanged and screwed at the hinder end to a corresponding aperture in the back plate of the fire-box. This opening is covered by a circular plate, secured by screws, having a stuffing-box in its centre, of the same kind as is used for the piston-rods of steam-cylinders. Through this stuffing-box the spindle a'' of the regulator passes, and to its end is attached a winch h' , by which the spindle a'' is capable of being turned. This winch is limited in its play to a quarter of a revolution. The other end of the spindle a'' is attached to a plate e' , seen edgewise in fig. 67, and the face of which is seen in fig. 72; this circular plate e' is perforated with two apertures somewhat less than quadrants. That part of the plate, therefore, which remains not pierced forms two solid pieces somewhat greater than quadrants. This plate is ground so as to move in steam-tight contact with a fixed plate under it, which terminates at the wide end of the conical mouth of the steam-pipe S . This fixed circular plate is likewise pierced with two nearly quadrantal apertures, corresponding with those in the moveable plate e' . When the moveable plate e' is turned round by the winch h' , the apertures in it may be made to correspond with those of the fixed circular plate on which it moves, in which position the steam-pipe S communicates with the funnel d' by the two quadrantal apertures thus open. If, on the other hand, the winch h' be moved from this position through a quarter revolution, then the quadrantal openings in the moveable plate will be brought over the solid parts of the fixed plate on which it moves, and these solid parts being a little more than quadrants, while the openings are a little less, all communication between the steam-pipe S and the funnel d' will be stopped, for in this case the quadrantal openings in the fixed and moveable plates respectively will be stopped by the solid parts of these plates. It will be evident that as the winch h' of the regulator is moved from the former position to the latter, in every intermediate position the aperture communicating between the funnel d' and the steam-pipe S will be less in magnitude than the complete quadrant. It will in fact be composed of two openings having the form of *sectors* of a circle less than a quadrant, and these sectors may be made of any magnitude, however small, until the opening is altogether closed.

By such means the admission of steam from the boiler to the steam-pipe S may be regulated by the winch h' .

The steam being admitted to the steam-pipe passes through it to the front end of the boiler, and the pipe being enclosed within the boiler the temperature of the steam is maintained. The steam-pipe passing through the tube-plate at the front end of the boiler is carried to a small distance from the tube-plate in the same direction, where it is flanged on to a cross horizontal pipe proceeding to the right and to the left as represented in fig. 74. This cross pipe is itself flanged to two curved steam-pipes, S , fig. 74, by which the steam is conducted to the valve-boxes $V V$. The lower ends of these curved arms are flanged on to the valve-boxes of the two cylinders at the ends nearest to the boiler. The opening of one of these is exhibited in the right-hand cylinder in fig. 69. By these pipes the steam is conducted into the valve-boxes or steam-chests, from which it is admitted by slide-valves to the cylinders to work the pistons in the same manner as has been already described in the large stationary engines.

On the upper sides of the cylinders are formed the steam-chests or valve-boxes, which are exhibited at U , figs. 67, 69, 74. These are made of cast-iron half an inch thick, and are bolted to the upper side of each cylinder. At the front end they are also secured by bolts to the smoke-box, and at the hinder end are attached to the tube-plate. These valve-boxes communicate

PLAN OF THE WORKING MACHINERY OF A LOCOMOTIVE ENGINE.

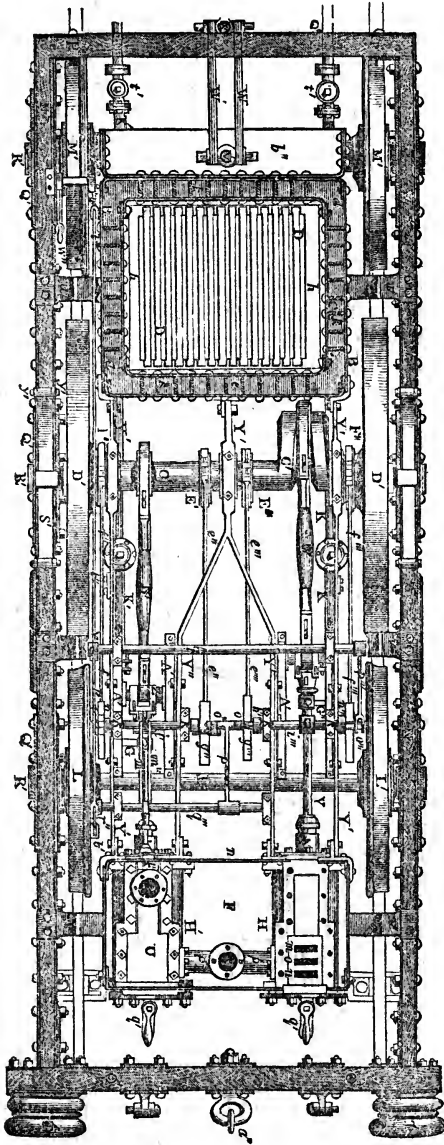
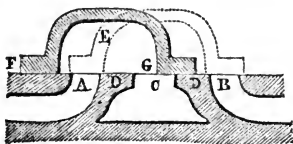

Fig. 69.

with the passages *m* and *n*, fig. 69, leading to the top and bottom of the cylinder: these are called the steam-ports. They also communicate with a passage *o* leading to the mouth of a curved horizontal pipe *p'* connecting the front ends of the two cylinders, as seen in figs. 69, 74. These curved pipes unite in a single vertical pipe *p*, called the *blast-pipe*, seen in figs. 67, 74, this vertical pipe becomes gradually small toward the top, and terminates a little above the base of the funnel or chimney *G*. In the valve-box is placed the slide-valve *v* to which is attached the spindle *v'*. This spindle moves through a stuffing-box *h'*, and is worked by gearing, which will be described hereafter. According to the position given to the slide, a communication may be opened between the steam-chest, or the waste-port, and either end of the cylinders. Thus when the slide is in the position represented in fig. 67, the steam-chest communicates with the front end of the cylinder, while the waste-port communicates with the hinder end. If, on the other hand, the spindle *v'* being pressed forward, move the slide to its extreme opposite position, the steam-port *n* would communicate with the waste-port *o*, while the steam-chest would communicate with the steam-port *m*, steam would, therefore, be admitted to the hinder end of the cylinder, while the foremost end would communicate with the waste-port. It will be perceived that this arrangement is precisely similar to that of the slide-valves already described. The slide-valve is represented on a larger scale in fig. 76, where *A* is the hinder steam-port, *B* the foremost steam-

Fig. 76.



port, and *C* the waste-port. The surfaces *D*, separating the steam-ports from the waste-ports, are called the bars: they are planed perfectly smooth, so that the surfaces *F* and *G* of the slide-valve, also planed perfectly smooth, may move in steam-tight contact with them. These surfaces are kept in contact by the pressure of the steam in the steam-chest, by which the slide-valve is always pressed down. In its middle position, as represented by the dotted lines in the figure, both the steam-ports are stopped by the slide-valve, so that at that moment no steam is admitted to either end of the cylinder. On either side of this intermediate position the slide has an inch and a half play, which is sufficient to open successively the two steam-ports.

The cylinders are inserted at one end in the plate of the smoke-box, and at the other in the tube-plate of the boiler. They are closed at either end by cast-iron covers, nearly an inch thick, flanged on by bolts and screws. In the cover of the cylinder attached to the tube-plate is a stuffing-box, in which the piston-rod plays. The metallic pistons used in locomotive engines do not differ materially from those already described, and therefore need not be here particularly noticed. From their horizontal position they have a tendency to wear unequally in the cylinders, their weight pressing them on one side only; but from their small magnitude this effect is found to be imperceptible in practice. In the engine here described the stroke of the piston is eighteen inches, and this is the most usual length of stroke in locomotive engines. The piston, in its play, comes at either end within about half an inch of the inner surface of the covers of the cylinders, this space being allowed to prevent collision. In the foremost cover of the cylinder is inserted a cock *q'*, figs. 67, 69, by

Fig. 71.

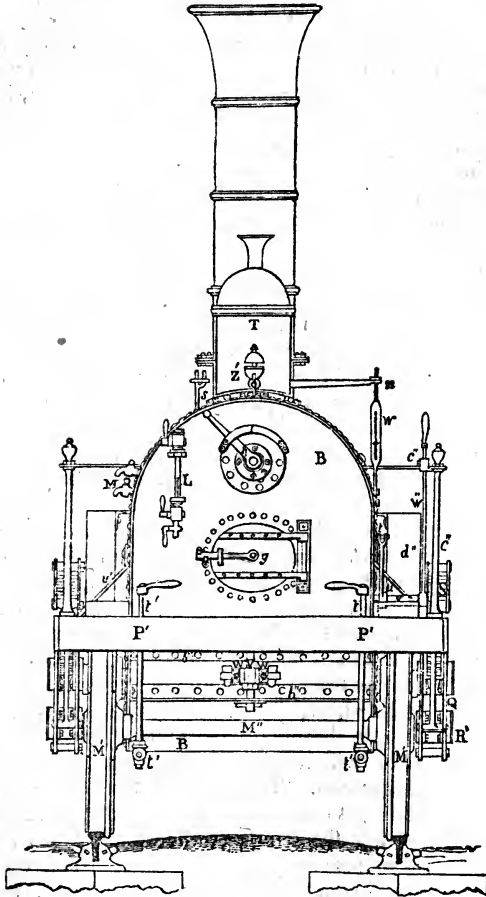

ELEVATION OF THE HINDER END OF A LOCOMOTIVE ENGINE.

which any water which may collect in the cylinder by condensation or priming may be discharged. A cock *r*, fig. 67, communicating with a small tube proceeding from the branches of the waste pipe *p*, fig. 74, is likewise provided to discharge from that pipe any water which may be collected in it. After the steam has been admitted to work the piston through the slide-valve, and has been discharged through the waste-port by shifting that valve, it passes through the pipe *p* into the blast-pipe *p*, from the mouth of which it issues, with great force, up the funnel *G*. When the motion of the engine is rapid, the steam from the two cylinders proceeds in an almost uninterrupted current from the blast-pipe, and causes a strong draught up the chimney. The heated air which passes from the mouths of the tubes into the smoke-box is drawn up by this current, and a corresponding draught is produced in the fire-box.

The piston-rods *Y* terminate in a fork, by which they are attached to cross heads *Z*, the ends of which are confined by guide-bars *A'*, in which they are allowed to play backward and forward through a space equal to the stroke of the piston. To these cross heads *Z*, between the prongs of the fork in which the piston terminates, are attached the foremost ends of the connecting rods *B'*. These rods are, therefore, driven backward and forward by the motion imparted to the cross head *Z* by the piston-rods *Y*. The connecting rods *B'* are attached at the hinder ends to two cranks formed upon the axles *C'* of the driving wheels *D'*. These two cranks are formed upon the axles precisely at right angles to each other. The left-hand crank is represented in its horizontal position, in fig. 69, and the right-hand crank is seen in its vertical position. A cranked axle is represented on a larger scale in fig. 77, and the two cranks are seen in a position oblique to the plane of the figure.

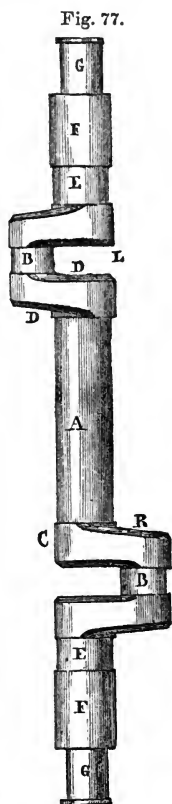

As this axle is the instrument by which the impelling force is conveyed to the load, and as it has to support a great portion of the weight of the engine, it is constructed with great strength and precision. It is made all in one piece, and of the best wrought iron called back barrow, or scrap iron. In the engine here described its extreme length is six feet and a half, and its diameter is five inches. At the centre part *A* it is cylindrical, and is increased to five inches and a quarter at *C*, where the cranks are formed. The sides *D* of the cranks are four inches thick, and the crank pins *B*, which are truly cylindrical, are five inches diameter, and three inches in length, the brasses at the extremities of the connecting rods which play upon them having a corresponding magnitude. The distance from the centre of the crank-pins *B* to the centre of the axle *A* must be exactly equal to half the stroke of the piston, and is, therefore, in this case precisely nine inches. Upon the parts *F*, which are seven inches and a half long, the great driving wheels are firmly fastened, so as to be prevented from turning or shaking upon the axle. The axle projects beyond the wheels at *G*, where it is reduced to three inches and an eighth diameter. These projecting parts *G* are five inches long, having collars at the outer ends. Brasses are fixed at the outside frame of the engine which rest upon these projections *G* of the axle, and upon these brasses the weight of the engine is supported. The entire axle is accurately turned in a lathe, and each

of the crank-pins B is likewise turned by suspending the axle on centres corresponding with the centres of the crank-pins, and made on strong cast iron arms, which are firmly fixed on the ends of the axle, and project beyond the cranks so as to balance the axle, and enable it to turn round on the centre of the crank-pin. The axle is by such means made perfectly true, and the cranks are made of exactly the proper length, and precisely at right angles to each other. The corners of the cranks are chamfered off, as shown in the figure, and the ends of the cylindrical parts well rounded out.

The strength and accuracy of construction indispensable in these cranked axles, in order to make them execute their work, render them very expensive. When properly constructed, however, they are seldom broken, but are sometimes bent when the engine escapes from the rails.

The proper motion to admit and withdraw the steam from either end of the cylinder is imparted to the slide-valves by eccentrics, in a manner and on a principle so similar to that already described in large stationary engines, that it will not be necessary here to enter into any detailed explanation of the apparatus for communicating this motion, which is exhibited in plan and section in figs. 67, 69. The eccentrics are attached to the cranked axles at E' E'' . The eccentric E' imparts motion by a rod e'' to a lever h'' , formed on an axle extending across the frame of the engine. This conveys motion to another lever l'' , projecting from the same axle. This lever l'' is jointed to horizontal links m'' , which at the foremost ends are attached to the spindle l' , by which the slide is driven. By these means the motion received by the eccentric from the great working axle conveys to the spindle l' an alternate movement backward and forward, and the points at which it is reversed will be regulated by the position given to the eccentric upon the great axle. The eccentric is formed in two separate semicircles, and is keyed on to the great axle, and consequently any position may be given to it which may be required. The position to be given to the eccentrics should be such that they shall be at right angles to their respective cranks, and they should be fixed a quarter of a revolution behind the cranks so as to move the slides to that extent in advance of the piston, since by the position of the levers h'' and l'' , the motion of the eccentric becomes reversed before it reaches the valve spindle.

The performance of the engine is materially affected by the position of the eccentrics on the working axle. The slide should begin to uncover the steam-port a little before the commencement of the stroke of the piston, in order that the steam impelling the piston should be shut off, and the steam about to impel it in the contrary direction admitted before the termination of the stroke. Through this small space the steam, therefore, must act in opposition to the motion of the piston. This is called the *lead* of the slide, and the extent generally given to it is about a quarter of an inch. This is accomplished by fixing the eccentrics not precisely at right angles to the respective cranks, but a little in advance of that position. The introduction of the steam to the piston before the termination of the stroke has the effect of bringing it gradually to rest at the end of the stroke, and thereby diminishing the jerk or shock produced by the rapid change of motion. In stationary engines, where the reciprocations of the engine are slow, the necessity for this provision does not arise; but in locomotive engines in which the motion of the piston is changed from four to six times in a second, it becomes necessary. The steam admitted to the piston before the termination of the stroke acts as a spring-cushion to assist in changing its motion, and if it were not applied, the piston could not be kept tight upon the piston-rod. Another advantage which is produced by allowing some lead to the slide is that the waste steam which has just impelled the piston begins to make its escape through the waste-port before the com-

mencement of the next stroke, so that when the impelling steam begins to produce the returning stroke, there is less waste steam on the other side of the piston to resist it.

When the motion of the engine is very rapid, the resistance of the waste steam, as it escapes from the blast-pipe to the piston, has been generally supposed to be very considerable, though we are not aware of any direct experiments by which its amount has been ascertained. In the account of the locomotive engine which has been here described, supplied by Mr. Stephenson for the last edition of Tredgold on the steam-engine, he states, that the average resisting pressure of the waste steam throughout the stroke is 6 lbs. per square inch, when running at the usual rate of from 25 to 28 miles an hour, and that at greater velocities this negative pressure has been found to increase to more than double that amount. No experiments are, however, cited from which this inference has been drawn.

It has been also thought that the pressure of steam upon the piston in the cylinder, at high velocities, is considerably below the pressure of steam in the boiler; but this has not been, so far as we are informed, ascertained by any satisfactory experimental test. Mr. Stephenson likewise states, that this loss of pressure, causes the negative pressure or resistance of the waste steam to amount to from 30 to 40 per cent. of the positive pressure upon the piston when the engine is running very fast, and that therefore the power of the engine is diminished nearly one half.

But it will be perceived that besides the uncertainty which attends the estimate of the actual amount of pressure on the piston compared with the pressure of steam in the boiler, the inference here drawn does not appear to be compatible with what has been already proved respecting the mechanical effect of steam. No change of pressure which may take place between the boiler and the cylinder can affect the practical efficacy of the steam. As the steam passes through the engine, whatever change of pressure it may be subject to, it still remains common steam: and though its pressure may be diminished, its volume being increased in a nearly equal proportion, its mechanical effect will remain the same. The power of the engine, therefore, estimated as it ought to be, by the whole mechanical effect produced, will not be altered otherwise than by the effect of the increased resistance produced by the blast-pipe. What that resistance is, we repeat, has not, so far as we know, been ascertained by direct experiment, and there are circumstances attending it which render it probable that, even at high velocities, it is less in amount than Mr. Stephenson's estimate.

The position of the eccentrics which is necessary to make the pistons drive the engine forward must be directly the reverse of that which would cause them to drive the engine backward. To be able, therefore, to reverse the motion of the engine, it would only be necessary to be able to reverse the position of the eccentrics, which may be accomplished by either of two expedients.

First, The eccentrics may be capable of revolving on the great working axle, and also of sliding upon it through a small space. Their revolution on the axle may be checked by letting a pin attached to a collar fastened on the axle fall into a hole on the side of the eccentric. Such a pin will drive the eccentric round with the axle, and the position of this pin and the hole will determine the position of the eccentric with reference to the crank. At a short distance on the other side of the eccentric may be a corresponding collar with a pin in the opposite position. By moving the eccentric longitudinally on the axle, the former pin may be withdrawn from the hole, and the latter allowed to fall into the hole on the other side. Proper mechanism may be provided

Fig. 74.

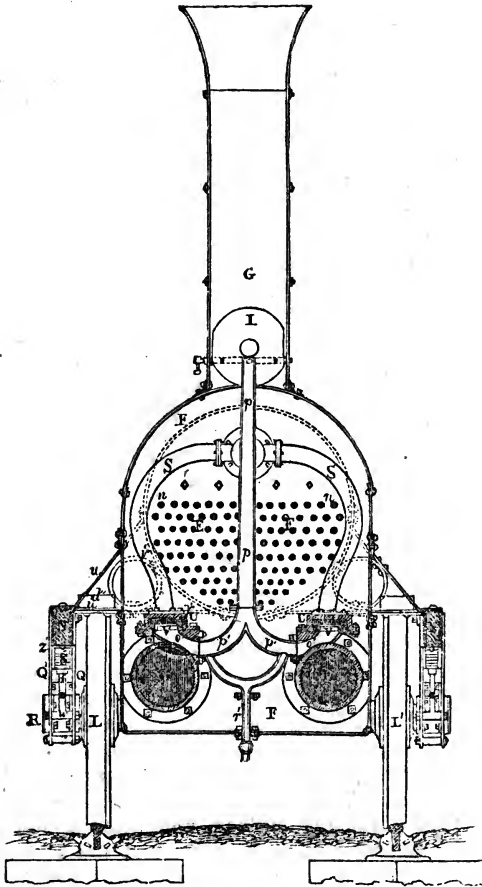

CROSS VERTICAL SECTION OF THE ENGINE THROUGH THE SMOKE-BOX.

by which the position of the eccentric may thus be reversed in reference to the crank, and by such means the motion of the engine may be reversed.

Secondly, Supposing the eccentrics which drive the engine forward to be immovably fixed upon the axle, two other eccentrics may be provided attached to other parts of the same axle, and having a position exactly the reverse with reference to the cranks. Proper mechanism may be provided, by which either or both pairs of eccentrics may be thrown in or out of gear. Such are the means adopted in the engine which has been already described. The eccentrics for driving the engine backward are placed outside the cranks at F' F'' . A hand lever w'' , fig. 71, is provided, by which the engine-man may throw either pair of eccentrics into or out of gear, so as to make the engine work either backward or forward.

As all the moving parts of the engine require to be constantly lubricated with oil to diminish the friction, and keep them cool, oil-cups for this purpose are fixed upon them. In some engines these oil-cups are attached separately to all the moving parts: in others they are placed near each other in a row on the boiler, and communicate by small tubes with the several parts required to be lubricated. One of these is requisite for each end of the connecting rods, for each of the guides of the piston-rods, for the piston-rod itself, the spindle of the slide-valve, and other parts. An elevation of one of these oil-cups is shown in fig. 78, a vertical section in fig. 79, and horizontal plan in fig. 80.

Fig. 78.



Fig. 79.



Fig. 80.

The cup A is made of brass with a cover B. This cover has a piece projecting from it turning upon a pin in a socket C at the side of the cup A, and square at the end, resting upon a small spring at the bottom of the socket to hold it either open or shut. In the bottom of the cup is inserted an iron tube D extending nearly to the top. This tube projects from the bottom of the cup, where it is tapped for the purpose of fixing the cup on the part of the engine which it is intended to lubricate. The hole into which the cup is screwed communicates with the rubbing surface, and some cotton thread is passed through the tube dipping into the oil in the cup at the one end and touching the moving part at the other. This thread acts as a siphon, and constantly drops oil on the rubbing surface.

The tender is a carriage attached behind the engine and close to it, carrying coke for the supply of the furnace, and water for the boiler. The coke is contained in the space R'' , figs. 68, 70, surrounded by a tank I'' containing water to feed the boiler. The feed for the boiler is conducted from the tank through a pipe descending downward and in a curved direction, P'' Q'' , fig. 68, and connected with a horizontal pipe K, fig. 67. A cock is provided at P'' , by which the supply of water to this pipe may be cut off at pleasure. Another cock is provided at t' , fig. 67, where the curved pipe joins the horizontal pipe by which the quantity of water supplied to K may be regulated by opening

the cock more or less fully. The handle of this cock rises through the floor of the engine, so that the engineer may regulate it at discretion. The pipe K being conducted under the engine, as represented in fig. 67, terminates in a vertical pipe, of greater diameter, containing two valves, both of which open upward, and between these valves to this vertical pipe is attached a force-pump, by which the water is drawn from the horizontal pipe K into the vertical pipe K', and from the latter is driven into a delivery-pipe by which it is forced into the boiler. The details of the interior of this feed-pump are represented on a larger scale in fig. 81. The extremity of the horizontal pipe

Fig. 81.

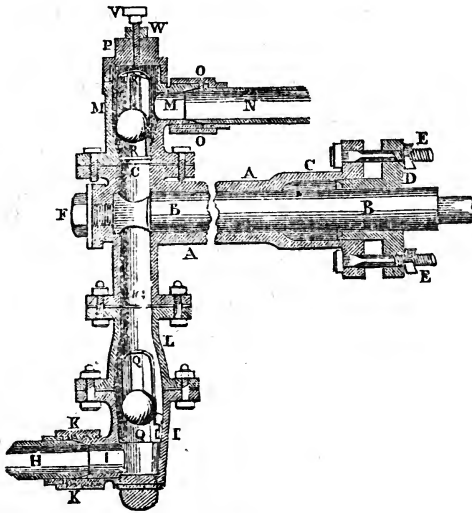

K' is represented in section at H, where it is joined on by a screw to the bottom of the vertical pipe which is represented in fig. 67, at K, and which is here represented in section. The vertical pipe, represented in fig. 67, consists of several parts screwed together by nuts and bolts passing through flanges. The lowest piece I is attached by a flange to the piece L: within these is contained the valve Q resting in a seat made conical, so that the ball which forms the valve shall rest in water-tight contact with it. The ball is turned and ground to an accurate sphere, and whatever position it assumes upon its seat its contact will be perfect. It is guided in its upward and downward motion by several vertical bars which confine it, and which are united at the top, so as to limit the upward motion of the ball. A screw V' is inserted in the bottom of the piece I, by removing which access can be obtained to the valve. The piece L is secured to the short pipe G by nuts and bolts passed through a flange. The pipe G is cast upon the end of the feed-pump A. On the foremost end of this feed-pump is constructed a stuffing-box C of the usual form, having a gland D forced against packing by nuts and screws E. The plunger B is turned so as to be truly cylindrical, and moves in water-tight contact through the gland D. The plunger not being in contact with the inner surface of the pump-barrel A, the latter need not be ground. The horizontal rod by which the plunger B is driven is attached at its foremost extremity to an arm which projects from the rod of the steam-piston, and consequently this plunger is moved through a space equal to the stroke of the steam-piston. In

this case that space is eighteen inches. The upper end of the vertical tube G is attached by screws and a flange to a piece P containing a valve R similar in all respects to the lower valve Q, and like it opening upward. A screw V is introduced at the top by which access may be obtained to this valve. This screw also presses on the crown of the guides of the valve, so as to hold it down by regulated pressure. At the side of this upper piece P is inserted a horizontal tube M connected with the end of the delivery-pipe N. This latter is continued to the boiler with which it communicates at the fire-box. When the plunger B is drawn out of the pump-barrel A, the spherical valve Q being relieved from its downward pressure is raised, and water passes from the pipe H through the valve Q into the vertical pipe G; the lower valve Q then closes and stops the return of the water. The plunger B returning into the pump-barrel A then forces the water against the upper valve R and drives it through the delivery-tube N, from which its return is prevented by the valve R. When the delivery-tube N is filled with water throughout its whole length, every stroke of the plunger will evidently drive into the boiler a volume of water equal to the magnitude of a part of the plunger eighteen inches in length.

Until within the last few years, locomotive engines were supported on only four wheels; they are, however, now almost universally supported on six, the driving wheels being in the middle. To give greater security to the position of the engine between the rails it is usual to construct flanges on the tires of all the six wheels. Mr. Stephenson, however, has been in the practice of constructing the driving wheels without flanges, and with tires truly cylindrical, depending on the flanges of the two pairs of smaller wheels to maintain the engine between the rails. The wheels of the engine here described are constructed in this manner. The driving wheels D' are fixed on the cranked axle C', and are five feet in diameter. The other wheels L' M', the one being placed immediately behind the smoke-box, and the other immediately behind the fire-box, are each three feet six inches in diameter, and have a flange upon their tires, which running on the inside of each rail keeps the engine between the rails. Each pair of these small wheels, like the driving-wheels, is fixed upon their axle. The axles are $3\frac{5}{8}$ inches diameter, and project beyond the wheels, the projecting part supporting the frame of the engine and turning in brasses. Upon these brasses rest springs, which bear the whole weight of the engine. These springs having nothing between them and the road but the wheels and axles intercept and equalize the sudden shocks produced by the rapid motion upon the road.

When an engine is required for the transport of very heavy loads, such as those of merchandise, the adhesion of one pair of working wheels is found to be insufficient, and, in such cases, one of the two pairs of wheels L' M' is made of the same diameter as the wheels which are placed upon the working axle, and a bar is attached to points on the outside of the wheels at equal distances from their centre, connecting them in such a manner that any force applied to make one pair of wheels revolve must necessarily impart the same motion to the other pair. By such means the force of the steam is made to drive both pairs of wheels and consequently a proportionally-increased adhesion is obtained.

The velocity which an engine is capable of imparting to the load which it draws depends upon the rate at which the pistons are capable of being moved in the cylinders. By every motion of each piston backward and forward one revolution of the driving wheels is produced, and by each revolution of the driving wheels, supposing them not to slip upon the rails, the load is driven through a distance upon the road equal to their circumference. As the two

cylinders work together, it follows, that a quantity of steam sufficient to fill four cylinders supplied by the boiler to the engine will move the train through a distance equal to the circumference of the driving wheels; and in accomplishing this, each piston must move twice from end to end of the cylinder; each cylinder must be twice filled with steam from the boiler; and that steam must be twice discharged from the cylinder through the blast-pipe into the chimney.

If the driving-wheels be five feet in diameter, their circumference will be fifteen feet seven inches. To drive a train with a velocity of thirty miles an hour, it will be necessary that the engine should be propelled through a space of forty-five feet per second. To accomplish this with five-foot wheels, they must be therefore made to revolve at the rate of very nearly three revolutions per second; and as each revolution requires two motions of the piston in the cylinder, it follows that each piston must move three times forward and three times backward in the cylinder in a second; that steam must be admitted six times per second from the steam-chest to each cylinder, and discharged six times per second from each cylinder into the blast-pipe. The motion, therefore, of each piston, supposing it to be uniform, must divide a second into six equal parts, and the puffs of the blast-pipe in the chimney must divide a second into twelve equal parts. The motion of the slides and other reciprocating parts of the machinery must consequently correspond.

This motion of the reciprocating parts of the machinery being found to be injurious to it, and to produce very rapid wear, attempts have been made to remedy the defect, and to obtain greater speed with an equal or diminished rate of motion of the piston, by the adoption of driving-wheels of greater diameter, and on several of the great lines of railway the magnitude of the wheels for the passenger-engines have been increased to five feet and a half and six feet in diameter; but such engines have not been sufficiently long in use to afford grounds for forming a practical estimate of their effects. Experiments of a much bolder description have, however, been tried on one of the great lines of railway by the adoption of driving-wheels of much greater diameter. In some cases their magnitude has been increased even to ten feet; but from various experiments to which these engines have been submitted by myself and others, as well as from the experience which appears to be obtained from the results of their ordinary work, it does not appear that any advantages have attended them, and they have been accordingly for the most part abandoned.

The pressure of steam in the boiler is limited by two safety-valves, represented in fig. 67, at N and O. The valve at N is under the control of the engineer, but the valve at O is inaccessible to him. The structure of the safety-valve represented at N is exhibited on a larger scale in fig. 82, which represents its section, and fig. 83, which shows a plan of the valve-seat with the

Fig. 82.

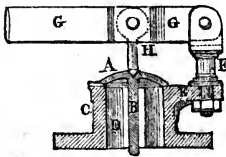
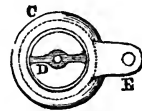

Fig. 83.



valve removed. The valve A, which is made of brass, is mitted round the edge at an angle of forty-five degrees, and has a spindle, or stalk B, cast upon it, projecting downward from the middle of it. The valve-seat C is also made

of brass, and cast with a flange at the bottom to attach it to the boiler. The mitred surface of the valve is ground into the valve-seat, so as to rest in steam-tight contact with it. Across the valve-seat, which is two and a half inches in diameter, is cast a thin piece D, seen in plan in fig. 83, and in section in fig. 82, which extends from the top to the bottom, and has a longitudinal hole through it, in which the spindle B of the valve works: by this hole it is guided when it rises from its seat. A projection E is cast upon the seat of the valve, in which a standard F is inserted. This standard is forked at the top, and receives the end of a lever G, which turns in it upon a centre. A rod H is jointed to this lever by another pin at three inches from the former, and the lower end of this rod, ground to a point, presses upon the centre of the valve A. At the other end of the lever, which is broken off in fig. 82, at a distance of three feet from the centre pin, inserted in the fork of the pillar F, the rod of a common spring-balance *w*, fig. 71, is attached by a finger-nut *n*. The bottom of this spring-balance is secured on to the fire-box. This balance is screwed up by the finger-nut on the valve-lever until the required pressure on the lever is produced through the medium of the rod H, this pressure being generally fifty pounds per square inch above the atmosphere. When the pressure of the steam in the boiler exceeds this, the valve A is raised from its seat, and the steam escapes.

It is evident that the sliding-weight by which the pressure of the safety-valve is sometimes regulated in stationary engines would not be admissible in a locomotive-engine, since the motion of the engine would constantly jolt it up and down, and cause the steam to escape. One of the disadvantages attending the use of the spring-valve is, that it can not be opened to let the steam escape without increasing its force, so that the steam, when escaping, must really have a greater pressure than that to which the valve has been previously adjusted. The longer the lever is, the greater will be this difference of pressure, inasmuch as a given elevation of the pin governing the rod H would cause a proportionally greater motion in that end of the lever attached to the spring.

The second safety-valve O is enclosed in a case, so that it is inaccessible, and its purpose is to limit the power of the engineer to increase the pressure of steam in the boiler. This valve is similar in construction to the former, but instead of being held down by a lever, is pressed upon by several small elliptical springs placed one above another over the valve, and held down by a screw which turns in a frame Y, fixed into the valve-seat. By this screw the pressure on the valve can be adjusted to any required degree; and if the open safety-valve be screwed down to a greater pressure, the steam will begin to escape from this second valve.

Also in the case where the boiler produces surplus steam faster than its escape can be effected at the valve N, the pressure will sometimes be increased until the valve O is opened, and its escape will take place from both valves.

The whole weight of the engine bears upon those parts of the six axles R', fig. 69, which project beyond the wheels. Boxes are formed in which these parts of the axles turn, and through the medium of which the weight of the engine rests upon them. Over these boxes are constructed oil or grease cups, by means of which the axles are constantly lubricated. It is usual to lubricate the axles of the engine itself with oil: the axles of the tender, and other coaches and wagons, are lubricated with a mixture of oil and tallow. In the middle of the box in which the axle turns, and between the two oil-cups, is cast a socket, in which the end of the spindle on which the spring presses rests. The springs are composed of a number of steel plates, laid, in the usual manner, one above the other, increasing in length upward. In the engine here described, the

plates, forming the springs of the driving-wheels are thirteen in number, each of which is four inches in width, and $\frac{5}{16}$ ths of an inch in thickness. The springs upon the other wheels are three inches in width. The springs of the driving-wheels are below the axle, while those of the smaller wheels are above it.

Buffers D'' are placed behind the tender, which act upon a spring C, fig. 70, to break the collision, when the wagons or carriages strike upon the tender, and similar buffers are attached to all passenger-coaches. Some of these buffers are constructed with a system of springs similar to C, but more elastic, and combined in greater number under the framing of the carriage, so that a considerable play is allowed to them. In some cases the rods of the buffers are made to act upon strong spiral springs inserted in the sides of the framing of the carriage. This arrangement gives greater play to the buffers; and as every coach in a train has several buffers, the combined effect of these is such, that a considerable shock, given to either end of the train, may be rendered harmless by being spent upon the elasticity of these several systems of springs.

In order to give notice of the approach of a train, a steam-whistle Z', figs. 67, 71, is placed immediately above the fire-box at the back of the engine. This is an apparatus composed of two small hemispheres of brass, separated one from the other by a small space. Steam is made to pass through a hollow space constructed in the lower hemisphere, and escapes from a very narrow circular opening round the edge of that hemisphere, rushing up with a force proportional to its pressure. The edge of the upper hemisphere presented downward encounters this steam, and an effect is produced similar to the action of air in organ-pipes. A shrill whistle is produced, which can be heard at a very considerable distance, and, differing from all ordinary sounds, it never fails to give timely notice of the approach of a train.

The water-tank I'', figs. 68, 70, which is constructed on the tender, is formed of wrought-iron plates $\frac{1}{4}$ of an inch thick, riveted at the corners by angle-iron already described. This tank is 9 feet long, $3\frac{3}{4}$ feet wide, and $2\frac{1}{4}$ feet deep. The top is covered with a board K'', and a raised platform N'' is constructed behind, divided into three parts, covered with leads, which open on hinges. The middle lid covers an opening to the tank by which water is let in: the lids at either side cover boxes in which are contained the tools necessary to be carried with the engine. The curved pipe P'', fig. 68, leading from the bottom of the tank to the pipe Q'' is of copper. The pipe Q'', connecting the latter with the feed-pipe K', fig. 69, is sometimes formed of leather or India-rubber cloth, having a spiral spring on the inside to prevent it from collapsing. It is necessary that this pipe Q'' should have a power of yielding to a sufficient degree to accommodate itself to the inequalities of motion between the engine and tender. A metal pipe is sometimes used, supplied with a double ball and socket, and a telescopic joint, having sufficient play to allow for the lateral and longitudinal inequalities of motion of the engine and tender. The weight of an engine, such as that here described, supplied with its proper quantity of water and fuel, is about 12 tons: the tender, when empty, weighs about $3\frac{1}{4}$ tons; and when filled with water and fuel, its weight is 7 tons. The tank contains 700 gallons of water, and the tender is capable of carrying about 800 weight of coke. This supply is sufficient for a trip of from thirty to forty miles with an ordinary load.

It is not usual to express the power of locomotive-engines in the same manner as that of other engines by the term horse-power. Indeed, until the actual amount of resistance opposed to these machines, under the various circumstances in which they are worked, shall be ascertained with some degree of

precision, it is impossible that their power or efficiency can be estimated with any tolerable degree of approximation. The quantity of water evaporated, and passed in steam through the cylinders, supplies a major limit to the power exerted; but even this necessary element for the calculation of the efficacy of these machines has not been ascertained by a sufficiently extensive course of observation and experiment. Mr. Stephenson states that the engine which has been here described is capable of evaporating 77 cubic feet of water per hour, while the early locomotive could only evaporate 16 cubic feet per hour. This evaporation, however, is inferior to that which I have ascertained myself to be produced by engines in regular operation on some of the northern railways. In an experiment made in July, 1839, with the Hecla engine, I found that the evaporation in a trip of ninety-five miles, from Liverpool to Birmingham, was at the rate of 93.2 cubic feet per hour, and in returning the same distance it was at the rate of 85.7 cubic feet per hour, giving a mean of 89 cubic feet per hour nearly. The Hecla weighed 12 tons; and its dimensions and proportions corresponded very nearly with those of the engine above described.

In a course of experiments which I made upon the engines then in use on the Grand Junction railway in the autumn of 1838, I found that the ordinary evaporating power of these engines varied from eighty to eighty-five cubic feet per hour.

Engines of much greater dimensions, and consequently of greater evaporating power, are used on the Great Western railway. In the autumn of 1838, experiments were made upon these engines by Mr. Nicholas Wood and myself, when we found that the most powerful engine on that line, the North Star, drawing a load of $110\frac{1}{2}$ tons gross, engine and tender inclusive, at $30\frac{1}{2}$ miles an hour, evaporated 200 cubic feet of water per hour. The same engine drawing a load of $194\frac{1}{2}$ tons at $18\frac{1}{2}$ miles an hour, evaporated 141 cubic feet per hour, and when drawing 45 tons at $38\frac{1}{2}$ miles an hour, evaporated 198 cubic feet of water per hour.

It has been already shown that a cubic foot of water evaporated per hour produces a gross amount of mechanical force very little less than two horse power, and consequently the gross amount of mechanical power evolved in these cases by the evaporation of the locomotive boilers will be very nearly twice as many horse-power as there are cubic feet of water evaporated per hour. Thus the evaporation of the Hecla, in the experiments made in July, 1839, gave a gross power of about one hundred and eighty horses, while the evaporation of the North Star gave a power of about four hundred horses. In stationary engines about half the gross power evolved in the evaporation is allowed for waste, friction, and other sources of resistance not connected with the load. What quantity should be allowed for this in locomotive engines is not yet ascertained, and therefore it is impossible to state what proportion of the whole evaporation is to be taken as representing the useful horse-power.

The great uniformity of resistance produced by the traction of carriages upon a railway is such as to render the application of steam-power to that purpose extremely advantageous. So far as this resistance depends on mechanical defects, it is probably rendered as uniform as is practicable, and in proportion to the quantity of load carried is reduced to as small an amount as it is likely to attain under any practicable circumstances. Until a recent period this resistance was ascribed altogether, or nearly so, to mechanical causes. The inequality of the road-surface, the friction of the axles of the wheels in their bearings, and the various sources of resistance due to the machinery of the engine, being the principal of these resistances, were for the most part in-

dependent of the speed with which the train was moved; and it was accordingly assumed in all calculations respecting the power of locomotive-engines that the resistance would be practically the same, whatever might be the speed of the train. It had been well understood that, so far as the atmosphere might offer resistance to the moving power, this would be dependent on the speed, and would increase in a very high ratio with the speed; but it was considered that the part of the resistance due to this cause formed a fraction of the whole amount so insignificant that it might be fairly disregarded in practice, or considered as a part of the actual computed resistance taken at an average speed.

It has been until a late period, accordingly assumed that the total amount of resistance to railway-trains which the locomotive engines have had to overcome was about the two hundred and fiftieth part of the gross weight of the load drawn: some engineers estimated it at a two hundred and twentieth; others at a two hundred and fiftieth; others at a three hundred and thirtieth part of the load; and the two hundred and fiftieth part of the gross load drawn may perhaps be considered as a mean between these much-varying estimates. What the experiments were, if any, on which these rough estimates were based, has never appeared. Each engineer formed his own valuation of this effect, but none produced the experimental grounds of their opinion. It has been said that the trains run down the engine, or that the drawing-chains connecting the engine slacken in descending an inclination of sixteen feet in a mile, or $\frac{1}{330}$. Numerous experiments, however, made by myself, as well as the constant experience now daily obtained on railways, show that this is a fallacious opinion, except at velocities so low as are never practised on railways.

In the autumn of 1838 a course of experiments was commenced at the suggestion of some of the proprietors of the Great Western railway company, with a view to determine various points connected with the structure and the working of railways. A part of these experiments were intended to determine the mean amount of the resisting force opposed to the moving power, and this part was conducted by me. After having tried various expedients for determining the mean amount of resistance to the moving power, I found that no method gave satisfactory results except one founded on observing the motion of trains by gravity down steep inclined planes. When a train of wagons or coaches is placed upon an inclined plane so steep that it shall descend by its gravity without any moving power, its motion when it proceeds from a state of rest, will be gradually accelerated, and if the resistance to that motion was, as it has been commonly supposed to be, uniform and independent of the speed, the descent would be uniformly accelerated; in other words, the increase of speed would be proportional to the time of the motion. Whatever velocity the train would gain in the first minute, it would acquire twice that velocity at the end of the second minute, three times that velocity at the end of the third minute, and so on; and this increase of velocity would continue to follow the same law, however extended the plane might be. That such would be the law which the descending motion of a train would follow had always been supposed, up to the time of the experiments now referred to; and it was even maintained by some that such a law was in strict conformity with experiments made upon railways and duly reported. The first experiments instituted by me at the time just referred to afforded a complete refutation of this doctrine. It was found that the acceleration was not uniform, but that with every increase of speed the acceleration was lessened. Thus if a certain speed were gained by a train in one second when moving at five miles an hour, a much less speed was gained in one second when moving ten miles an hour, and a

comparatively small speed was gained in the same time when moving at fifteen miles an hour, and so on. In fact, the augmentation of the rate of acceleration appeared to diminish in a very rapid proportion as the speed increased: this suggested to me the probability that a sufficiently great increase of speed would destroy all acceleration, and that the train would at length move at a uniform velocity. In effect, since the moving power which impels a train down an inclined plane of uniform inclination is that fraction of the gross weight of the train which acts in the direction of the plane, this moving power must be necessarily invariable; and as any acceleration which is produced must arise from the excess of this moving power over the resistance opposed to the motion of the train, from whatever causes that resistance may arise, whenever acceleration ceases, the moving force must necessarily be equal to the resistance; and therefore, when a train descends an inclined plane with a uniform velocity, the gross resistance to the motion of the train must be equal to the gross weight of the train resolved in the direction of the plane; or, in other words, it must be equal to that fraction of the whole weight of the train which is expressed by the inclination of the plane. Thus if it be supposed that the plane falls at the rate of one foot in one hundred, then the force impelling the train downward will be equal to the hundredth part of the weight of the train. So long as the resistance to the motion of the train continues to be less than the hundredth part of its weight, so long will the motion of the train be accelerated; and the more the hundredth part of the weight exceeds the resistance, the more rapid will the acceleration be; and the less the hundredth part of the weight exceeds the resistance, the less rapid will the acceleration be. If it be true that the amount of resistance increases with the increase of speed, then a speed may at length be attained so great that the amount of resistance to the motion of the train will be equal to the hundredth part of the weight. When that happens, the moving power of a hundredth part of the weight of the train being exactly equal to the resistance to the motion, there is no excess of power to produce acceleration, and therefore the motion of the train will be uniform.

Founded on these principles, a vast number of experiments were made on planes of different inclinations, and with loads of various magnitudes; and it was found, in general, that when a train descended an inclined plane, the rate of acceleration gradually diminished, and at length became uniform; that the uniform speed thus attained depended on the weight, form, and magnitude of the train, and the inclination of the plane; that the same train on different inclined planes attained different uniform speeds—on the steeper planes a greater speed being attained. From such experiments it followed, contrary to all that had been previously supposed, that the amount of resistance to railway-trains had a dependence on the speed; that this dependence was of great practical importance, the resistance being subject to very considerable variation at different speeds, and that this source of resistance arises from the atmosphere which the train encounters. This was rendered obvious by the different amount of resistance to the motion of a train of coaches and to that of a train of low wagons of equal weight.

The series of experiments which have established these general conclusions have not yet been sufficiently extended and varied to supply a correct practical estimate of the limit which it would be most advantageous to impose upon the gradients of railways; but it is certain that railways may be laid down, without practical disadvantage, with gradients considerably steeper than those to which it has been hitherto the practice to recommend as a limit.

The principle of compensation by varied speed being admitted, it will follow

that the time of transit between terminus and terminus of a line of railway laid down with gradients, varying from twenty to thirty feet a mile, will be practically the same as it would be on a line of the same length constructed upon a dead level; and not only will the time of transport be equal, but the quantity of moving power expended will not be materially different. The difference between the circumstances of the transport in the two cases will be merely that, on the undulating line, a varying velocity will be imparted to the train and a varying resistance opposed to the moved power; while on the level line the train would be moved at a uniform speed, and the engine worked against a uniform resistance. These conclusions have been abundantly confirmed by the experiments made in last July with the Hecla engine above referred to. The line of railway between Liverpool and Birmingham on which the experiment was made extended over a distance of ninety-five miles, and the gradients on which the effects were observed varied from a level to thirty feet per mile, a great portion of the line being a dead level. The following table shows the uniform speed with which the train ascended and descended the several gradients, and also the mean of the ascent and descent in each case, as well as the speed upon the level parts of the line:—

Gradient.	Speed.		Mean.
	Ascending.	Descending.	
<i>One in</i>	<i>Miles per hour.</i>	<i>Miles per hour.</i>	
177	22.25	41.32	31.78
265	24.87	39.13	32.00
330	25.26	37.07	31.16
400	26.87	36.75	31.81
532	27.35	34.30	30.82
590	27.37	33.16	30.21
650	29.03	32.58	30.80
Level	-	-	30.93

From this table it is apparent that the gradients do possess the compensating power with respect to speed already mentioned. The discrepancies existing among the mean values of the speed are only what may be fairly ascribed to casual variations in the moving power. The experiment was made under favorable circumstances: little disturbance was produced from the atmosphere; the day was quite calm. In the same experiment it was found that the water evaporated varied very nearly in proportion to the varying resistance, and the amount of that evaporation may be taken as affording an approximation to the mean amount of resistance. Taking the trip to and from Birmingham, over the distance of 190 miles, the mean evaporation per mile was 3.36 cubic feet of water. The volume of steam produced by this quantity of water will be determined approximately by calculating the number of revolutions of the driving-wheels necessary to move the engine one mile. The driving-wheels being 5 feet in diameter, their circumference was 15.7 feet, and consequently in passing over a mile they would have revolved 336.3 times. Since each revolution consumes four cylinders full of steam, the quantity of steam supplied by the boiler to the cylinders per mile will be found by multiplying the contents of the cylinder by four times 336.3, or 1,345.2.

The cylinders of the Hecla were $12\frac{1}{2}$ inches in diameter, and 18 inches in length, and consequently their contents were 1.28 cubic feet for each cylinder: this being multiplied by 1,345.2 gives 1,721.86 or 1,722 cubic feet of steam per mile. It appears, therefore, that supposing the priming either nothing or insignificant, which was considered to be the case in these experi-

ments, 3.36 cubic feet of water produced 1,722 cubic feet of steam, of the density worked in the cylinders. The ratio, therefore, of the volume of this steam to that of the water producing it, was 1,722 to 3.36, or 512.5 to 1. The pressure of steam of this density would be 54.5 pounds per square inch. Such, therefore, was the limit of the average total pressure of the steam in the cylinders. In this experiment the safety-valve of the boiler was screwed down to 60 pounds per square inch above the atmospheric pressure, which was therefore, the major limit of the pressure of steam in the boiler; but as the actual pressure in the boiler must have been less than this amount, the difference between the pressure in the cylinder and boiler could not be ascertained. This difference, however, would produce no effect on the moving power of the steam, since the pressure of steam in the cylinders obtained by the above calculation is quite independent of the pressure in the boiler, or of any source of error except what might arise from priming. The pressure of 54.5 pounds per square inch, calculated above, being the total pressure of the steam on the pistons, let 14.5 pounds be deducted from it, to represent the atmospheric pressure against which the piston must act, and the remaining 40 pounds per square inch will represent the whole available force drawing the train and overcoming all the resistances arising from the machinery of the engine, including that of the blast-pipe. The magnitude of a 12½-inch piston being 122.7 square inches, the total area of the two pistons would be 245.2 square inches, and the pressure upon each of 40 pounds per inch would give a total force of 9,816 on the two pistons. Since this force must act through a space of three feet, while the train is impelled through a space of 15.7 feet, it must be reduced in the proportion 3 to 15.7, to obtain its effect at the point of contact of the wheels upon the rails: this will give 1,875 pounds as the total force exerted in the direction of the motion of the train. The gross weight of the train being 80 tons, including the engine and tender, this would give a gross moving force along the road of about 23.4 pounds per ton of the gross load, this force being understood to include all the resistances due to the engine. This resistance corresponds to the gravitation of a plane rising at the rate of $\frac{1}{95}$, and therefore it appears that such would be the inclination of the plane by the gravitation of which the gross resistance would be doubled, instead of such inclination being about $\frac{1}{300}$, as has been hitherto supposed.

Since the remarkable and unexpected results of this series of experiments became known various circumstances were brought to light, which were before unnoticed, and which abundantly confirm them. Among these may be mentioned the fact, that in descending the Madeley plane, on the grand junction railway, which falls for above three miles at the rate of twenty-nine feet a mile, the steam can never be entirely cut off. But, on the other hand, to maintain the necessary speed in descending, the power of the engine is always necessary. As this plane greatly exceeds that which would be sufficient to cause the free motion of the train down it, the power of the engine expended in descending it, besides all that part of the gravitating power of the plane which exceeds the resistance due to friction and other mechanical causes must be worked against the atmosphere.

This estimate of the resistance is also in conformity with the results of a variety of experiments made by me with trains of different magnitudes down inclined planes of various inclinations.

In laying out a line of railway the disposition of the gradients should be such as to preserve among them as uniform a character as is practicable, for the weight and power of the engine must necessarily be regulated by the general steepness of the gradients. Thus if upon a railway which is generally level, like that between Liverpool and Manchester, one or two inclined planes

of a very steep character occur, as happens upon that line, then the engine which is constructed to work upon the general gradients of the road is unfit to draw the same load up those inclinations which form an exception to the general character of the gradients. In such cases some extraordinary means must generally be provided for surmounting those exceptionable inclinations. Several expedients have been proposed for this purpose, among which the following may be mentioned:—

1. Upon arriving at the foot of the plane, the load is divided, and the engine carries it up in several successive trips, descending the plane unloaded after each trip. The objection to this method is the delay which it occasions—a circumstance which is incompatible with a large transport of passengers. From what has been stated, it would be necessary, when the engine is fully loaded on a level, to divide its load into two or more parts, to be successively carried up when the incline rises 52 feet per mile. This method has been practised in the transport of merchandise occasionally, when heavy loads were carried on the Liverpool and Manchester line, upon the Rainhill incline.

2. A subsidiary or assistant locomotive-engine may be kept in constant readiness at the foot of each incline, for the purpose of aiding the different trains, as they arrive, in ascending. The objection to this method is the cost of keeping such an engine with its boiler continually prepared, and its steam up. It is necessary to keep its fire continually lighted, whether employed or not; otherwise, when the train would arrive at the foot of the incline, it should wait until the subsidiary engine was prepared for work. In cases where trains would start and arrive at stated times, this objection, however, would have less force. This method is at present generally adopted on the Liverpool and Manchester line.

3. A fixed steam-engine may be erected on the crest of the incline, so as to communicate by ropes with the train at the foot. Such an engine would be capable of drawing up one or two trains together, with their locomotives, according as they would arrive, and no delay need be occasioned. This method requires that the fixed engine should be kept constantly prepared for work, and the steam continually up in the boiler.

4. In working on the level, the communication between the boiler and the cylinder in the locomotives may be so restrained by partially closing the throttle-valve, as to cause the pressure upon the piston to be less in a considerable degree than the pressure of steam in the boiler. If, under such circumstances, a sufficient pressure upon the piston can be obtained to draw the load on the level, the throttle-valve may be opened on approaching the inclined plane, so as to throw on the piston a pressure increased in the same proportion as the previous pressure in the boiler was greater than that upon the piston. If the fire be sufficiently active to keep up the supply of steam in this manner during the ascent, and if the rise be not greater in proportion than the power thus obtained, the locomotive will draw the load up the incline without further assistance. It is, however, to be observed, that in this case the load upon the engine must be less than the amount which the adhesion of its working-wheels with the railroad is capable of drawing; for this adhesion must be adequate to the traction of the same load up the incline, otherwise, whatever increase of power might be obtained by opening the throttle-valve, the drawing-wheels would revolve without causing the load to advance. This method has been generally practised upon the Liverpool and Manchester line in the transport of passengers; and, indeed, it is the only method yet discovered which is consistent with the expedition necessary for that species of traffic.

In the practice of this method, considerable aid may be derived also by suspending the supply of feeding-water to the boiler during the ascent. It will

be recollected that a reservoir of cold water is placed in the tender which follows the engine, and that the water is driven from this reservoir into the boiler by a forcing-pump, which is worked by the engine itself. This pump is so constructed that it will supply as much cold water as is equal to the evaporation, so as to maintain constantly the same quantity of water in the boiler. But it is evident, on the other hand, that the supply of this water has a tendency to check the rate of evaporation, since in being raised to the temperature of the water with which it mixes it must absorb a considerable portion of the heat supplied by the fire. With a view to accelerate the production of steam, therefore, in ascending the inclines, the engine-man may suspend the action of the forcing-pump, and thereby stop the supply of cold water to the boiler; the evaporation will go on with increased rapidity, and the exhaustion of water produced by it will be repaid by the forcing-pump on the next level, or still more effectually on the next descending incline. Indeed, the feeding-pump may be made to act in descending an incline, if necessary, when the action of the engine itself is suspended, and when the train descends by its own gravity, in which case it will perform the part of a brake upon the descending train.

5. The mechanical connexion between the piston of the cylinder and the points of contact of the working-wheels with the road may be so altered, upon arriving at the incline, as to give the piston a greater power over the working-wheels. This may be done in an infinite variety of ways, but hitherto no method has been suggested sufficiently simple to be applicable in practice; and even were any means suggested which would accomplish this, unless the intensity of the impelling power were at the same time increased, it would necessarily follow that the speed of the motion would be diminished in exactly the same proportion as the power of the piston over the working-wheels would be increased. Thus, on the inclined plane, which rises fifty-five feet per mile, upon the Liverpool line, the speed would be diminished to nearly one fourth of its amount upon the level.

THE END.

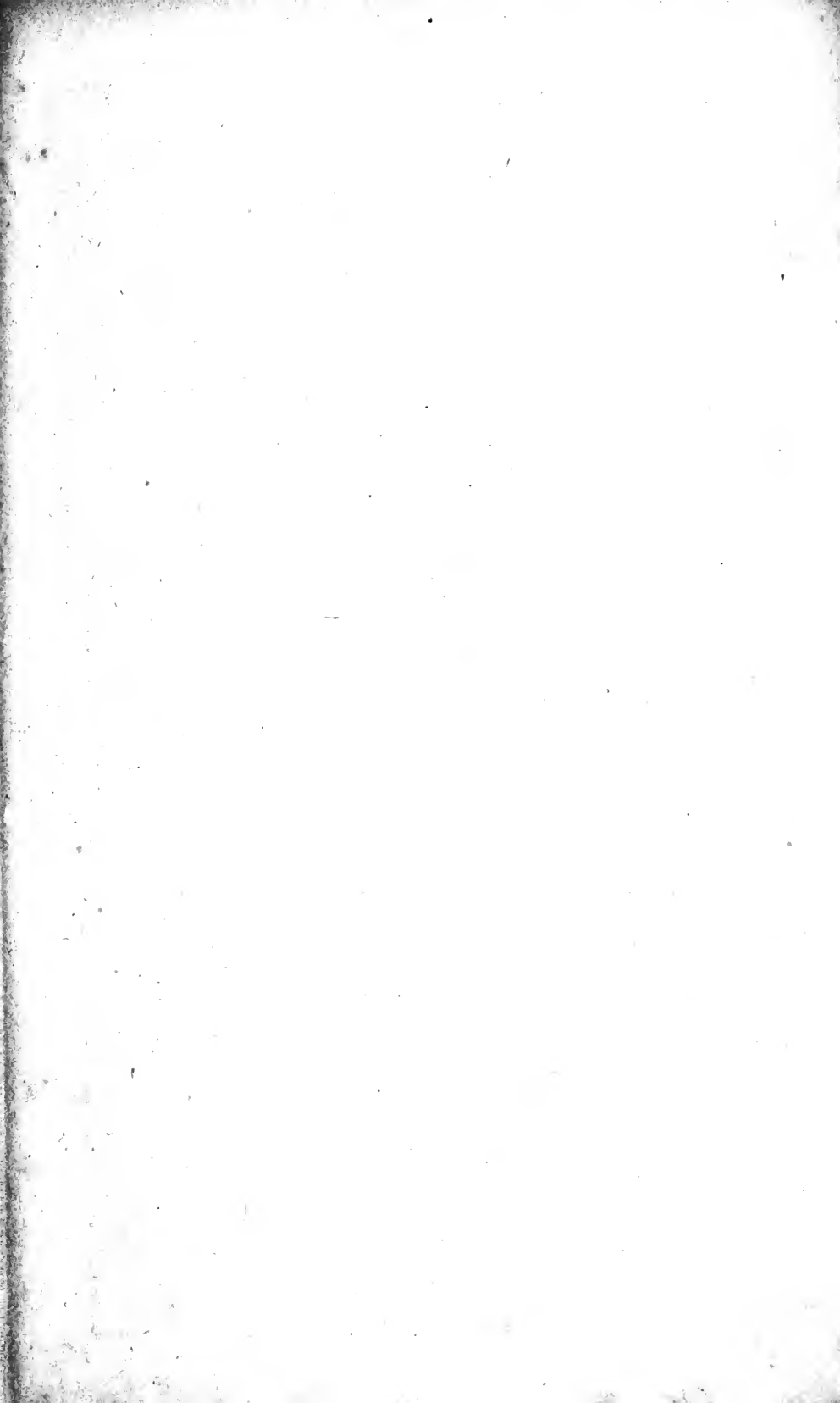

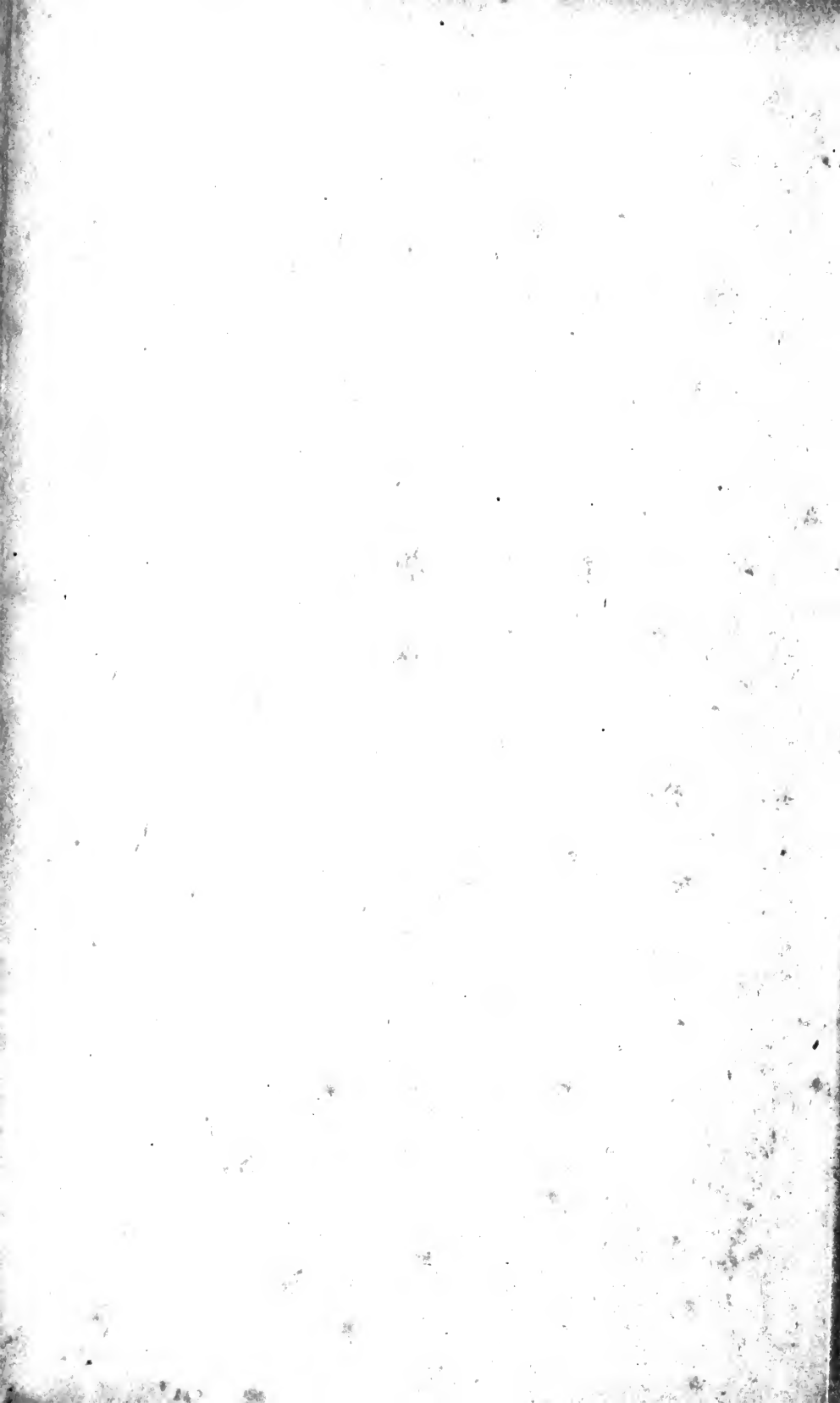

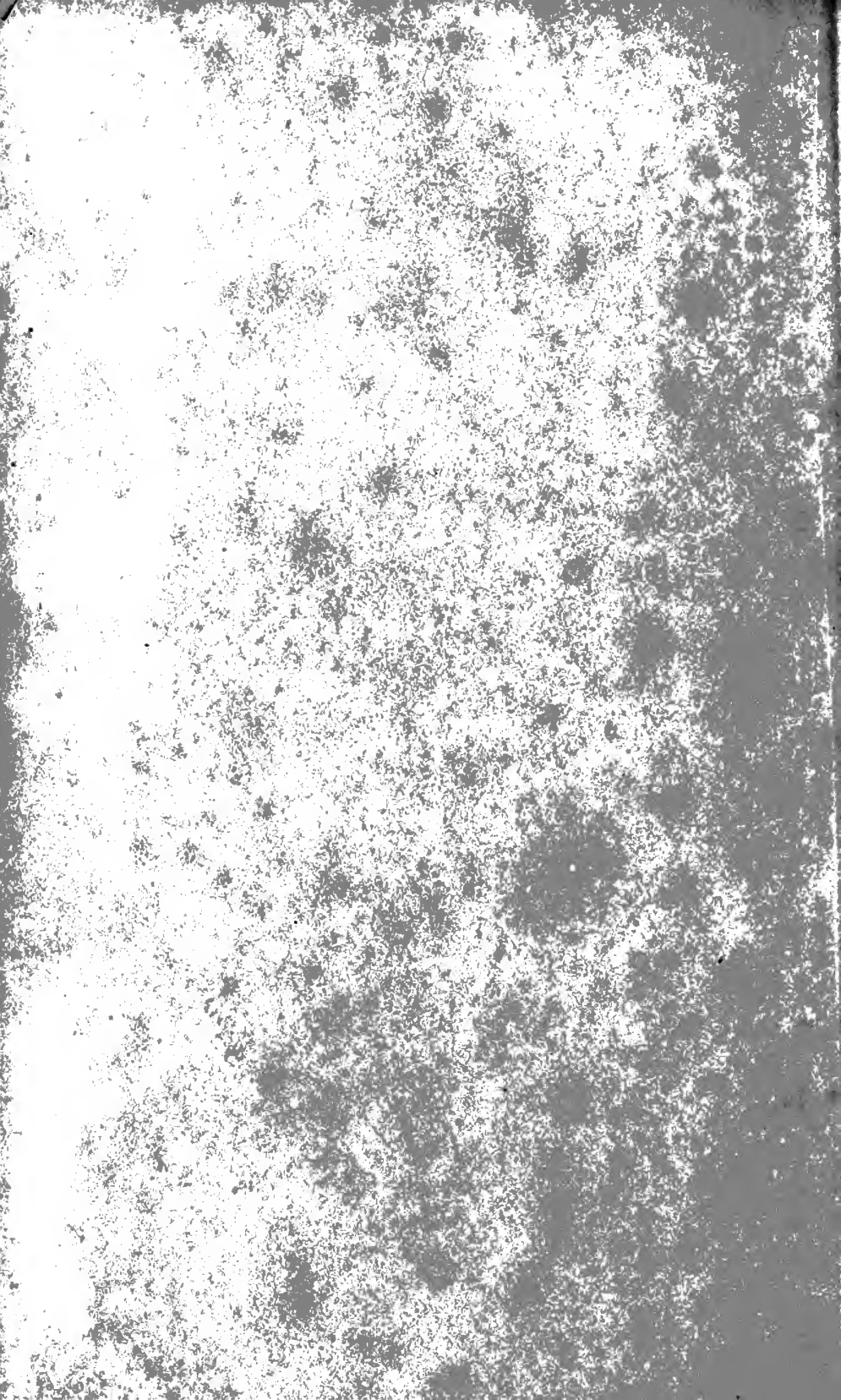

69



Q Lardner, Dionysius
171 Popular lectures on
L35 science and art
1859
v.2

P&ASci

PLEASE DO NOT REMOVE
CARDS OR SLIPS FROM THIS POCKET

UNIVERSITY OF TORONTO LIBRARY

AUG 1 6 1971

